

Chevs of the 40's

2007 Edition Truck Catalog

Order:
1-800-999-CHEV (2438)
1-360-816-0211
\$4.25



*World's most complete supplier of 1937-54
Chevrolet car & truck parts*



Fax: 1-800-888-CHEV (2438)

Shop online: www.chevsofthe40s.com

Welcome to Chevs of the 40's shopping!

To our Valued Customers:

For 26 years we have been providing the best in restoration parts for 1937-54 Chevrolet Cars & Trucks. We continue to expand our inventory of hard-to-find restoration parts while improving our selection of Street Rod Parts. We strive to provide the best in *service, quality and variety of parts* needed for your vehicle—from a complete restoration to full-blown street machine. We have an easy to use **Illustrated Index** in the front of our catalog to make finding parts easy along with an alphabetical **Parts Index** in the back.

Street Rod parts can now be found in our new STREET ROD HEADQUARTERS catalog. You may contact us for it or visit www.STREETRODHQ.com

Thanks for your business!
Ron Wade
CEO/Owner

How to order

ONLINE: Order anytime by accessing our online catalog from our website www.chevsofthe40s.com. Credit card information is secure and we don't sell our customer database to anyone.

CALL: 1-800-999-CHEV (2438)

Our sales reps are available to assist you 7 a.m.–5 p.m., Pacific Time.

Weekend & After-hours:

Our lovable voice mail takes your orders.

Existing customers—Simply provide your name & customer number off your catalog label, vehicle year, series and body style, credit card number (if appropriate), part numbers with descriptions, and quantities.

New customers—Please give all of the above vehicle information as well as your phone (in case we have a question about the order) and complete address including zip code.

FAX (order form in back):
1-800-888-CHEV (2438)
Local: 1-360-816-0215

How to pay

Use **CHECK BY PHONE** to achieve prompt shipping (10 days faster than mailing a check.) And, because it helps reduce our costs, our reward to you is a **4% discount** on parts when you place your **FIRST** electronic-check order by phone. *Try it—it's convenient and secure!*

CHECKS BY MAIL are welcome; however the accounting department may hold your order on uncertified funds. *At company discretion, a mailed-in check may be converted to an electronic check.*

Returned checks will be charged an NSF fee.

CREDIT CARDS: Visa, MasterCard and Discover are welcome!

How we ship

RATES: Our software computes the correct shipping and handling charges using **the best method, unless you specify a carrier.** *If your UPS and US Postal address are different, make sure your salesperson has both addresses in your file.*

NOTE: If paying by check, please estimate your shipping charges as follows: \$0-\$100: \$2.50 plus 14% of parts cost. Over \$100: \$16.50 plus 6% of amount over \$100. Or call for shipping and product price verification.

The computer system will adjust your order for any freight differences. When purchasing **oversized** parts, some can be shipped via UPS and others need to be sent via truck freight collect so please call for rates!

SHIPPING TIME on ground deliveries takes 2 to 14 days depending your location. For faster service options, when placing the order, please ask your sales person for an **express delivery quote.**

Most orders ship the same day!

SALES TAX is calculated on order total (including shipping) for any order shipped to an address in the state of Washington. The current sales tax rate is 8.2%.

How problems are handled

DAMAGE CLAIMS: If a package appears to be damaged upon delivery, open the package with the delivery driver and have them note any damages. **You** must report damage claims to carriers (UPS, etc.) within **5 days** of receipt. The carrier contacts us and returns the package for replacement. **Do not** ship to Chevs of the 40's.

SHORTAGES: All orders are scanned with a bar code reader before shipping. If, in the unlikely event, a shipment error occurs—CALL US IMMEDIATELY!

BACKORDERS: Our computerized inventory system allows us to maintain tight control on our stocking levels. However, we do not have control over our *suppliers*. Back orders are not charged until they ship. Shipment occurs immediately when we receive the part.

Returns/Exchanges:

Made-to-order items, such as glass, are **non-returnable.** **All other parts** (*excluding Odds & Ends*) may be returned within **30 days.** Return parts in the original condition received. CODs *will not* be accepted.

1. Have your invoice ready
2. Call 1-800-999-CHEV (2438)
3. Obtain authorization number
4. Write the number on the outside of the package and on a copy of the invoice.
5. Include invoice copy in package.

Remember: Shipping can take up to 14 days, so allow 3-4 weeks on returns. Warranty applies only to purchase price of item or replacement of part.

Unfortunately, *credit card companies* no longer credit your credit cards for returns after 90 days. Therefore, we will issue in-store credits or a refund check.

How to earn \$300!

Get your car featured in a national publication, mention Chevs of the 40's as your quality parts source, include our phone number and address, send us the article and...start thinking of how to spend your \$300 store credit at **Chevs of the 40's!**

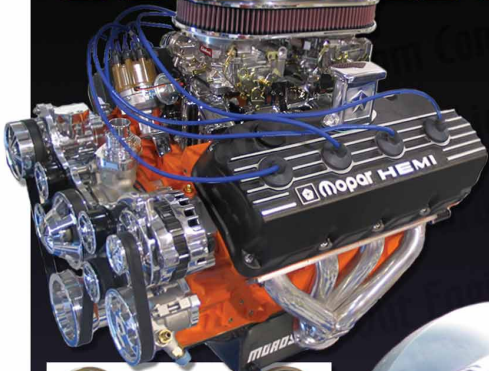
Notice: All prices are subject to change without notice.

Also due to the possibility of human error, we reserve the right not to sell any item at a misprinted price or description.

For all your street rod parts visit us on-line or call to order our 2007 Street Rod Headquarters catalog. We offer many parts for many vehicles

\$5.00 USD

Street Rod Headquarters



2007 Edition Catalog



*toll free order line:
800-952-1752*



www.StreetrodHQ.com



1941 Cabriolet—Ron Wade, Owner, Chev's of the 40's



Ron Wade's National Vintage Chevrolet Club of America's Best of Show 1941 Cabriolet has over 50 accessories: Air filter-oil bath, antenna-reel, armrest-center, back-up light, beauty rings, clock-electric, compass, cowl vent knob-ivory, crank support-front bumper, crank-hand, defroster, driving lights, emergency brake whistle, exhaust tip-sharks tail, fender skirts, flashlight, fold-down rear guard, foot scraper, gas cap-GM locking, GM caroma, grill-winterguard, grill guard-bumper, heater-super deluxe, hood

ornament-flying lady, horn-town & country, initial holder, license frames, mirror-day/night, mirror-lighted vanity, mirror-right, oil filter, passing lights, radiator screen-outside, radiator-overflow tank, radio-AM and 4-band short wave, radio-pocket portable, rear axle 3.70, rear fender guards, spare tire inflator, spotlight-left and right, steering wheel-spinner, thermometer, tire pump, tires-whitewall, tool kit, turn signals, umbrella-silk, valve cover breather, visor-clip-on, washboards-front fender, wheel disks, and windshield washers.

Returns require a return authorization number, please call.

Illustration Index

Street Rod Parts

Chevs of the 40's is a proud distributor of many of the premier street rod parts providers. We are very excited about the continuing expansion of our inventory to provide for the street rod market as well as continuing the availability of parts for the restorer. As always, if you need any assistance our top-notch sales staff is available on the phone to answer any of the tougher questions.

Core charge information

All core charges are refundable when we receive your rebuildable unit in exchange. Please remove all external parts and brackets.

Part number information

Group and part numbers are original GM when applicable so you may refer to Chev parts book for questions.

Exceptions

Suffix "A"—part not originally available by itself.

Suffix "B"—not originally available as an assembly. Other suffixes, not originally available by itself or is a modified part.

If you have an addition or correction for this catalog, please give us a call. We want to provide the best possible service for you!

Illustration Index

Absolute Essentials Kit.....	16
Axle—Front & Rear	125
Brake Parts.....	107
Bumper.....	141
Camshaft	27, 28
Chassis.....	6
Clutch, Drive Shaft and Rear End	95
Complete Bed.....	7
Complete Truck Bed Order Form	224
Crankshaft	27, 28
Crate Engines.....	25, 26
Custom Wheels	135
Door Assembly	205
Driving, Fog and Spot Lights	68
Electrical System.....	5
Engine Assembly.....	27, 28
Engine ID Chart.....	29
Engine Kits	30
Exhaust System.....	92
Exterior	6
Front & Rear Suspension	
Kits	129–130
Gauges—Classic Instruments ...	190
Glass	5, 213
Headlamp	68
Horn Contact Parts	116
IFS Suspension Kits	129–132
Interior	4
Knobs	184
Modular Fuse Panel System	61
Paint Combination Chart	11
Radio with CD.....	198
Rubber.....	5
Sheet Metal	7
Springs.....	125
Starter and Related.....	50
Steering Gear	115
Suspension Kits.....	129–132
Taillamp	68
Transmissions	97
Truck Body Parts	159–171
Window Channel	218
Window Riser Knobs	184
Windshield Wipers.....	184

Number ID, Production #'s, Paint & Trim Charts (Sect. 5T, 8T)

Gifts, Tools, Insulation, Paints, Solvents, Adhesives, Car Covers (Sect. 10T, 12T, 15T)

Engine Parts, Gaskets, Mounts (Sect 20T, 22T, 24T, 26T)

Cooling, Heating (Sect 30T, 35T)

Engine Electrical, Starters, Alternators, Ignition (Sect 40T, 45T, 50T, 55T)

Electrical (Sect 60T)

Lighting (Sect 80T, 85T, 90T, 100T, 110T)

Fuel, Exhaust (Sect 120T, 130T)

Clutch, Transmission, Driveline, Rear Axle (Sect 140T, 150T, 160T, 170T)

Brakes, Steering (Sect 180T, 190T)

Suspension, Wheels, Hubcaps, Bearings (Sect 200T, 205T, 210T, 220T)

Bumpers, Grills, Hood (Sect 230T, 240T, 250T)

Fenders, Running Boards, Step Plates (Sect 270T, 290T)

Body, Sheet Metal, Mounts (Sect 295T, 300T)

Firewall, Floorboard, Interior (Sect 310T, 320T, 330T)

Dash, Mirrors, Radio, Wipers (Sect 340T, 345T, 350T, 360T, 370T)

Doors (Sect 380T, 390T, 400T)

Window: Glass & Rubber (Sect 420T, 430T, 440T, 450T, 460T, 470T, 480T)

Complete Beds & Parts (Sect 490T)

Manuals, Tags, Decals, Photos (Sect 520T, 530T, 550T, 560T)

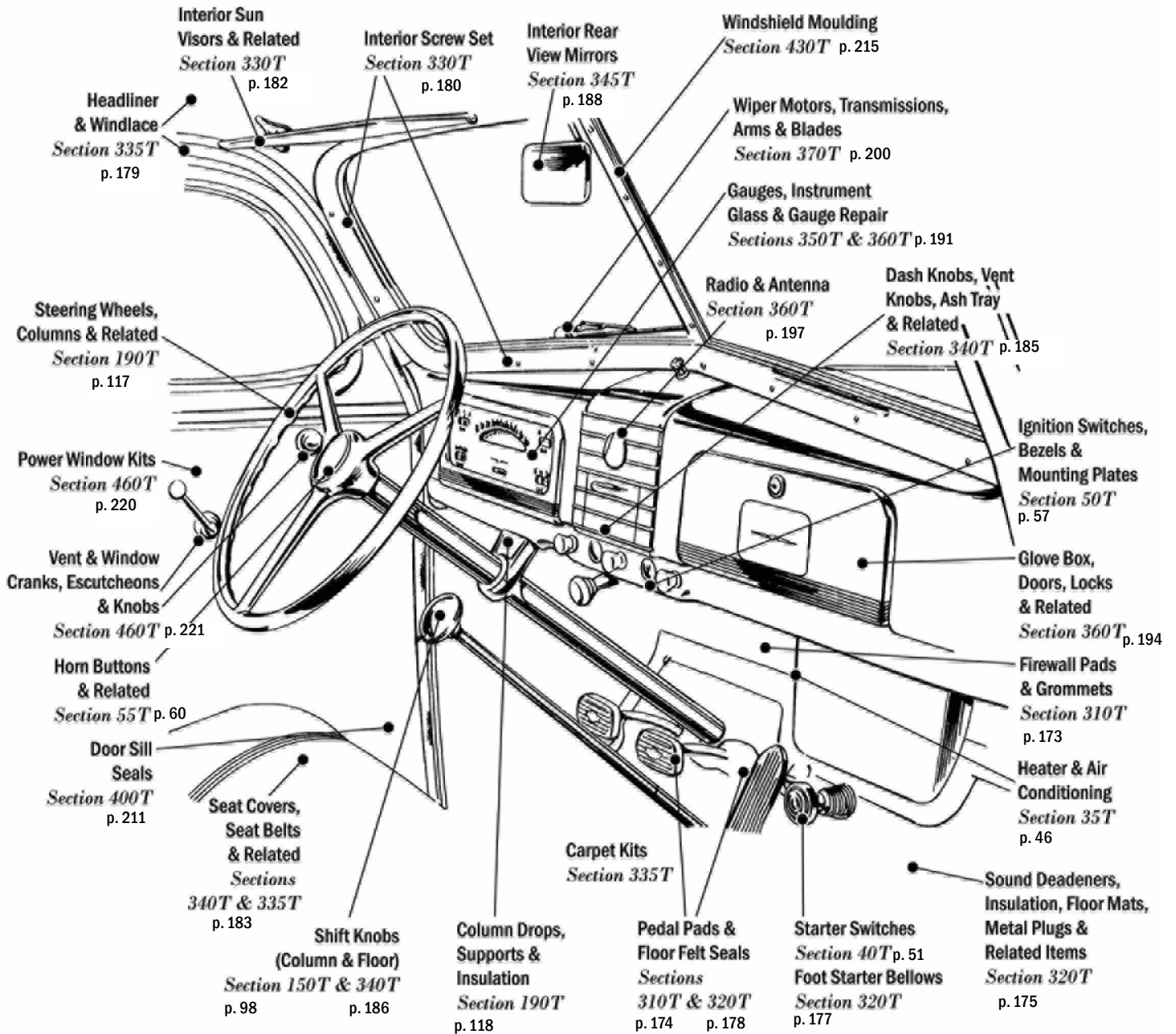
Providing part #'s speeds up your order, improves accuracy, and helps us maintain low prices.

See Illustration Index for core charge information and a list of abbreviations. For Body Model information, see 5T.



Picture Table of Contents—Interior

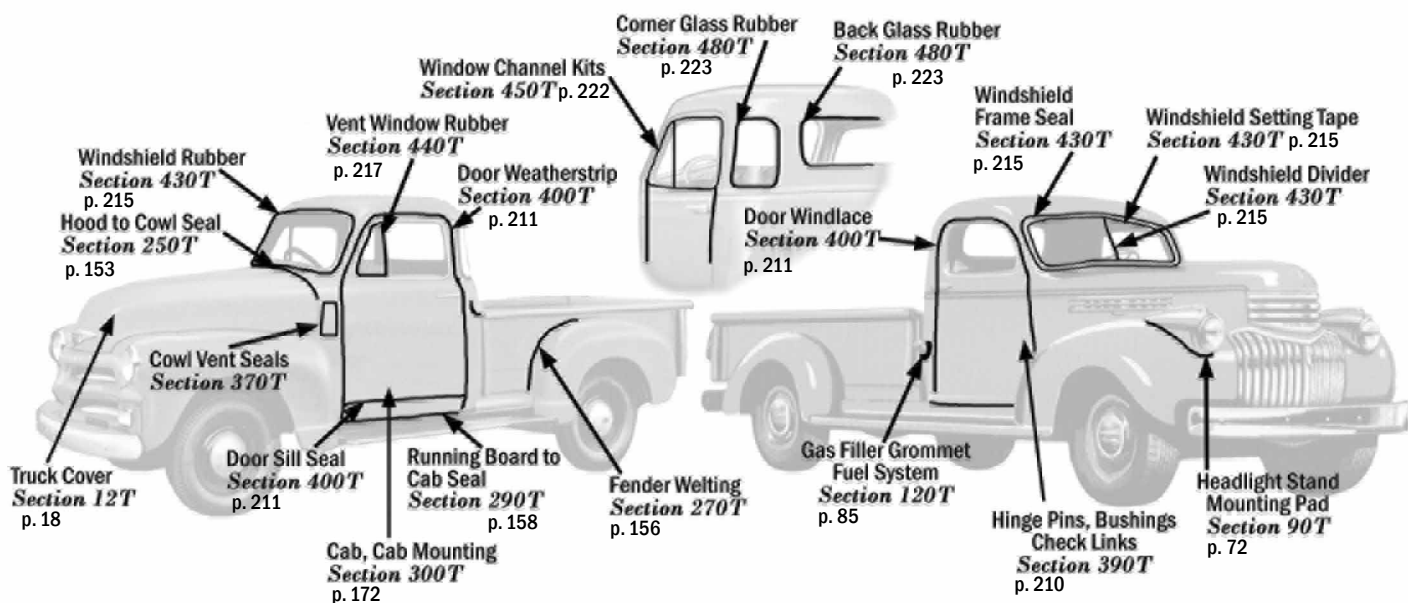
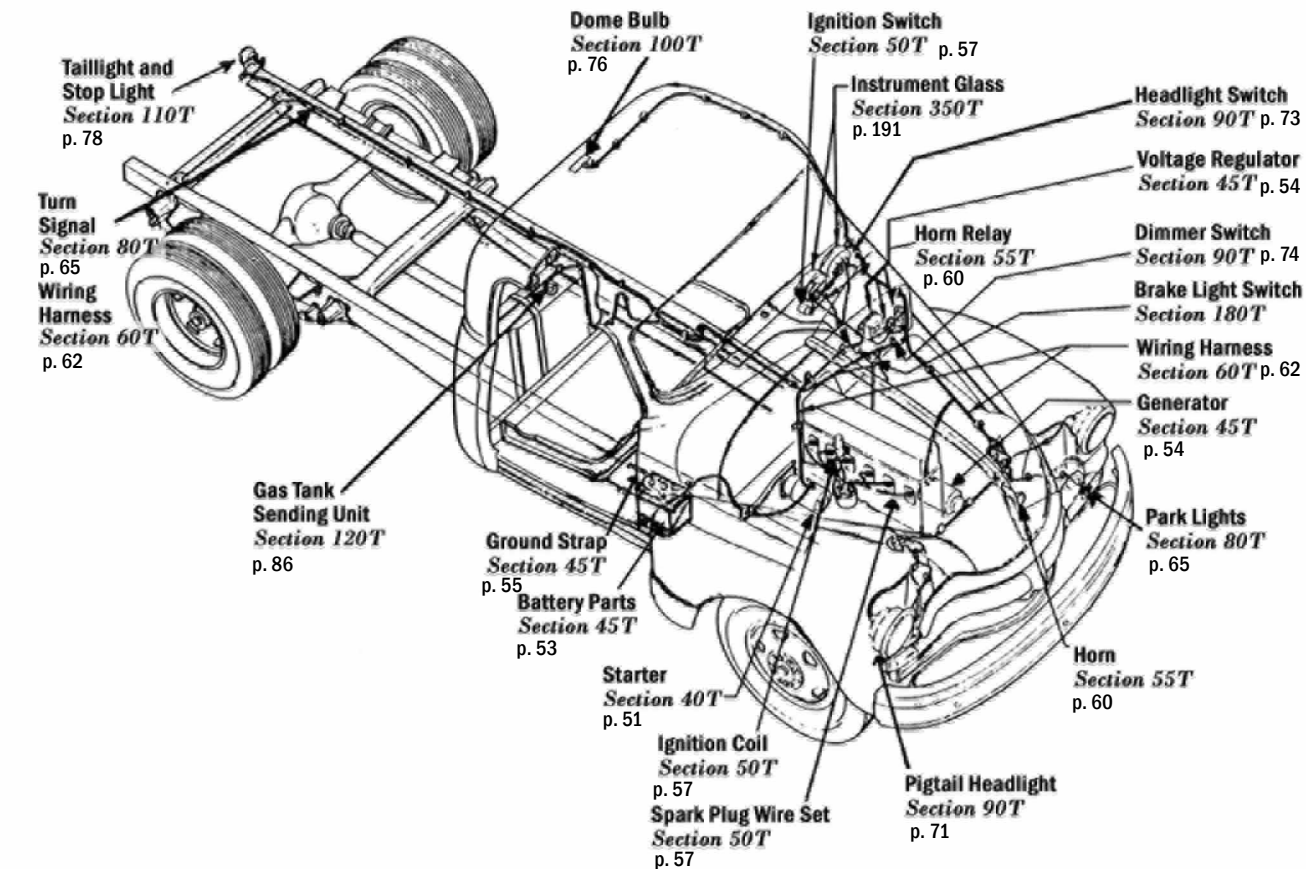
We show major parts. To find the component, find the part your item is related to. Example: Hood Ornament = Hood, Tie Rod End = Steering.



Returns require a return authorization number, please call.

Picture Table of Contents—Electrical System, Glass and Rubber

We show major parts. To find the component, find the part your item is related to. Example: Hood Ornament = Hood, Tie Rod End = Steering.



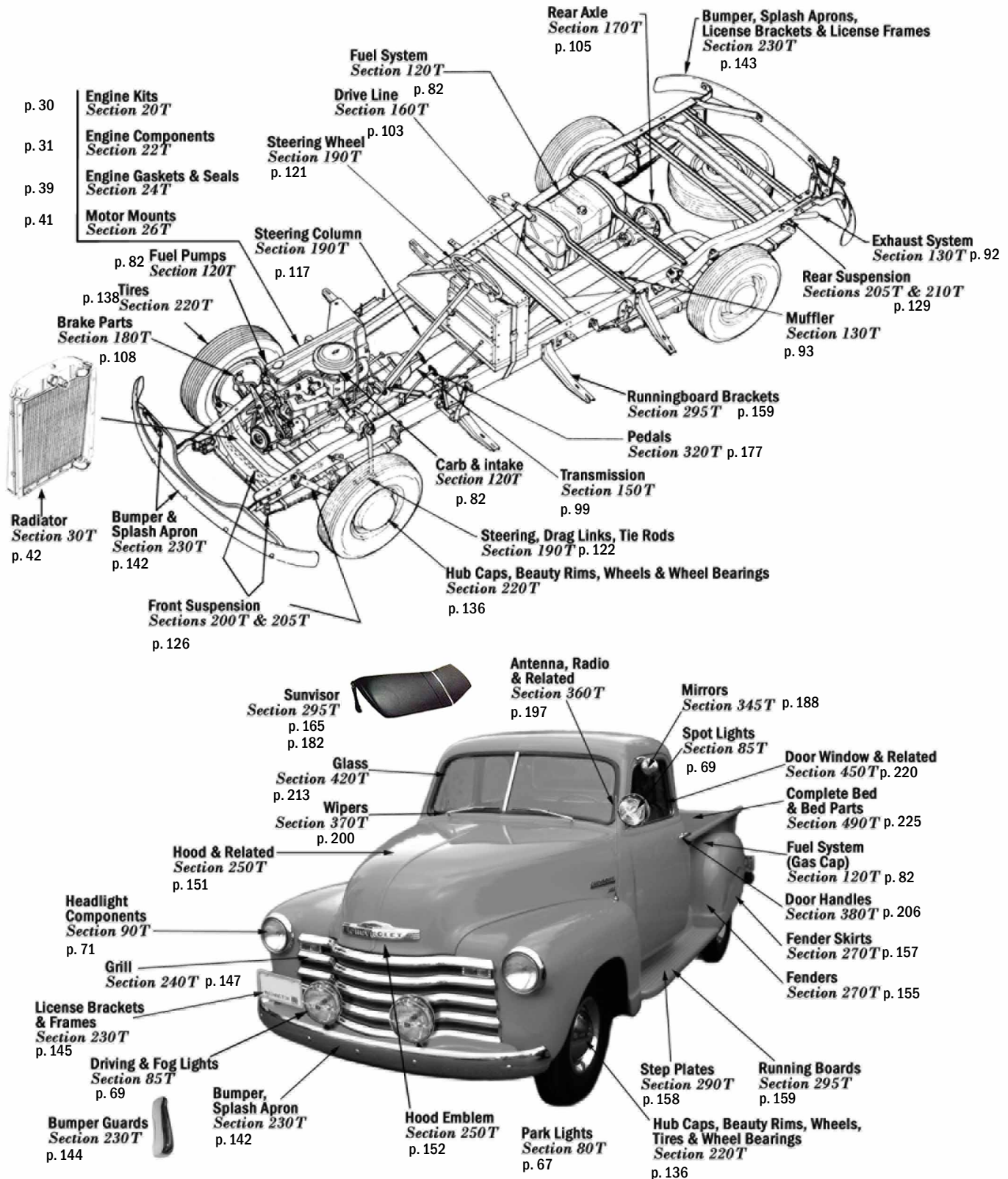
Providing part #'s speeds up your order, improves accuracy, and helps us maintain low prices.

See Illustration Index for core charge information and a list of abbreviations. For Body Model information, see 5T.



Picture Table of Contents—Chassis and Exterior

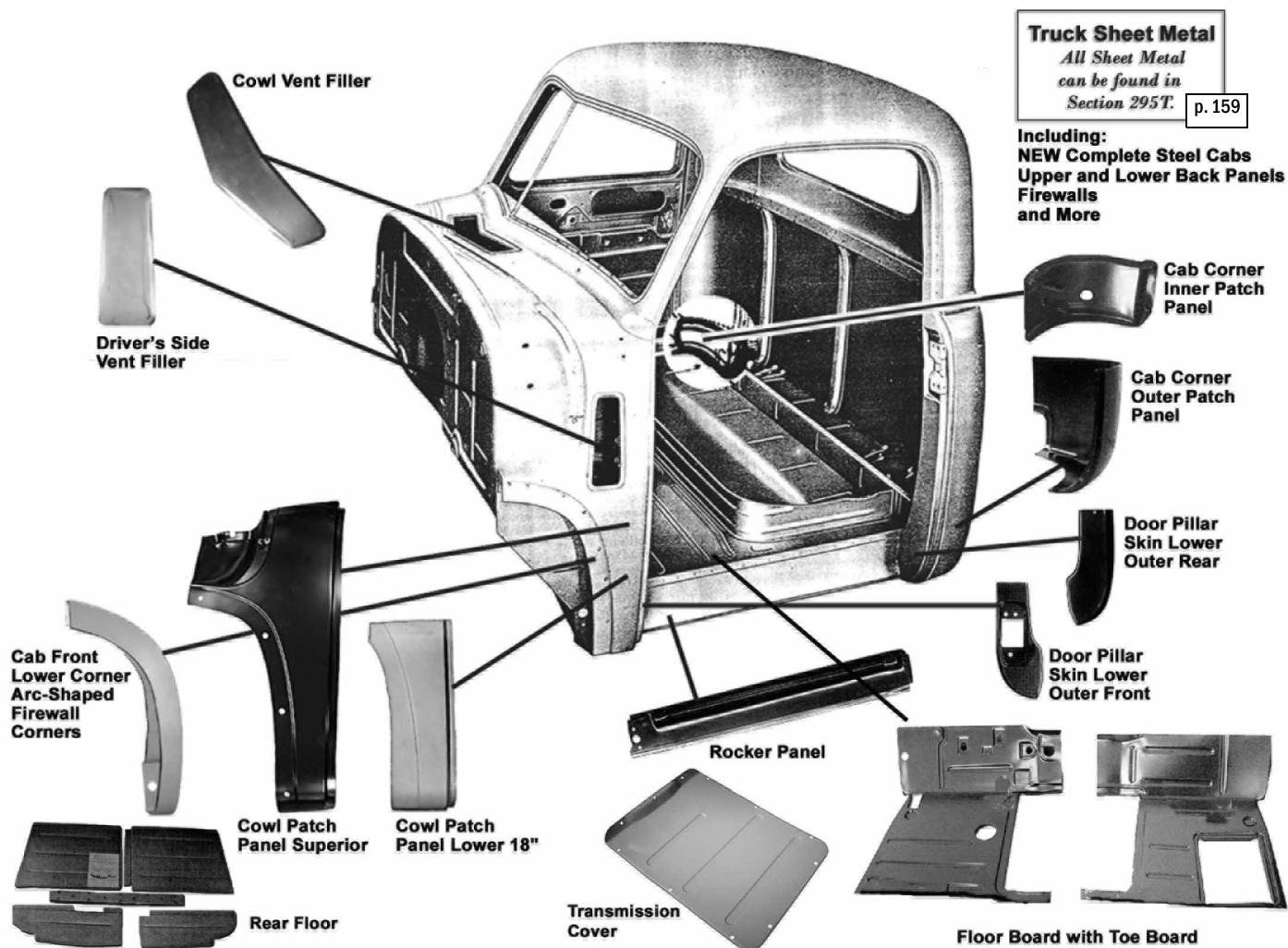
We show major parts. To find the component, find the part your item is related to. Example: Hood Ornament = Hood, Tie Rod End = Steering.



Returns require a return authorization number, please call.

Picture Table of Contents—Sheet Metal and Complete Bed

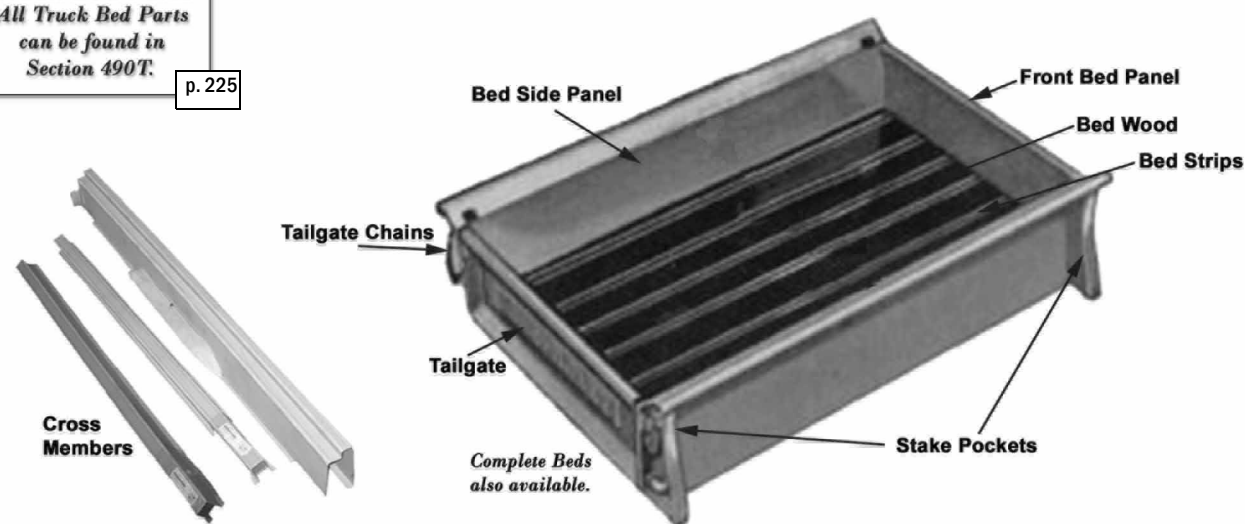
We show major parts. To find the component, find the part your item is related to. Example: Hood Ornament = Hood, Tie Rod End = Steering.



Truck Sheet Metal
All Sheet Metal can be found in Section 295T. p. 159

Including:
NEW Complete Steel Cabs
 Upper and Lower Back Panels
 Firewalls
 and More

Truck Bed Parts
All Truck Bed Parts can be found in Section 490T. p. 225





5T: Series Identification Table

Series Wheelbase Type of Vehicle

1937

GA	112-1/4	Passenger (Master De Luxe) with Knee Action (Enclosed Type)
GB	112-1/4	Passenger and Sedan Delivery (Master)
GC	112	Commercial—1/2 Ton Truck
GD	122-1/4	Commercial—3/4 Ton Truck, 11 in. Brakes
GE	122-1/4	Commercial—1 Ton Truck
SA	131-1/2	Utility—1-1/2 Ton Truck, Single Wheels
SB	131-1/2	Utility—1-1/2 Ton Truck, Dual Wheels
SC	157	Utility—1-1/2 Ton Truck, Single Wheels
SD	157	Utility—1-1/2 Ton Truck, Dual Wheels

1938

HA	112-1/4	Passenger (Master De Luxe) with Knee Action (Enclosed Type)
HB	112-1/4	Passenger and Sedan Delivery (Master)
HC	112	Commercial—1/2 Ton Truck
HD	112-1/4	Commercial—3/4 Ton Truck, 11 in. Brakes
HE	112-1/4	Commercial—1 Ton Truck, 14 in. Brakes
TA	131-1/2	Utility—1-1/2 Ton Truck, Single Wheels
TB	131-1/2	Utility—1-1/2 Ton Truck, Dual Wheels
TC	157	Utility—1-1/2 Ton Truck, Single Wheels
TD	157	Utility—1-1/2 Ton Truck, Dual Wheels

1939

JA	112-1/4	Passenger (Master De Luxe) with Knee Action (Open Spring Type)
JB	112-1/4	Passenger and Sedan Delivery (Master 85)
JC	113-1/2	Commercial—1/2 Ton Truck
JD	123-3/4	Commercial—3/4 Ton Truck, 11 in. Brakes
JE	123-3/4	Commercial—1 Ton Truck, 14 in. Brakes (Heavy Duty)
VA	133	Utility—1-1/2 Ton Truck, Single Wheels
VB	133	Utility—1-1/2 Ton Truck, Dual Wheels
VC	158-1/2	Utility—1-1/2 Ton Truck, Single Wheels
VD	158-1/2	Utility—1-1/2 Ton Truck, Dual Wheels
VE	107-5/8	Utility—Cab Over Engine, Single Wheels
VF	107-5/8	Utility—Cab Over Engine, Dual Wheels
VG	131-1/8	Utility—Cab Over Engine, Single Wheels
VH	131-1/8	Utility—Cab Over Engine, Dual Wheels
VM	156-5/8	Utility—Cab Over Engine, Single Wheels
VN	156-5/8	Utility—Cab Over Engine, Dual Wheels

1940

KA	113	Passenger (Special De Luxe) with Knee Action (Open Spring Type)
KH	113	Passenger (Master De Luxe) with Knee Action (Open Spring Type)
KB	113	Passenger and Sedan Delivery (Master 85), Conventional Front Axle
KC	113-1/2	Commercial—1/2 Ton Truck
KD	123-3/4	Commercial—3/4 Ton Truck, 11 in. Brakes
KE	123-3/4	Commercial—3/4 Ton Truck, 14 in. Brakes, Heavy Duty
KF	133	Commercial—1 Ton Truck
WA	133	Utility—1-1/2 Ton Truck, Single or Dual Wheels

Series Wheelbase Type of Vehicle

1940, continued

WB	158-1/2	Utility—1-1/2 Ton Truck, Single or Dual Wheels
WV	193-5/8	Utility—School Bus Chassis, Dual Wheels
WD	107-5/8	Utility—Cab Over Engine
WE	131-1/8	Utility—Cab Over Engine
WF	156-5/8	Utility—Cab Over Engine

1941

AH	116	Passenger (Special De Luxe) with Knee Action (Open Spring Type)
AG	116	Passenger and Sedan Delivery (Master De Luxe) with Knee Action (Open Spring Type)
AK	115	Commercial—1/2 Ton Truck
AL	125-1/4	Commercial—3/4 Ton Truck, 11 in. Brakes
AM	125-1/4	Commercial—3/4 Ton Truck, 14 in. Brakes, Heavy Duty
AN	134-1/2	Commercial—1 Ton Truck
YR	134-1/2	Utility—1-1/2 Ton Truck, Single or Dual Wheels
YS	160	Utility—1-1/2 Ton Truck, Single or Dual Wheels
YT	195	Utility—School Bus Chassis, Dual Wheels
YU	109	Utility—Cab Over Engine
YV	132-1/2	Utility—Cab Over Engine
YW	158	Utility—Cab Over Engine

1942

BH	116	Passenger (Special De Luxe)
BG	116	Passenger and Sedan Delivery (Master De Luxe)
BK	115	Commercial—1/2 Ton Truck
BL	125-1/4	Commercial—3/4 Ton Truck, 11 in. Brakes
BM	125-1/4	Commercial—3/4 Ton Truck, 14 in. Brakes
BN	134-1/2	Commercial—1 Ton Truck
MR	134-1/2	Utility—1-1/2 Ton Truck, Single or Dual Wheels
MS	160	Utility—1-1/2 Ton Truck, Single or Dual Wheels
MY	160	Utility—School Bus Chassis, Dual Wheels
MT	195	Utility—School Bus Chassis, Dual Wheels
MU	109	Utility—Cab Over Engine
MV	132-1/2	Utility—Cab Over Engine
MW	158	Utility—Cab Over Engine

First Design Second Design Wheelbase Type of Vehicle

1946

DK		116	Passenger (Fleetmaster and Fleetline)
DJ		116	Passenger (Stylemaster)
CK	DP	115	Commercial—1/2 Ton Truck
	DR	125-1/4	Commercial—3/4 Ton Truck
	DS	134-1/2	Commercial—1 Ton Truck
OR	PJ	134-1/2	Utility—1-1/2 Ton Truck
OS	PK	160	Utility—1-1/2 Ton Truck
OW	PL	160	Utility—School Bus Chassis

Returns require a return authorization number, please call.

5T: Series Identification Table



First Design	Second Design	Wheelbase	Type of Vehicle
--------------	---------------	-----------	-----------------

Series	Wheelbase	Type of Vehicle
--------	-----------	-----------------

1946, continued			
OY		195	Utility—School Bus Chassis
OE	PV	134-1/2	Utility—2 Ton Truck
OF	PW	160	Utility—2 Ton Truck
OG	PX	195	Utility—School Bus Chassis
OH	PP	109	Utility—2 Ton Truck, Cab Over Engine
OI	PR	132-1/2	Utility—2 Ton Truck, Cab Over Engine
OJ	PS	158	Utility—2 Ton Truck, Cab Over Engine

1949, continued			
GU	3900	137	Commercial—1 Ton Truck (Dubl-Duti), Forward Control Delivery Chassis
SJ	4100	137	Utility—1-1/2 Ton Truck
SK	4400	161	Utility—1-1/2 Ton Truck
SL	4500	161	Utility—School Bus Chassis
SV	6100	137	Utility—2 Ton Truck
SW	6400	161	Utility—2 Ton Truck
SX	6700	199	Utility—School Bus Chassis
SP	5100	110	Utility—2 Ton Truck, Cab Over Engine
SR	5400	134	Utility—2 Ton Truck, Cab Over Engine
SS	5700	158	Utility—2 Ton Truck, Cab Over Engine

First Design	Wheelbase	Type of Vehicle
--------------	-----------	-----------------

1947		
EK	116	Passenger (Fleetmaster and Fleetline)
EJ	116	Passenger (Stylemaster)
EP	116	Commercial Type of Vehicles
ER	125-1/4	Commercial—3/4 Ton Truck
ES	137	Commercial—1 Ton Truck
QJ	137	Utility—1-1/2 Ton Truck
QK	161	Utility—1-1/2 Ton Truck
QL	161	Utility—School Bus Chassis
QV	137	Utility—2 Ton Truck
QW	161	Utility—2 Ton Truck
QX	199	Utility—School Bus Chassis
QP	110	Utility—2 Ton Truck, Cab Over Engine
QR	134	Utility—2 Ton Truck, Cab Over Engine
QS	158	Utility—2 Ton Truck, Cab Over Engine

1950			
HK	2100	115	Passenger (Deluxe), Styleline and Fleetline
HJ	1500	115	Passenger (Special), Styleline and Fleetline
HP	3100	116	Commercial—1/2 Ton Truck
HR	3600	125-1/4	Commercial—3/4 Ton Truck
HT	3700	125-1/4	Commercial—3/4 Ton Truck (Dubl-Duti), Forward Control Delivery Chassis
HS	3800	137	Commercial—1 Ton Truck
HU	3900	137	Commercial—1 Ton Truck (Dubl-Duti), Forward Control Delivery Chassis
TJ	4100	137	Utility—1-1/2 Ton Truck
TK	4400	161	Utility—1-1/2 Ton Truck
TL	4500	161	Utility—School Bus Chassis
TV	6100	137	Utility—2 Ton Truck
TW	6400	161	Utility—2 Ton Truck
TY	6500	179	Utility—2 Ton Truck
TX	6700	199	Utility—School Bus Chassis
TP	5100	110	Utility—2 Ton Truck, Cab Over Engine
TR	5400	134	Utility—2 Ton Truck, Cab Over Engine
TS	5700	158	Utility—2 Ton Truck, Cab Over Engine

1948		
FK	116	Passenger (Fleetmaster and Fleetline)
FJ	116	Passenger (Stylemaster)
FP	116	commercial—1/2 Ton Truck
FR	125-1/4	Commercial—3/4 Ton Truck
FT	125-1/4	Commercial—3/4 Ton Truck (Dubl-Duti), Forward Control Delivery Chassis
FS	137	Commercial—1 Ton Truck
FU	137	Commercial—1 Ton Truck (Dubl-Duti), Forward Control Delivery Chassis
RJ	137	Utility-1-Utility—1-1/2 Ton Truck
RK	161	Utility-1-Utility—1-1/2 Ton Truck
RL	161	Utility—School Bus Chassis
RV	137	Utility—2 Ton Truck
RW	161	Utility—2 Ton Truck
RX	199	Utility—School Bus Chassis
RP	110	Utility—2 Ton Truck, Cab Over Engine
RR	134	Utility—2 Ton Truck, Cab Over Engine
RS	158	Utility—2 Ton Truck, Cab Over Engine

1951			
JK	2100	115	Passenger (Deluxe), Styleline and Fleetline
JJ	1500	115	Passenger (Special), Styleline and Fleetline
JP	3100	116	Commercial—1/2 Ton Truck
JR	3600	125-1/4	Commercial—3/4 Ton Truck
JT	3700	125-1/4	Commercial—3/4 Ton Truck (Dubl-Duti), Forward Control Delivery Chassis
JS	3800	137	Commercial—1 Ton Truck
JU	3900	137	Commercial—1 Ton Truck (Dubl-Duti), Forward Control Delivery Chassis
UJ	4100	137	Utility—1-1/2 Ton Truck
UK	4400	161	Utility—1-1/2 Ton Truck
UL	4500	161	Utility—School Bus Chassis
UV	6100	137	Utility—2 Ton Truck
UW	6400	161	Utility—2 Ton Truck
UY	6500	179	Utility—2 Ton Truck
UX	6700	199	Utility—School Bus Chassis
UP	5100	110	Utility—2 Ton Truck, Cab Over Engine
UR	5400	134	Utility—2 Ton Truck, Cab Over Engine
US	5700	158	Utility—2 Ton Truck, Cab Over Engine

1949			
GK	2100	115	Passenger (Deluxe), Styleline and Fleetline
GJ	1500	115	Passenger (Special), Styleline and Fleetline
GP	3100	116	Commercial—1/2 Ton Truck
GR	3600	125-1/4	Commercial—3/4 Ton Truck
GT	3700	125-1/4	Commercial—3/4 Ton Truck (Dubl-Duti), Forward Control Delivery Chassis
GS	3800	137	Commercial—1 Ton Truck

1952			
KK	2100	115	Passenger (Deluxe), Styleline and Fleetline
KJ	1500	115	Passenger (Special), Styleline and Fleetline

Providing part #'s speeds up your order, improves accuracy, and helps us maintain low prices.

See Illustration Index for core charge information and a list of abbreviations. For Body Model information, see 5T.



5T: Series Identification Table

Series	Wheelbase	Type of Vehicle
--------	-----------	-----------------

1952, continued

KP	3100	116	Commercial—1/2 Ton Truck
KR	3600	125-1/4	Commercial—3/4 Ton Truck
KT	3700	125-1/4	Commercial—3/4 Ton Truck (Dubl-Duti), Forward Control Delivery Chassis
KS	3800	137	Commercial—1 Ton Truck
KU	3900	137	Commercial—1 Ton Truck (Dubl-Duti), Forward Control Delivery Chassis
VJ	4100	137	Utility—1-1/2 Ton Truck
VK	4400	161	Utility—1-1/2 Ton Truck
VL	4500	161	Utility—1-1/2 Ton, School Bus Chassis
VV	6100	137	Utility—2 Ton Truck
VW	6400	161	Utility—2 Ton Truck
VY	6500	179	Utility—2 Ton Truck
VX	6700	199	Utility—2 Ton Truck, School Bus Chassis
VZ	6800	212	Utility—2 Ton Truck, School Bus Chassis
VP	5100	110	Utility—2 Ton Truck, Cab Over Engine
VR	5400	134	Utility—2 Ton Truck, Cab Over Engine
VS	5700	158	Utility—2 Ton Truck, Cab Over Engine

1953-54

A	1500	115	Passenger (One Fifty), excluding 1508
B	2100	115	Passenger (Two Ten)
C	2400	115	Passenger (Bel Air)
D	1508	115	Sedan Delivery
H	3100	116	Commercial—1/2 Ton Truck
J	3600	124-1/4	Commercial—3/4 Ton Truck
K	3700	124-1/4	Commercial—3/4 Ton Truck (Dubl-Duti), Forward Control Delivery Chassis
L	3800	137	Commercial—1 Ton Truck
M	3900	137	Commercial—1 Ton Truck (Dubl-Duti), Forward Control Delivery Chassis
N	4100	137	Utility—1-1/2 Ton Truck
P	4400	161	Utility—1-1/2 Ton Truck
R	4500	161	Utility—School Bus Chassis
S	5100	110	Utility—2 Ton Truck, Cab Over Engine
T	5400	134	Utility—2 Ton Truck, Cab Over Engine
U	5700	158	Utility—2 Ton Truck, Cab Over Engine
V	6100	137	Utility—2 Ton Truck
W	6400	161	Utility—2 Ton Truck
X	6500	179	Utility—2 Ton Truck
Y	6700	199	Utility—School Bus Chassis
Z	6800	212	Utility—School Bus Chassis

Returns require a return authorization number, please call.

10 Phone: (360) 816-0211 • (800) 999-CHEV (2438) • www.chevsofthe40s.com

8T: Paint Combination Chart



Format = Part No., Year, Description, original Chevrolet Part Book Group No., Price and Unit Measure.

Body		Moulding		Stripe	
1937-39					
242	Swifts Commercial Red	225	—	Argent Silver	2894202
243	Export Blue	314	—	Argent Silver	2894202
244	Brewster Green Medium	267	—	Gigolo Green	2899862
1940-46					
242	Swifts Commercial Red		Black Duco	2072122	Argent Silver
269	Boatswain Blue		Argent Silver	2894202	Totem Scarlet
257	Apple green		Cream Medium	2896596	Emerald Green
312	Amour Yellow		Omaha Orange	2896276	Moulding Black
234	Cream Medium		Export Blue	2897128	Argent Silver
314	Export Blue		Argent Silver	2894202	Totem Scarlet
262	Omaha Orange		Chess Blue	28950666	White Striping
313	Aluminum (Silver)		Totem Scarlet	28950165	Moulding Black
Most Common Colors					
			1940 uses Cream Medium		1940 uses Emerald Green
	Brewster Green		Kildaire Green	28950701	Emerald Green
	Black		Emerald Green	2893133	Cream Medium
			1940 uses Omaha Orange		1940 uses Chess Blue
264	White		Kildaire Green	28950701	White Striping
301	Hollywood Tan (Oakland Plant)		Moulding Black	2072122	White Striping
	Bordeaux Maroon (Terrytown & Baltimore Plants)		Moulding Black	2072122	Gold Bronze Powder
Upper Body	Lower Body	Moulding		Stripe	
1941-46 Suburban					
	Airdale Brown	Circassion Brown	Kildaire Green	28950701	White Striping
					289008
Body	Moulding		Stripe		
1947-49					
	Fathom Green		—		—
1947-53					
	Windsor Blue		—		—
	Cape Maroon		—		—
	Swift Red (Commercial Red)		—		—
	Armour Yellow		—		—
	Sun Beige		—		—
	Forester Green		—		—
	Seacrest Green		—		—
1947-55					
	Omaha Orange (GMC)		—		Jet Black
	Cream Medium		—		Jet Black
	Mariner Blue		—		Cream Medium
	White		—		Juniper Green
1948-49					
	Channel Green		—		—
1951-55					
	Yukon Yellow		—		Jet Black
	Burgundy Maroon		—		Gold Bronze
	Copper Tone		—		Shell White
	Ocean Green		—		Jet Black
	Autumn Brown		—		Shell White
	Transport Blue		—		Cream Medium
	Juniper Green		—		Cream Medium

Providing part #'s speeds up your order, improves accuracy, and helps us maintain low prices.

See Illustration Index for core charge information and a list of abbreviations. For Body Model information, see 5T.



10T: Gift Items, Collectibles, Truck Covers & Vehicle Maintenance

Part No., Year, Description, original Chevrolet Part Book Group No., Price and Unit Measure.

Turntable



TURNTABLE

Electric rotating vehicle display. Vehicle hovers over ground. Rotates at 0.6 rpm max. Safety stop for the slightest bump or obstruction. Easy to setup and transport. (00.000-15)
\$4,950.00 EA

Beanie Bear

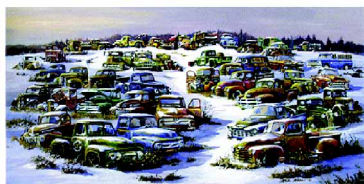


BEANIE

Licensed GM Chevrolet beanie bear available in blue, gray, green, orange or white. Specify color when ordering. (09.981-15)
\$7.00 EA

Artwork

Complement your office, den, garage or living room with these prints of classic Chevrolet vehicles. All are limited print runs.



ART1

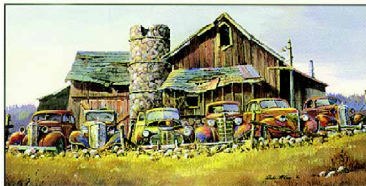
Hauler Heaven. 15in. X 30in. color print of trucks. Limited print run of 750. See if you can find your favorite truck. (00.000-15)
\$75.00 EA



ART2

Hillside Chevs. 17.5in. X 30in. color print of classic Chevs from ragtops to panels. Limited print run of 950 (00.000-15)
\$75.00 EA

Artwork



ART3

Chevy Farm. 15in. X 30in. color print of classic cars. Limited print run of 650. (00.000-15)
\$65.00 EA



ART4

Fifties Junkpile. 32in. X 23in. color print of cars. Limited print run of 1500. See if you can find your favorite GM vehicle from the 50s. (00.000-15)
\$95.00 EA

Stool with Backrest



STOOLPB

Chevrolet Parts stool. Yellow, red and blue swivel seat with backrest and chrome legs. 30 inch height. (00.000-15)
\$120.00 EA



STOOLSB

Chevrolet Service stool. Blue and white swivel seat with backrest and chrome legs. 30 inch height. (00.000-15)
\$120.00 EA

Stool without Backrest



STOOLP

Chevrolet Parts stool. Yellow, red and blue swivel seat with chrome legs. 30 inch height. (00.000-15)
\$90.00 EA

Stool without Backrest



STOOLS

Chevrolet Service stool. Blue and white swivel seat with chrome legs. 30 inch height. (00.000-15)
\$90.00 EA

Plastic Block

Scaled engine. Plastic block w/ steel inserts allow you to bolt on actual parts such as valve covers, exhaust headers, front engine pieces, intake and more. Great for engine/ chassis setup, garage display, education, coffee table, etc. Add harmonic balancer to aid in checking front component clearances.



PAP-2020

Chevy SB, long block (00.000-15)
\$300.00 EA

PAP-2021

Chevy SB, short block (00.000-15)
\$300.00 EA

PAP-2041

Harmonic balancer for Chevy SB. Mount crank pulley for front end clearance. (00.000-15)
\$35.00 EA



PAP-2120

Chevy BB, long block (00.000-15)
\$400.00 EA

PAP-2121

Chevy BB, short block (00.000-15)
\$400.00 EA

PAP-2125

Harmonic balancer for Chevy BB. Mount crank pulley for front end clearance. (00.000-15)
\$35.00 EA

Returns require a return authorization number, please call.

10T: Gift Items, Collectibles, Truck Covers & Vehicle Maintenance



10T

Format = Part No., Year, Description, original Chevrolet Part Book Group No., Price and Unit Measure.

Scaled Truck-GM Factory Promo



88882
1950 Chev pickup-genuine GM. Specify color: cream medium or mariner blue (00.000-15)
\$24.00 EA

Model 1:18 Scale 1941 Cabriolet



MODEL03CR
Die cast with opening doors, hood, trunk, functioning steering wheel and Free Wheeling Action. Choose Cream, Red, Blue or Black (00.000-15)
\$19.00 EA



MODEL07
Satin Black, retro rod 41 Chev Cabriolet. Die cast with opening doors, hood, trunk, functioning steering wheel and Free Wheeling Action. (00.000-15)
\$20.00 EA

Model 1:24-1:27 Scale 1941 Cabriolet



MODEL06
41 Chev Cabriolet. Die cast with opening doors & trunk. Choose color: Cream, Black, Red or Blue (00.000-0)
\$9.00 EA

Model 1:18 Scale 1948 Woody



MODEL02
48 Chev Fleetmaster Woody. Die cast with opening doors, hood, functioning steering wheel and Free Wheeling Action. Choose color: Black, Dark Brown, Light Blue or Gray (00.000-0)
\$19.00 EA

Model 1:24-1:27 Scale 1953 Truck



MODEL04
53 Chev 3100 Truck. Die cast with opening doors & tailgate. Choose color: Yellow, Black, Medium Red or Blue (00.000-2)
\$9.00 EA

Model 1:24-1:27 Scale 1948 Low Rider Woody



MODEL08
Die cast with opening doors & hood. Choose color: Black, Red, Green or Yellow. (00.000-15)
\$9.00 EA

Watches

Each watch comes packaged in a collectible tin gift box with Chevrolet logo and 3 year limited warranty.



WATM03
White face, Mens Chevrolet logo multi-function (3-eye) watch with stainless steel band. Day/ Date function, glow in the dark hour & minute hands and water resistant to 100 feet. (00.000-15)
\$52.00 EA



WATL02
Chevy sport, ladies w/ day/date stainless steel band (00.000-15)
\$42.00 EA



WATM01
Mens Gunmetal watch with calendar. Water resistant up to 100 feet. (00.000-15)
\$52.00 EA



WATL09
Ladies Route 66, metallic purple, radial dial watch. Stainless steel band. Water resistant case. (00.000-15)
\$32.00 EA

Providing part #'s speeds up your order, improves accuracy, and helps us maintain low prices.

See Illustration Index for core charge information and a list of abbreviations. For Body Model information, see 5T.



10T: Gift Items, Collectibles, Truck Covers & Vehicle Maintenance

Part No., Year, Description, original Chevrolet Part Book Group No., Price and Unit Measure.

Watches



WATM10
Quartz Calendar Mens Watch. Stainless Steel Band. Water resistant up to 30 meters. (00.000-15)
\$42.00 EA



WATL10
Quartz Calendar Womens Watch. Stainless Steel Band. Water resistant up to 30 meters. (00.000-15)
\$42.00 EA

WAT30
Quartz Calendar Mens Watch Stainless Steel Band. Water resistant up to 30 meters. (00.000-15)
\$42.00 EA



WATL06
Mens Chevrolet Autoglo watch with stainless steel band. Day function and water resistant to 100 feet. (00.000-15)
\$52.00 EA



WATL29
Quartz Calendar Mens Watch Stainless Steel Band. Water resistant up to 30 meters. (00.000-15)
\$42.00 EA



SHOWN WITH AUTOGLO "ON"

WATM06
Mens Chevrolet Autoglo watch with stainless steel band. Day function and water resistant to 100 feet. (00.000-15)
\$52.00 EA

Watches



WATM29
Quartz Calendar Mens Watch Stainless Steel Band. Water resistant up to 30 meters. (00.000-15)
\$42.00 EA

Clocks: 20-Inch Diameter

Neon to light up your garage, den, workshop or anywhere you can find a place for these large clocks. Limited 1 year warranty.



CLOCKN02
Super Chevrolet Service, blue trim, large neon wall clock. 5.5in. thick. On/ off pull chain. (00.000-15)
\$249.00 EA



CLOCKN01
Genuine Chevrolet, yellow trim, large neon wall clock. 5.5in. thick. On/ off pull chain. (00.000-15)
\$249.00 EA



CLOCKN05
Genuine Chevrolet, blue trim, large neon wall clock. 5.5in. thick. On/ off pull chain. (00.000-15)
\$249.00 EA

Clocks: 20-Inch Diameter



CLOCKN03
OK, red trim, large neon wall clock. 5.5in. thick. On/ off pull chain. (00.000-15)
\$249.00 EA



CLOCKN04
Polly Gas, yellow trim, large neon wall clock. 5.5in. thick. On/ off pull chain. (00.000-15)
\$249.00 EA

Clocks: 14-3/4-Inch Diameter



CLOCK03W
White face Chevrolet clock. Chrome housing. Flashing red LED bowtie and blue circumference neon. 3 hand quartz movement. Electric neon, battery operated clock (00.000-15)
\$65.00 EA



CLOCK03B
Black face Chevrolet clock. Flashing red LED bowtie and blue circumference neon. 3 hand quartz movement. Electric neon, battery operated clock (00.000-15)
\$65.00 EA

Returns require a return authorization number, please call.

10T: Gift Items, Collectibles, Truck Covers & Vehicle Maintenance



10T

Format = Part No., Year, Description, original Chevrolet Part Book Group No., Price and Unit Measure.

Clocks: 14-3/4-Inch Diameter



CLOCK13
Route 66 dual color neon wall clock. Chrome housing. Main Street of America with Route 66 winged logo. Alternating blue & pink neon. 3 hand quartz movement. Electric neon, battery operated clock. (00.000-15)
\$80.00 EA

Clocks



CLOCK15
Chevrolet "Genuine Parts". 12-3/4" square. (00.000-15)
\$22.00 EA



CLOCK14
Route 66 square clock with LEDs along the way. Battery operated clock. (00.000-15)
\$58.00 EA



CLOCK06
Disc brake wall clock. 14-1/4in. Diameter with quartz movement. Blue LED lighted dial, wrench hour hand and screwdriver minute hand. Electric LED, battery operated clock (00.000-15)
\$42.00 EA



CLOCK04
Black face Chevy Trucks calendar wall clock. 13-3/4in. diameter gray plastic case with chrome-plated bezel. 3 hand quartz movement with day/ date calendar. (00.000-15)
\$52.00 EA

Clocks



CLOCK07
Tire neon wall clock. 14in. Diameter with quartz movement. Rubber tire outer housing, wrench hour hand, screwdriver minute hand. Blue neon tube (6 month warranty on tube) with rotor & caliper behind wheel. Electric neon, battery operated clock (00.000-15)
\$52.00 EA



CLOCK05
Chevrolet dual color neon wall clock. 15in. diameter with chrome housing. Blue & white neon. 3 hand quartz movement. Electric neon, battery operated clock. (00.000-15)
\$72.00 EA



CLOCK01S
Silver Weather Station wall clock. 12-3/4in. high X 10-3/4in. wide. Humidity and temperature gauges. 3 hand quartz movement. (00.000-15)
\$22.00 EA



CLOCK10
Chevy Belts & Pulleys wall clock. 12 1-4in. square, 2in. deep. Chrome bezel, gray plastic case and 3-hand quartz movement. Officially licensed GM product. (00.000-15)
\$22.00 EA

Clocks



CLOCK12
Disc brake rotor outer housing, wrench hour hand, screwdriver minute hand. Rotor spins when pedals are pressed. Plays race sounds to wake you up. Battery operated quartz clock. 4 3/4in. W X 5in. H. (00.000-15)
\$19.00 EA



CLOCK11
Quartz movement. Rubber tire outer housing (4 in. dia.), wrench hour hand, screwdriver minute hand with rotor & caliper behind wheel. Battery operated clock. Officially licensed GM product. (00.000-15)
\$12.00 EA

Duster



DUSTER
Cotton duster w/ handle and carrying case. Red, standard size. (08.800-15)
\$10.00 EA



DUSTER MINI
Cotton duster w/ handle. Red head, black handle in a compact size (12in. overall length). (08.880-15)
\$6.00 EA

Providing part #'s speeds up your order, improves accuracy, and helps us maintain low prices.

See Illustration Index for core charge information and a list of abbreviations. For Body Model information, see 5T.



10T: Gift Items, Collectibles, Truck Covers & Vehicle Maintenance

Part No., Year, Description, original Chevrolet Part Book Group No., Price and Unit Measure.

Washing and Detailing your car is easy, and provides instant gratification. We can help with complete car care kits or individual products.

THE DETAIL KIT TO END ALL DETAIL KITS

The Absolute Essentials Clean & Detail Kit: **\$130**

1. Ph-neutral Car Wash Soap
2. Wash Pad
3. Clay Bar
4. Detail Spray
5. VRT (Vinyl Rubber & Tire dressing)
6. Revive Polish
7. Butter Wax
8. Three Microfiber Polishing towels
9. Three Microfiber Applicator pads
10. Three Detail Sponges
11. Microfiber Drying Towel
12. 5 Gallon Bucket w/ Spin-off Lid
13. Instructional DVD
14. 1/2 Gallon Refill of Detail Spray
15. 12 oz. Leather Conditioner
16. 16 oz. Brilliant Spray Glaze



The Essentials Clean & Detail Kit: **\$99**



Includes signature high-suds, ph-neutral Car Wash Soap, Clay Bar, Detail Spray, VRT, Revive Polish, Scratch & Swirl Remover, Butter Wax, two microfiber towels, applicator pads, and detail sponges & plush wash pad. Packaged in a clear, 4-1/4 gallon detail bucket with spin-off, sealable lid (doubles nicely as stool). Save money with this kit over buying individual items.

Detail Spray



ADPG002
1 gallon (08.800-15)
\$35.00 EA

Spray Glaze

Add depth and clarity to chrome, glass and paintwork. Extreme ease of use with ultra-high gloss results. Not for use on oxidized finishes.



ADPD007
16 oz. Bottle
(08.800-15)
\$16.00 EA



ADPH007
1/2 gallon. (08.800-15)
\$35.00 EA



ADPG007
1 gallon (08.800-15)
\$50.00 EA

Car Wash

Adam's specially-formulated Car Wash Soap. pH-balanced, won't strip the protective coating off your finish. Biodegradable.



ADPD001
12 oz. Bottle
(08.800-15)
\$7.00 EA

ADPH001
1/2 gallon. (08.800-15)
\$16.00 EA



ADPG001
1 gallon (08.800-15)
\$25.00 EA

Detail Spray

We use this spray and it works! A waterless car wash, clay bar lubricant or to enhance the depth and clarity of paint, chrome, plastic, aluminum, and glass. Removes dirt, smudges and grime, leaving surfaces with a smooth, ultra-high gloss finish. Use in the sun or shade, and in hot or cool temperatures.



ADPD002
16 oz. Bottle
(08.800-15)
\$10.00 EA



ADPH002
1/2 gallon. (08.800-15)
\$25.00 EA

Clay Bar



ADPA001
Removes surface contamination safely and easily without skid or swirl marks. The large 4-oz bar is suitable for 8-10 vehicles. (08.800-15)
\$20.00 EA

Revive Polish



ADPD004
Removes moderate oxidation, swirl marks, and fading. Easy to remove. Will not stain rubber or plastic.. (08.800-15)
\$16.00 EA

Returns require a return authorization number, please call.



Format = Part No., Year, Description, original Chevrolet Part Book Group No., Price and Unit Measure.

Butter Wax

Contains special blend of polymers, resins and natural Carnuba without cleaners or abrasives and will not stain plastic or rubber. Use Clay Bar and Revive Polish on imperfect finishes before applying Butter Wax. 12-oz bottle covers many vehicles.



ADPD006
12 oz. Bottle
(08.800-15)
\$16.00 EA



ADPH006
1/2 gallon. (08.800-15)
\$35.00 EA

Swirl & Haze Remover



ADPT005
Not a rubbing compound and is less abrasive than toothpaste. Gently removes scratches from clearcoats and painted surfaces. For use by hand or machine. For best results, combine with Revive Polish.
(08.800-15)
\$9.00 EA

Rubber Dressing

Enhance & protect plastic, rubber, tires, moldings, dashboards and door panels. Applies easily with a sponge without a greasy film. Adds U.V. protection to keep vehicle interiors and exteriors looking and feeling like new.



ADPD003
12 oz. Bottle
(08.800-15)
\$10.00 EA

Rubber Dressing



ADPH003
1/2 gallon. (08.800-15)
\$25.00 EA

ADPG003
1 gallon (08.800-15)
\$40.00 EA

Applicator



ADPA003
Large washable sponge. Use to apply a thin, even coat of VRT without the mess.
(08.800-15)

\$5.00 SET



ADPM001
An essential ingredient in successful polishing, especially when done by hand. 4" x 6". Soft pad spreads a thin, even layer of polish or wax and features a durable sponge hand-sewn inside.
(08.800-15)

\$7.00 SET

Leather Conditioner



ADPD008
Nourish and condition leather upholstery with this thick, non-greasy cream. Contains U.V. blocking agents and will never dry your leather. Suitable for auto and home upholstery.
(08.800-15)

\$16.00 EA

Carpet & Upholstery Cleaner



ADPD011
Non-toxic, non-allergenic cleaner. Contains no soap and will not create suds, yet it magically removes spots and dirt from your floor mats and other carpeted areas and fabric upholstery.
(08.800-15)
\$7.00 EA

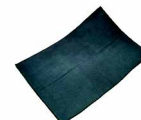
Plastic Detail Spray



THE TIME SAVER!
Quickly restore badly faded plastic, rubber, flat painted surfaces and AC vents to their original luster and shine. Makes detailing hard-to-reach areas a simple task. Non greasy, and easily wipes from paint and glass.
(08.800-15)
\$9.00 EA

Drying Towel

Waffle STARFIBER Jumbo Microfiber Drying Towel is the bath sheet of detailing towels. Measures a whopping 25" x 36". The waffle never streaks or scratches. Save over 30% when you buy two.



ADPM008
1 towel. (08.800-15)
\$20.00 EA



ADPM009
2 towels. (08.800-15)
\$35.00 SET

Providing part #'s speeds up your order, improves accuracy, and helps us maintain low prices.

See Illustration Index for core charge information and a list of abbreviations. For Body Model information, see 5T.



10T: Gift Items, Collectibles, Truck Covers & Vehicle Maintenance

Part No., Year, Description, original Chevrolet Part Book Group No., Price and Unit Measure.

Metal Polish



ADPD009

Bring back luster and shine on heavily oxidized parts without scratching. This pure liquid magic works wonders on stainless, brass, billet, chrome, and nickel. Follow with Polish #2 for additional shine and maintenance (for use on non-clear coated parts.)

(08.800-15)

\$12.00 EA



ADPD010

Contains no abrasives. Highest gloss metal polish on the market w/ effortless application. Keep a mirror-like finish on brass, stainless, billet, nickel, and chrome. Use with a microfiber pad for best results (for use on non clear-coated parts).

(08.800-15)

\$12.00 EA

Metal Polish & Sealer



ZOOPSEAL

Tired of polishing your wheels and trim? This product keeps all metals from dulling or oxidizing for up to 2 years, specifically aluminum, stainless and brass. Kit comes complete including video. Covers approx 75 sq ft. Spend more time cruising and less time polishing. Recommended by several publications. (08.800-15)

\$130.25 EA

Polishing Ball



POWERBALL

Use with your favorite polishing compound/ liquid on a drill/ screw gun to revitalize metal, plastic and more.

(08.800-15)

\$25.00 EA



POWERBALLM

Mini ball with extension for hard to reach areas.

(-15)

\$24.00 EA

Polishing Towel

Microfiber Polishing Towel is the softest, safest and most effective polishing towel on the market. Measuring 16" x 24", the thick yellow towel is ideal for removing polish and Detail Spray. We use two polishing towels for a standard detail.



ADPM002

Single Towel
(08.800-15)

\$6.00 EA

ADPM005

2 Pack. (08.800-15)

\$10.00 SET

ADPM006

4 Pack. (08.800-15)

\$20.00 SET

ADPM007

5 Pack. (08.800-15)

\$25.00 SET



ADPM003

6 Pack. (08.800-15)

\$30.00 SET

Truck Cover

FLANNEL: Soft, napped flannel to protect your finish. Woven covers constructed from durable polycotton blend. Breathable, rot & mildew resistant. Elastic at both ends for snug fit. **POLYCOTTON:** Basic vehicle protection. Sun & water resistant. Resists tears & punctures. Both types recommended for inside use only.



306800A

Polycotton, 1/2T short bed. (16.550-15)

\$190.00 EA

306803F

Flannel, 1/2T short bed. (16.550-15)

\$225.00 EA

306800T

Polycotton, long bed. (16.550-15)

\$205.00 EA

306804F

Flannel, long bed. (16.550-15)

\$240.00 EA



306800B

Storage bag.
(16.550-15)

\$10.00 EA



306800L

Lock set. (16.550-2)

\$15.00 EA

Returns require a return authorization number, please call.

12T: Tools, Adhesives, Brake Fluid, Gas Tank Prep & Sealer, Carburetor & Brake Cleaners and Polishers



12T

Format = Part No., Year, Description, original Chevrolet Part Book Group No., Price and Unit Measure.

Clutch Head Driver W/ Bits



DRIVER

Magnetic driver w/ 5 bits (1/8in., 5/32in., 3/16in., 1/4in., 5/16in.) with Chevs imprint. (08.821-15)

\$22.25 SET

Clutch Head Bits



3685598
1/8in. (1/4in. drive)
(08.821-3)
\$4.00 EA



3685592
5/32in. (1/4in. drive)
(08.821-4)
\$4.00 EA



3685594
3/16in. (1/4in. drive)
(08.821-3)
\$4.00 EA



3685593
1/4in. (1/4in. drive)
(08.821-3)
\$4.00 EA



3685595
5/16in. (1/4in. drive)
(08.821-2)
\$6.00 EA

Clutch Bit Holder



3685596
For your 1/4in. drive ratchet. Holds clutch head bits. (08.821-2)
\$6.00 EA

Tool Bag



986362

Tool bag. Superb reproduction w/ pictures of tools which may be found at swap meets. (08.821-15)

\$18.00 EA

Tools-Engine, Drivetrain



38352226 **37-53**
Used to align oil dipper troughs in pan (\$400 refundable deposit upon return of tool) (01.427-4)

\$35.00 RENT



838956A
To align clutch disc. (00.866-4)
\$7.00 EA



595005A **37-54**
Drive shaft bushing puller to rent (return in original condition for \$20 refund). (05.451-15)

\$40.00 EA

Tools-Body



010351
Removes mouldings (Amazing!) (08.821-15)
\$34.00 EA



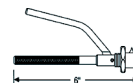
01832
To install windshield & back window rubber (exc 41-48 w/ mouldings) (08.821-3)
\$6.00 EA

Tools-Body



3847415T **42-54**
Inserts back glass rubber lock strip. (16.469-15)
\$23.50 EA

Tools-Interior



4088134A
Installs door handle ferrules. Return tool in same condition as sent for a \$20 refund (Does not work with Ferrule part #4125630). (10.537-15)
\$39.50 EA



4173376A **49-65**
Sets vent window pivot pin. (10.669-15)
\$5.00 EA

Battery Tender Plus

1.25 amp, Charges a battery and maintains it. Automatically switches from full charge to floating charge mode. Reverse Polarity Protection.



BT06V
6 Volt Charger (02.332-15)
\$60.00 EA
BT12V
12 Volt Charger (02.332-15)
\$60.00 EA

Providing part #'s speeds up your order, improves accuracy, and helps us maintain low prices.

See Illustration Index for core charge information and a list of abbreviations. For Body Model information, see 5T.



12T: Tools, Adhesives, Brake Fluid, Gas Tank Prep & Sealer, Carburetor & Brake Cleaners and Polishers

Part No., Year, Description, original Chevrolet Part Book Group No., Price and Unit Measure.

Battery Minder

1.33 max amp. Charger/ maintainer/ conditioner charges without overcharging. No sulphate build-up.



BM12V

12 Volt Charger (02.332-15)

\$50.00 EA

BM06V

6 Volt Charger (02.332-15)

\$50.00 EA

Fender Cover



989936B

Chevrolet text w/ Bowtie (19.980-15)

\$20.00 EA



989936H

with Heartbeat of America script.

(19.980-15)

\$21.50 EA

Oil Pad

OILPAD1

Place under vehicle to absorb oil, water, etc. Holds over 1 gallon. (3 ft x 5 ft).

(08.821-15)

\$22.00 EA

OILPAD

Place under vehicle to absorb oil, water, etc. Holds approx 1 gallon (3 ft x 3 ft)

(08.821-15)

\$16.00 EA

Gas Tank Restoration Kit



PORTANK

Restore and maintain gummed up tanks. Cleaner, metal prepsealer, fuel preservative/ stabilizer and complete instructions. (03.001-15)

\$65.00 EA

Gas Tank Cleaner

Works fast & makes petroleum-based cleaners nearly obsolete. Can be diluted with water up to 3, 4, 5 and even 10 times its volume while remaining more potent than other cleaners. Removes grease, oil, mildew, algae, musty odors, soap films & wax. Use it to clean canvas, vinyl, nylon, holding tanks, grease traps, auto parts and more.



PORCLEAN

1 quart. (03.001-15)

\$10.50 EA

Metal Prep

Provides adhesion for POR-15 paint (Sect. 15) on aluminum and shiny polished metal surfaces. Etches metal and leaves a zinc phosphate coating. Non-caustic, non-corrosive, non-toxic & non-flammable.



PORMETAL

Water based, OSHA approved biodegradable solution. 1 quart. (03.001-15)

\$15.75 EA

Gas Tank Sealer Slosh



3657942B

Seals gas tank. Recommended for new tanks. Impervious to all fuels. (03.001-15)

\$32.75 QT

Gas Tank Sealer Slosh



3657942C

Seals gas tank. Alcohol resistant.

Recommended for new tanks. (03.001-15)

\$24.25 QT

Fuel Stabilizer

Keep fuel fresh. Removes water, cleans carburetors & fuel injectors. Protects engine from gum, varnish, rust, and corrosion. Eliminates need to drain fuel before storage. Special dispenser bottles measure exactly without waste. Contains NO alcohol.



111801B

POR-15 stabilizer. Treats up to 48 gals (3 ozs. per gal). 1 pint. Treats for a minimum 2 years. (03.001-15)

\$11.25 EA



111801

STA-BIL stabilizer. 8 oz bottle treats 20 gallons. Treats up to 1 year (03.001-15)

\$7.25 EA

Rust Remover



1001PL

This works, is biodegradable and non-caustic. Sold as a concentrate that makes 3 gallons. (08.800-15)

\$30.00 EA

Returns require a return authorization number, please call.

12T: Tools, Adhesives, Brake Fluid, Gas Tank Prep & Sealer, Carburetor & Brake Cleaners and Polishers



Format = Part No., Year, Description, original Chevrolet Part Book Group No., Price and Unit Measure.

12T

Penetrating Oil



FREEALL

Penetrates rust, scale and corrosion to free stubborn parts and assemblies instantly. Loosens red & white lead, tar, grease, carbon & graphite deposits. Silicone free. 12 oz. can. (03.001-15)
\$6.00 EA

Cleaner-Carburetor



6505259

16 oz spray can (03.725-15)
\$3.00 EA

Cleaner-Brake



6129423

Superior cleaner. Many uses (spray can). (04.683-2)
\$3.00 EA

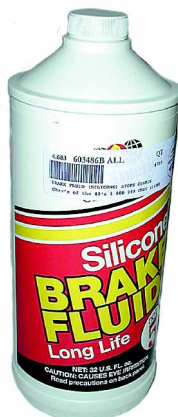
Brake Fluid



5450285B

DOT 4 (12 oz). (04.683-15)
\$3.00 EA

Brake Fluid



603486B

DOT 5, silicone. Less corrosion. (04.683-15)
\$18.00 QT

Gasket Sealer



1015BP

High temp silicone. Black (3.35 oz tube). (08.800-2)
\$6.00 EA

Adhesives & Sealers



986199A

3M Contact cement for rubber to metal. Bonds instantly. Industrial quality for gravel guards, running board rubber, etc. (08.800-15)
\$32.75 QT

Adhesives & Sealers



306105

Krazy Glue. Rubber to metal & rubber to rubber bonding. Splice window gaskets & sponge weather strip & more. (08.800-15)

\$3.00 EA



01608

3M plastic & emblem adhesive (5 oz. tube). (08.800-15)

\$11.50 EA



511114

Black weatherstrip cement, 5-oz tube. Superior product! (08.800-2)

\$7.50 EA



511113

Spray adhesive for bowdrill cloth. Best product available for all interior trim. (18 oz. spray can) (08.800-2)

\$15.00 EA



GL14

Windshield sealer. Seals leaks in new & old installation. Will not dry out. (08.800-15)

\$6.00 EA



GL16

Rubber repair kit. Repairs chipped running board rubber & other rubber materials. 2-part epoxy, 16 oz. (10.000-15)

\$34.25 EA

Providing part #'s speeds up your order, improves accuracy, and helps us maintain low prices.

See Illustration Index for core charge information and a list of abbreviations. For Body Model information, see 5T.



15T: Sound Deadener, Thermal Protection & Paints

Part No., Year, Description, original Chevrolet Part Book Group No., Price and Unit Measure.

Sound Deadener-Thermal Protection



DEADENER

The ultimate in noise reduction. Engineered specifically for the interior & exterior side of body panels. 200% decrease in noise & vibration than any .070in. asphalt material. Bonds to metal, fiberglass & wood. Easy to apply (spray gun, roller or brush), non-toxic & water based for easy clean up. Covers 30 sq. ft. (08.800-15)

\$78.00 GALLON



HEATSHIELD

Awesome heat reduction in a can! Lightweight, pliable and bonds to virtually any material! Made up of air filled glass beads held in suspension by a high temp latex acrylic binder. Two 15 mil applications yield a thermal value of R-24. Insulate & prevent corrosion with one product. Easy to apply, non-toxic. (08.800-15)

\$100.00 GALLON



SPRAYGUN

Spray gun. Siphon-feed spray gun for DEADENER & HEATSHIELD. (08.800-15)

\$100.00 EA

POR-15 Rust Preventive Paint



POR-15QT

1 quart. Rust-preventive coating applied directly over rusted or seasoned metal surfaces. Dries as rock hard, non-porous finish that won't chip, crack or peel. Prevents rust from recurring. Choose Black, Semi-Gloss Black, Gray or Silver. (08.800-15)

\$38.75 QT

POR-15QTSLV

Thinner. 1 quart. Use for easy cleanup or thinning of POR-15 paint. (08.800-15)

\$10.50 QT



Paint-Zero Rust



51112C

Satin black w/ rust inhibitors. Use on core supports, inner fender panels, etc (12 oz spray). Match to GM satin black. (08.800-15)

\$17.50 EA

Paint-Engine



986959S 29-52

Gray hi-temp (16 oz spray can). Color has been tested and is correct. (08.800-15)

\$14.00 EA



986970S 53-62

Blue (12-3/4 oz spray can) (08.800-15)

\$14.00 EA

Paint-Engine



986959A.....29-52

Gray. Reduce using Xylene (max of 15%). (08.800-0)

\$35.00 QT



986970A.....53-62

Blue (08.800-0)

\$35.00 QT



986970G.....37-46

Engine (olive) GMC (08.800-0)

\$35.00 QT



986970M47-59

Engine (red orange) GMC (08.800-0)

\$35.00 QT

VHT Hi-Temp Engine Enamel

986959R

Universal red (12 oz. spray can) (08.800-15)

\$7.25 EA

986959O

Chevy orange (12 oz. spray can) (08.800-15)

\$7.25 EA

986959FB

Flat black (12 oz. spray can) (08.800-15)

\$7.25 EA

986959B

Gloss black (12 oz. spray can) (08.800-15)

\$7.25 EA

986959SB

GM satin black (12 oz. spray can) (08.800-15)

\$7.25 EA

986959UA

Universal aluminum (12 oz. spray can) (08.800-15)

\$7.25 EA

Returns require a return authorization number, please call.

15T: Sound Deadener, Thermal Protection & Paints



Format = Part No., Year, Description, original Chevrolet Part Book Group No., Price and Unit Measure.

15T

VHT Hi-Temp Engine Enamel

986959BL
Chevrolet V8 blue (12 oz. spray can)
(08.800-15)
\$7.25 EA

Paint-Carburetor



12910
Carburetor renew,
bronze (5 oz. spray can)
(08.800-15)
\$15.50 EA



12911
Carburetor renew, silver
(5 oz. spray can)
(08.800-15)
\$15.50 EA

Paint-Cab Interior



985734P 37-39
Brown crinkle-for cab
interior (lacquer)
(16.080-0)
\$31.25 QT



604481P 40-46
Beige hammertone-for
cab interior (thin w/
enamel thinner)
(16.080-0)
\$49.75 QT

Paint-Cab Interior



3693291P 47-53
Semi flat brown, slight
metallic, for cab interior,
original, lacquer poly
(thin w/ enamel thinner)
(16.080-15)
\$39.00 QT



3700359P 47-54
Pulsar gray, for cab
interior, 47-54 Panel &
Suburban 54 deluxe
cab, interior lacquer
(16.080-15)
\$69.00 QT



985734S 54
Pearl beige for interior
of cab. (16.080-0)
\$49.75 QT

Paint-Battery Tray



12998
Corrosion resistant,
black (12 oz spay)
(08.800-15)
\$18.00 EA

Paint-Heater



604481P 42-46
Beige hammertone (thin
w/ enamel thinner).
(16.080-15)
\$49.75 QT



604481H 47-54
Silver hammertone (thin
w/ enamel thinner)
(16.080-15)
\$34.50 QT

Paint-Radio & Heater



985734P
Brown crinkle (lacquer)
(16.080-0)
\$31.25 QT

Paint-Exhaust



3657963C
Stainless steel
pigments. For exhaust
manifolds & pipes.
Gives a soft gray,
metallic finish.
(03.609-15)
\$13.00 PT



3657963FA
Very high temp, flat
aluminum for manifolds
& pipes. 12 oz spray
can. (03.609-15)
\$10.00 EA



3657963E
Clear, high temp (1200
degree) for exhaust etc,
12 oz spray can.
(03.609-15)
\$10.00 EA

Providing part #'s speeds up your order, improves accuracy, and helps us maintain low prices.

See Illustration Index for core charge information and a list of abbreviations. For Body Model information, see 5T.



15T: Sound Deadener, Thermal Protection & Paints

Part No., Year, Description, original Chevrolet Part Book Group No., Price and Unit Measure.

Paint-Cast Blast



3657963D
Cast blast high temp 1200 degree. Gray, fresh cast look for exhaust manifolds, etc. Rust preventative, 12 oz spray can. (03.609-15)
\$9.25 EA



3657963F
Gray cast blast, For non high heat applications. Gives fresh cast look. Rust preventative, 12 oz spray can (03.609-2)
\$7.25 EA

Paint-Inner Fender Panel

511112D
Flat black spray paint for use on core supports and inner fender panels. (08.800-15)
\$6.00 EA

Paint-Hub Caps & Trim



306567
Red, for hub caps & trim (special lettering enamel) 1/2 pint (08.800-3)
\$25.30 EA

Paint-Hub Caps & Trim

306553
Blue, for hub caps & trim (special lettering enamel). 1/2 pint. (08.800-2)
\$13.00 EA
306505
Black, for hub caps & trim (special lettering enamel) 1/2 pint (08.800-2)
\$13.00 EA

Returns require a return authorization number, please call.



Format = Part No., Year, Description, original Chevrolet Part Book Group No., Price and Unit Measure.

20T

Crate Engine Buyer's Guide

Have you been looking for a crate engine, but realized that with all of the different choices on the market you find yourself overwhelmed? If so, you are not alone! Here are some of the many details we offer to make sure you are getting the most out of your investment...

Entire rotating assembly is checked for tolerance and balanced within 2 grams. That's the weight of two \$1 bills! What that means to you is it guarantees a smooth running and durable performance engine with silky smooth power over the entire RPM range.

Besides all the meticulous blueprinting and balancing, EVERY SINGLE engine is put to the ultimate test on the dyno and tuned before it leaves Blueprint Engine's state of the art facility. That means your engine is ready to run, with real-world horsepower numbers. Timing and carburetor/fuel injection are set to ensure that trouble free start up you are looking for in a crate engine. And to top it all off we send you your engines' dyno sheet, so there is no guessing how much horsepower and torque your engine will make! Can the other guys give you that guarantee?



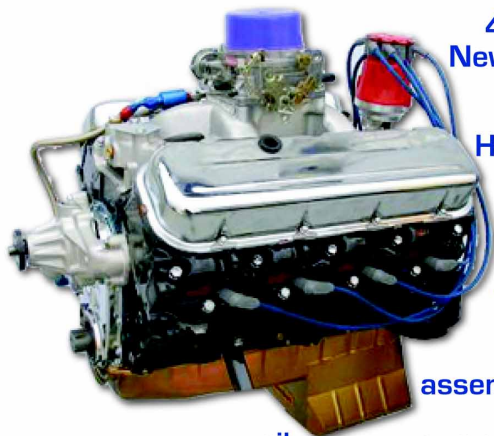
Hand selected blocks from hundreds of cores to ensure there is no core shift. Sure we could use new blocks, but with the strict quality demands our customers hold their engines up to, even new blocks would require some machine work. That way also, we can provide you an above average engine for a below average price.

Every Blueprint engine is built up to the intake level, tin included. If you decide you would like us to take care of all the work, you can order your engine complete.

What that means is we can include the fuel and ignition systems and even the pulley system, if you'd like. The choice is really up to you!

With a Blueprint Crate Engine, you are getting a 30 month, 50,000 mile warranty. Your warranty covers parts and labor for the full term, which means your warranty is as good on the last day as it was on the first! Also, if you have a problem with your engine you can take it to any shop. We won't force you to return to the installer, or a few select places. Rest assured anywhere you go, your warranty follows.

GM 496



oil pump, 2-pc. rear main seal, Clevite bearings and flat tappet hydraulic lifter camshaft, Heavy duty double roller timing set, Milodon cad plated oil pan, Professional Products harmonic balancer & more.

Carb and Fuel Injected engines include Edelbrock Water & Fuel Pumps, braided fuel line and AN connectors, spark plugs & wires

4 bolt mains, New SCAT cast crankshaft, Keith Black Hypereutectic flat top pistons, SCAT 4340 forged rods, Balanced rotating assembly. Melling high volume

IRON HEAD

GM cast iron oval port heads with screw-in studs and guide plates, 113cc chambers, 2.25" intake, 1.88" exhaust valves plus Edelbrock Performer RPM airgap intake manifold. 9.0 to 1 compression & new chrome valve covers.

480hp, Torque: 550 BP4960CT \$5,695
add Edelbrock 800cfm carb & Ignition . BP4960CTC \$7,495

ALUMINUM HEAD

AFR rectangular port heads. 305cc runners & 119cc chambers. Includes dual plane, satin finish intake manifold. 9.5 to 1 compression & new polished aluminum-valve covers.

595hp, Torque: 615 BP4961CT \$9,995
add Demon 850cfm carb & Ignition... BP4960CTC \$11,995



Every engine is Dyno tested and shipped with results. 30 month/50,000 mile warranty.

Providing part #'s speeds up your order, improves accuracy, and helps us maintain low prices.

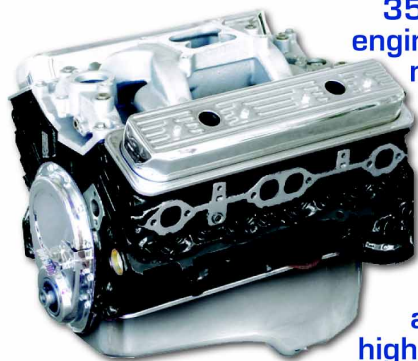
See Illustration Index for core charge information and a list of abbreviations. For Body Model information, see 5T.



20T: Crate Engines

Part No., Year, Description, original Chevrolet Part Book Group No., Price and Unit Measure.

GM 350



355 & 383 stroker engines include 4 bolt mains. New SCAT cast crankshaft. Keith Black Hypereutectic pistons. Chevy heavy beam rods. Balanced rotating assembly. Melling high volume oil pump. Clevite bearings and flat tappet hydraulic lifter camshaft.

Carb and Fuel Injected engines include Edelbrock Water & Fuel Pumps, braided fuel line and AN connectors, spark plugs & wires and MSD ignition.

383ci

VORTEC HEAD

New Cast iron heads with dual plane, satin finish intake manifold. 9.5 to 1 comp. & new chrome valve covers. Choose 1 or 2 piece rear main seal (add "1" to pt# for 1 piece).
405hp, Torque: 440 BP383OCT \$3,099*
add Edelbrock 750cfm carb & Ignition . BP383OCTC \$4,499

ALUMINUM HEAD

Includes dual plane, satin finish intake manifold. 9.5 to 1 compression & new aluminum valve covers.

395hp, Torque: 440 BP3836CT \$4,795
add Edelbrock 750cfm carb & Ignition . BP3836CTC \$6,395
425hp, Tq: 450, Multiport F.I. & Ignition. . BP3836CTF \$9,145

ALUMINUM HEAD - FORGED INTERNALS

Adds SCAT forged crank & PROBE forged pistons.

Includes dual plane, satin finish intake manifold. 9.5 to 1 compression & new aluminum valve covers.

400hp, Torque: 440 BP3837CT \$6,295
add Edelbrock 750cfm carb & Ignition . BP3837CTC \$7,895
440hp, Tq: 460, Multiport F.I. & Ignition. BP3837CTF \$10,645

355ci

VORTEC HEAD

New Cast iron heads with dual plane, satin finish intake manifold. 9.5 to 1 comp. & new chrome valve covers. Choose 1 or 2 piece rear main seal (add "1" to pt# for 1 piece).

385hp, Torque: 405 BP355OCT \$2,899**
add Edelbrock 600cfm carb & Ignition . BP355OCTC \$4,099

ALUMINUM HEAD

Includes dual plane, satin finish intake manifold. 9.5 to 1 compression & new aluminum valve covers.

360hp, Torque: 380 BP3555CT \$4,395
add Edelbrock 600cfm carb & Ignition . BP3555CTC \$5,995
390hp, Tq: 395, Multiport F.I. & Ignition. BP3555CTF \$8,865

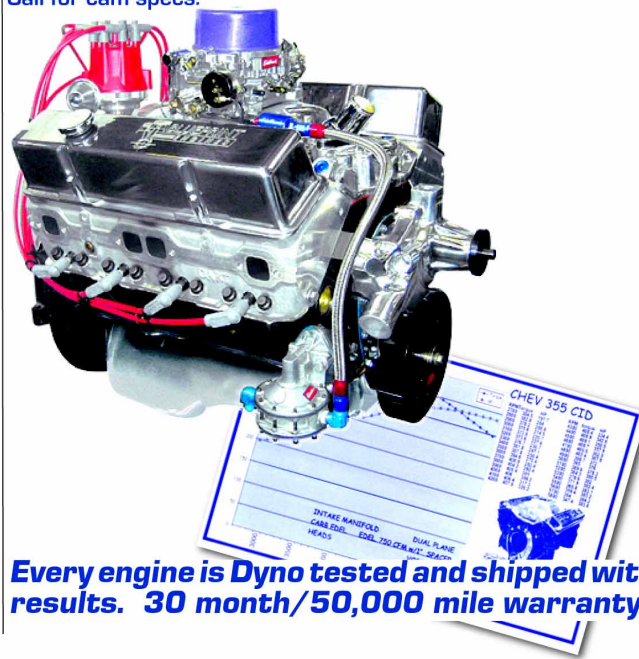
ALUMINUM HEAD - FORGED INTERNALS

Adds SCAT forged crank & PROBE forged pistons.

Includes dual plane, satin finish intake manifold. 9.5 to 1 compression & new aluminum valve covers.

385hp, Torque: 390 BP3556CT \$5,850
add Edelbrock 600cfm carb & Ignition . BP3556CTC \$7,495
415hp, Tq: 400, Multiport F.I. & Ignition. BP3556CTF \$10,199

Note: Engines on this page will not work if requiring EGR
* Requires external weight 400 style harmonic balancer
** Requires non-weighted balancer
Call for cam specs.



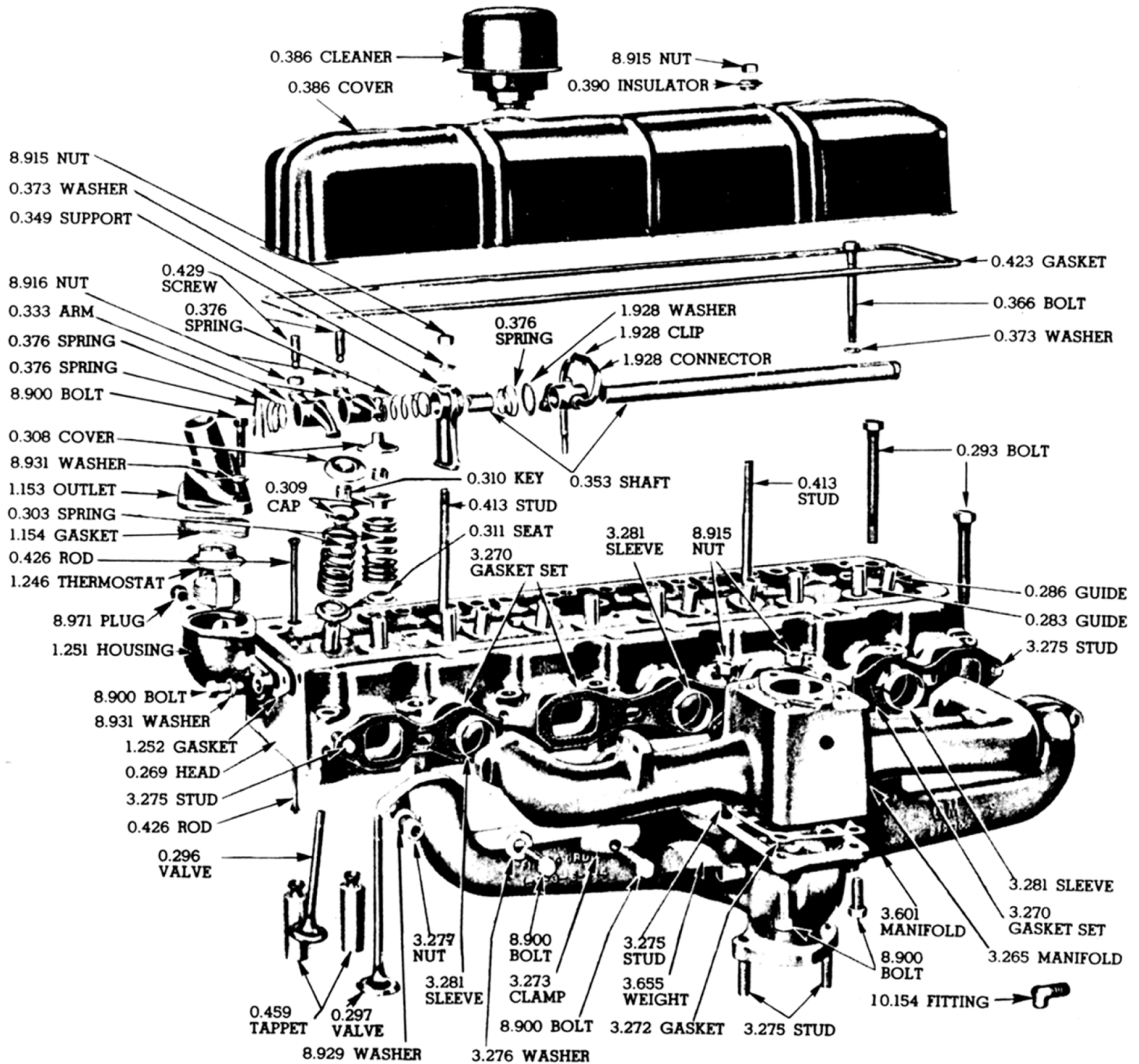
Every engine is Dyno tested and shipped with results. 30 month/50,000 mile warranty.

Returns require a return authorization number, please call.



Format = Part No., Year, Description, original Chevrolet Part Book Group No., Price and Unit Measure.

Engine Cylinder Head and Manifolds



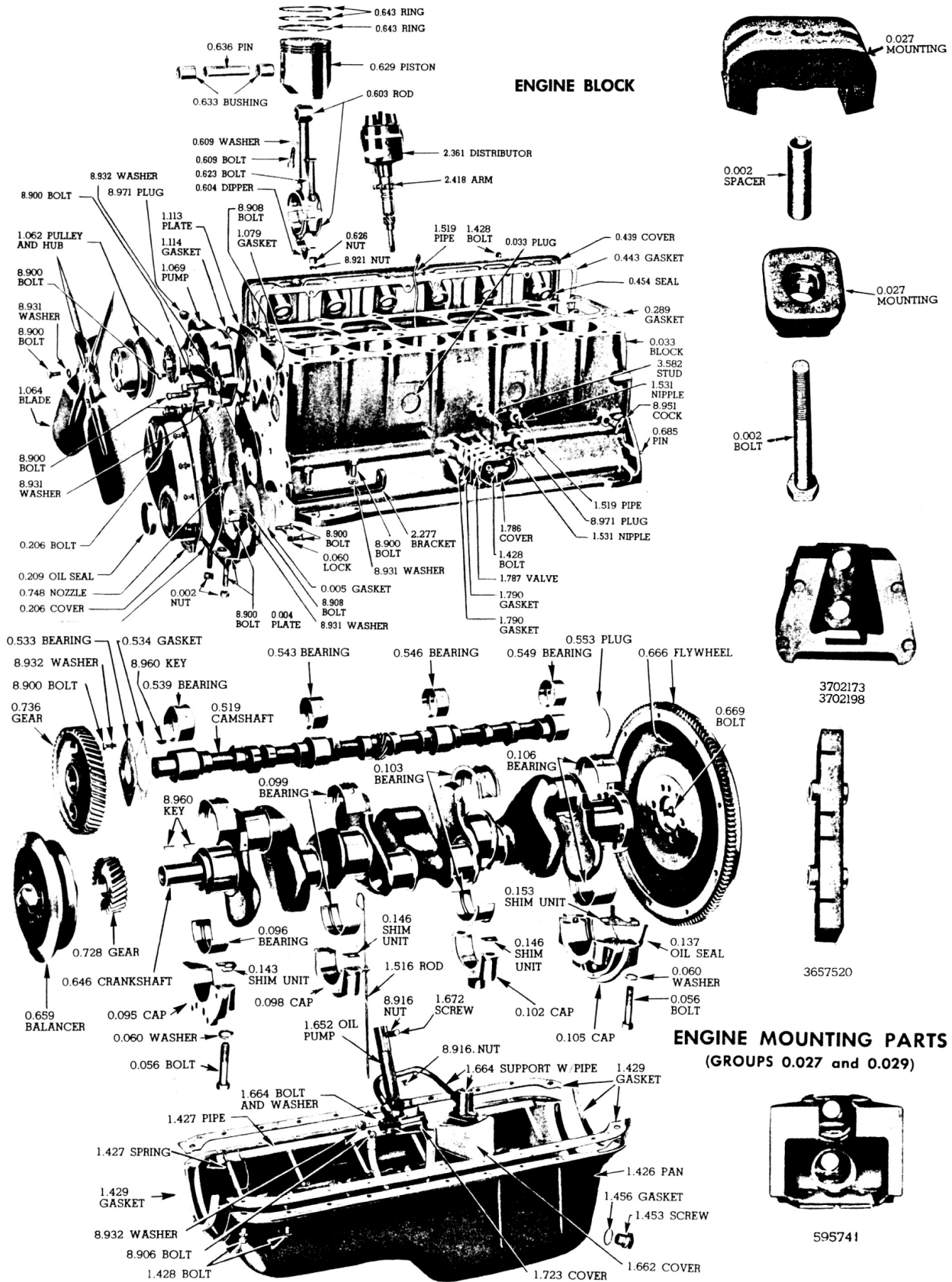
Providing part #'s speeds up your order, improves accuracy, and helps us maintain low prices.

See Illustration Index for core charge information and a list of abbreviations. For Body Model information, see 5T. 27



20T: Engine Kits

Part No., Year, Description, original Chevrolet Part Book Group No., Price and Unit Measure.



Returns require a return authorization number, please call.

20T: Engine Kits



Format = Part No., Year, Description, original Chevrolet Part Book Group No., Price and Unit Measure.

20T

Engine ID Chart

Model Year	216 CU Inch Numbers	Block Casting Numbers
1937	1 to 1187821	838101838710
1938	1187822 to 1915446 B1 to B10502	838710
1939	1915447 to 2697267 B10503 to B105461	838941
1940	2697268 to 3665902 B105462 to B221935	839400
1941	AA 1001 to AA	1163720
	AC 1001 to AC 19549	839400
1942	2AA, 2AC, BA.....	839770
1946	DA	839770
1947	EA	839770
1948	FA.....	3835253
1949	GA.....	3835253
1950	AHCA, AHCM, BHCA, BHCM, HAA, HAM, HAC, HAP, HBA, HBM, HCA, HCM, HCD, HCQ.....	3835497
1951	AJCA, AJCM, BJCA, BJCM, JAA, JAM, JAC, JAP, JBA, JBM, JCA, JCM, JCD, JCQ.....	3835497
1952	AKCA, AKCM, BKCA, CKCM, KAA, KAM, KAC, KAP, KBA, KBM, KCA, KCM, KCD, KCQ.....	3835849
1953	ALCC, ALCP, BLCC, BLCP, LAG, LAT, LAJ, LAV, LBA, LAM, LCA, LCM, LCC, LCP, LCD, LCH, LCU3835849	

Model Year	235 CU Inch Prefixes	Block Casting Numbers
1941	AG, AL	3660439
1942	BG, BL	839751
1946	BG, BL—1 st design	839751
1946	DDA, DDM, DEA, DEM—2 nd design.....	839751
1947	EDA, EDM, EEA, EEM.....	3835335
1948	FDA, FDM, FEA, FEM.....	3835309
1949	GDA, GDM, GEA, GEM	3835309
1950	HDA, HDM, HEA, HEM	3692703
1951	JDA, JDM, JEA, JEM	3692703
1952	KDA, KDM, KEA, KEM.....	3835692
1953	LDA, LDM, LEA, LEM, LAA.....	37019463701483
1954	T54 or F54 followed by: L, LA, M, MA, MB, N, P, Q, R, S, T, TA, U, UA, UB, X, XZ, XB, Y, YE, YG, Z, ZC, ZE, ZH.....	3701481
1954	Except 53 ST.....	3701481
1954	First series.....	3733949
1955	Through 4/1/56.....	3836233

Model Year	261 CU Inch Engine Block	Block Casting Numbers
1954-55	First series	37024363703414
1956	All	3836340
1957	All	3836340
1955-57	All	3836340
1958	All	3836340
1959	All	3759365
1960-62	All	3769923

Note: The 235 cu. in. engine can be distinguished from the 216 engine by the engine serial number prefix as follows:

- 1941.....AG or AL
- 1942.....BG or BL
- 1946.....BG or BL (First Design)
- 1946.....DDA, DDM, DEA, or DEM (Second Design)
- 1947.....EDA, EDM, EEA, or EEM
- 1948.....FDA, FDM, FEA, or FEM
- 1949.....GDA, GDM, GEA, or GEM
- 1950.....HDA, HDM, HEA, or HEM
- 1951.....JDA, JDM, JEA, or JEM
- 1952.....KDA, KDM, KEA, or KEM
- 1953.....LDA, LDM, LEA, or LEM

Providing part #'s speeds up your order, improves accuracy, and helps us maintain low prices.

See Illustration Index for core charge information and a list of abbreviations. For Body Model information, see 5T.



20T: Engine Kits

Part No., Year, Description, original Chevrolet Part Book Group No., Price and Unit Measure.

Engine Kit

When ordering: SPECIFY exact year and size of engine (216ci, 235ci or 261ci), HYDRAULIC or solid lifters, standard or exact oversize of rod, main bearings, pistons and rings. Also SPECIFY stick shift or powerglide.

Call for availability of pistons & bearings before boring block or having crank turned.

MEK1 Engine Kit

MEK1 contains all parts necessary to overhaul a complete short block assembly. Including: Rods machined for insert bearings, rod bearings, main bearings, pistons with pins, piston rings, new camshaft, lifters, cam bearings, timing gears, full gasket set, soft plugs, plastigauge, assembly lube, oil pump, bolt boots & block sealant lube. (1937-39 includes pushrods.) Call for pricing on the kits listed on this page.

MEK139	37-39	Includes pushrods	(00.001-15)
MEK140	40		(00.001-15)
MEK147	41-47		(00.001-15)
MEK153	48-53	Except Powerglide	(00.001-3)
MEK152	50-52	For Powerglide	(00.001-15)
MEK162	53-62	Except 53 stick	(00.001-15)

MEK2 Engine Kit

MEK2 contents are same as MEK1 except reground camshaft instead of new.

MEK239	37-39	Includes pushrods	(00.001-15)
MEK240	40		(00.001-15)
MEK247	41-47		(00.001-0)
MEK253	48-53	Except Powerglide	(00.001-15)
MEK252	50-52	For Powerglide	(00.001-15)
MEK262	53-62	Except 53 stick	(00.001-15)

EK Engine Kit

EK contents are same as MEK2 except w/ out pistons & converted rods.

EK39	37-39	Includes pushrods	(00.001-15)
EK47	40-47		(00.001-15)
EK53	48-53	Except Powerglide	(00.001-15)
EK52	50-52	For Powerglide	(00.001-0)
EK62	53-62	Except 53 stick	(00.001-0)
EK58	54-58	For solid lifter	(00.001-15)

RRK Re-ring Kit

RRK contains: Rod bearings, piston rings, full gasket set, plastigauge, assembly lube & bolt boots.

RRK39	37-39		(00.001-3)
RRK53	40-53	Except 53 Powerglide	(00.001-3)
RRK62	53-62	Except 53 stick	(00.001-2)

RRK3 (Re-ring Kit w/ Main Bearings)

RRK3 contents are same as RRK except main bearings are included.

RRK339	37-39		(00.001-4)
RRK347	40-47		(00.001-4)
RRK353	48-53	Except 53 Powerglide	(00.001-4)
RRK362	53-62	Except 53 stick	(00.001-15)

CLK (Cam & Lifter Kit)

CLK contains: Reground camshaft, lifters & timing cover gasket set.

CLK39	37-39	Solid lifter w/ pushrods	(00.001-15)
CLK53	40-53	Solid lifter exc 53 Powerglide	(00.001-15)
CLK52	50-52	Hydraulic lifter for Powerglide	(00.001-15)
CLK62	53-62	Hydraulic lifter exc 53 stick	(00.001-15)
CLK58	54-58	Solid lifter	(00.001-15)

CLK3 (Cam, Lifter Kit & Timing Gears)

CLK3 contents are the same as CLK except timing gears are included.

CLK339	37-39	Solid lifter w/ pushrods	(00.001-15)
CLK353	40-53	Solid lifter exc 53 Powerglide	(00.001-15)
CLK352	50-52	Hydraulic lifter Powerglide	(00.001-15)
CLK362	53-62	Hydraulic lifter exc 53 stick	(00.001-2)
CLK358	54-58	Solid lifter	(00.001-15)

PRK (Piston & Ring Kit)

PRK contains: Pistons with pins and piston rings.

PRK40	37-40	Domed piston	(00.001-0)
PRK53	41-53	216ci	(00.001-15)
PRK62	41-62	235ci (exc 53 Powerglide)	(00.001-15)
PRK61	54-62	261ci	(00.001-0)

Kits containing the following parts will have core charges of: Reground cams: \$35 ea., Rods: \$35 ea. Until we receive your cores!

Oversize shipping charges apply. Please call for rate.

Returns require a return authorization number, please call.

22T: Engine Components, Valve Covers, Rods, Bearings, Oil Pumps & Related



Format = Part No., Year, Description, original Chevrolet Part Book Group No., Price and Unit Measure.

Street Rod Parts

Engine Bolt Kit Stainless Steel



368253A.....37-53
Hex head (exc 53 powerglide) includes bolts for distributor, side cover, valve cover, timing cover, thermostat, oil pan, intake & exhaust, fuel pump & water pump, also includes lube. (00.386-15)

\$32.50 SET

3836614A.....53-54
Hex head for a 235ci engine. Includes bolts for distributor, side cover, valve cover, timing cover, thermostat, oil pan, intake & exhaust, fuel pump & water pump and lube. (00.386-15)

\$32.50 SET

3836614B.....55-62
Hex head for a 235/ 261ci engine. Includes bolts for distributor, side cover, valve cover, timing cover, thermostat, oil pan, intake & exhaust, fuel pump & water pump and lube. (00.386-15)

\$32.50 SET

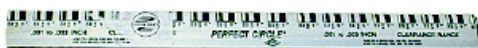
Restoration Parts

Note: Pilot bearing bushing see Section 140T.

Note: Engine electrical see Section 40T, 45T & 50T.

Note: Fuel pump & carburetor see Section 120T.

Plastigauge



609118P..... ALL
To check bearing clearance. (00.143-15)
\$2.00 EA

Main Bearings



384706.....37-39
.002 to .030 under. (00.099-0)

\$135.00 SET

384206.....40-47
Standard size to .075 under. (00.099-0)

\$135.00 SET

368847.....48-53
.002, .010, .020, .030 exc 53 Powerglide. (00.099-15)

\$130.00 SET

368855.....48-53
.040, .050, .060 exc 53 Powerglide. (00.099-15)

\$130.00 SET

370394.....53-62
Standard to .040 exc 53 stick. (00.099-2)

\$133.00 SET

Rod Bearings



370485.....37-53
Standard size to .060. exc 53 Powerglide. (00.616-0)

\$131.75 SET



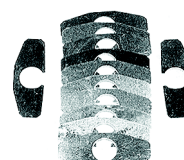
37048530..... 37-53
.030 Except Powerglide (00.616-15)

\$131.75 SET

370486.....53-62
Except 53 stick (00.616-0)

\$44.00 SET

Rod Bearing Shims



3692517.....29-53
.009 thick shims for rod bearings (00.619-0)
\$26.50 SET

Rod



602235A..... 37-53
Machined for insert bearing (\$35 core) (00.603-15)

\$52.00 EA

602235AA..... 37-53
Rebuilt with new babbitt (\$35 core) (00.603-15)

\$75.00 EA

602235N..... 37-47
Babbitt rods. Standard size only (NOS). (00.603-4)

\$45.00 EA

602235M..... 37-47
Machined for insert bearing (NOS) (00.603-2)

\$90.00 EA

Note: Price subject to bearing availability. Before grinding crank shaft, please contact us to be sure undersize bearings needed are available.

Note: SPECIFY exact model engine with rod casting number when possible. \$35 core charge refundable on rebuildable rod.

22T

Providing part #'s speeds up your order, improves accuracy, and helps us maintain low prices.

See Illustration Index for core charge information and a list of abbreviations. For Body Model information, see 5T.



22T: Engine Components, Valve Covers, Rods, Bearings, Oil Pumps & Related

Part No., Year, Description, original Chevrolet Part Book Group No., Price and Unit Measure.

Rod Bolt & Nut



107823..... **ALL**
Pal lock nuts for rod bolts (00.626-4)
\$4.50 SET

Rod Bolt Boots



986047B..... **ALL**
Protects crankshaft during assembly (08.800-2)
\$2.25 PR

Pistons



602806 **37-40**
Specify oversize (6 pcs) (00.629-0)
\$250.00 SET

605260 **41-53**
Fit 216ci (specify oversize). (6 pcs) (00.629-0)
\$186.00 SET

369398 **41-62**
W/ 235ci (specify oversize) (6 pcs). (00.629-15)
\$187.00 SET

3707460 **54-62**
W/ 261ci (specify oversize) (6 pcs) (00.629-15)
\$200.00 SET

Rings



608021 **37-53**
Fit 216ci (specify oversize) (00.643-0)
\$60.00 SET

370405 **41-53**
235ci exc 53 Powerglide (specify oversize) (00.643-15)
\$60.00 SET

370527 **53-54**
235ci exc 53 stick (specify oversize) (00.643-15)
\$60.00 SET

Rings

3720210..... **54-62**
261ci (specify oversize) (00.643-3)
\$60.00 SET

Cylinder Sleeves



3701164..... **37-53**
3/32in. wall, 216ci engine (00.033-2)
\$42.00 EA

3701164B **41-62**
3/32in. wall, 235ci engine (00.033-15)
\$42.00 EA

Valve Seats



3688065A **38-52**
Intake exc 50-52 235ci (00.296-4)
\$6.25 EA

3835318A **38-52**
Exhaust exc 50-52 235ci (00.297-3)
\$6.25 EA

3835519A **50-62**
Intake 235ci (00.296-4)
\$6.25 EA

3683569A **50-52**
Exhaust 235ci (00.297-2)
\$6.25 EA

3683569B **53-62**
Exhaust 235ci (00.297-2)
\$6.25 EA

Valve Guide



3688758..... **38-40**
Intake (00.283-15)
\$6.25 EA

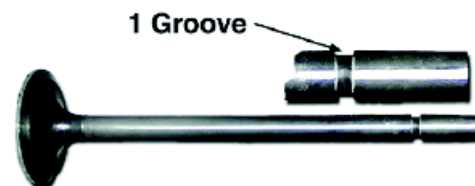
Valve Guide

3688759..... **38-40**
Exhaust (00.283-3)
\$6.25 EA

3708168..... **41-62**
Intake (00.283-3)
\$6.25 EA

3688761..... **41-62**
Exhaust (00.283-4)
\$6.25 EA

Valve

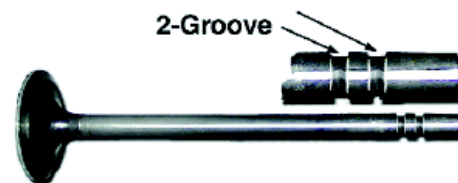


838437..... **35-40**
Intake (00.296-4)
\$15.50 EA

838717..... **35-40**
Exhaust (1 groove) (00.297-4)
\$15.50 EA

839504..... **41-49**
Intake (1 groove) (00.296-4)
\$15.50 EA

3835318..... **41-49**
Exhaust (1 groove) (00.297-4)
\$15.50 EA



3688065..... **41-53**
Intake (2 groove) exc 50 & later 235ci. (00.296-0)
\$15.50 EA

3835519..... **50-52**
Intake, 235ci only (1 groove). (00.296-3)
\$15.50 EA

3835910..... **53-62**
Intake, 235ci only (2 grooves). (00.296-15)
\$15.50 EA

3683569..... **50-62**
Exhaust, 235ci only (2 grooves). (00.297-4)
\$15.50 EA

Returns require a return authorization number, please call.

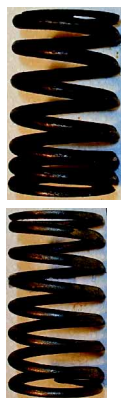
22T: Engine Components, Valve Covers, Rods, Bearings, Oil Pumps & Related



Format = Part No., Year, Description, original Chevrolet Part Book Group No., Price and Unit Measure.

22T

Valve Springs



3835626 28-52
(00.303-2)
\$3.00 EA

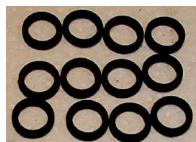
3704142 53-58
(00.303-3)
\$6.50 EA

Valve Spring Cap



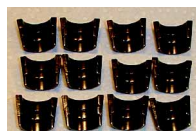
837624 35-47
Inlet (set of 6)
(00.309-4)
\$2.00 SET

Valve Seals



3835333 38-57
12 pcs (00.308-4)
\$8.00 SET

Valve Stem Locks



838029 34-57
Key (12 pcs) (00.310-4)
\$6.00 SET

Rocker Arm Shaft



839592 40-58
(00.353-2)
\$36.00 EA

Rocker Arm



837385B 34-54
Adjusting screw & nut.
(00.429-15)
\$5.00 EA

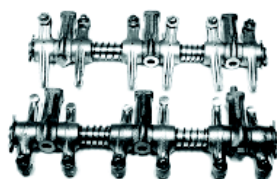
Rocker Arm



839459 41-53
Left Exhaust, exc 50-53 235ci. (00.333-4)
\$16.00 EA

939463 41-53
Left Intake, exc 50-53 235ci (00.333-4)
\$16.00 EA

Rocker Assembly



838244B 37-39
Fits 216ci (\$100 core) (00.352-15)
\$258.00 PR

609925
Fits 216ci (\$100 core) (00.352-15)
\$258.00 PR

609924 41-53
Fits 216ci (\$50 core) (00.352-15)
\$206.00 PR

3729191 50-58
235ci (\$50 core) (00.352-15)
\$206.00 PR

Lifters



838774 29-39
(00.459-15)
\$17.00 EA



839263 37-55
Solid, original 40-55
(37-39 must be used w/
pushrods #3835776)
(00.459-3)
\$11.00 EA



5230850 50-58
Hydraulic, w/
Powerglide (00.459-15)
\$14.00 EA

Pushrods



3835776 37-53
10-1/4". Fits 216ci, 37-39, use w/ lifter
#839263 (00.426-3)
\$8.00 EA

3836261 41-55
10-3/8". All 235ci exc Powerglide
(00.426-3)
\$7.00 EA

3835777 50-62
11-1/4". All 235ci w/ Powerglide (00.426-2)
\$7.25 EA

Camshaft



3836491 37-53
For solid lifters, new (00.519-15)
\$110.00 EA

3836491R 37-53
For solid lifters, reground (\$80 core)
(00.519-2)
\$80.00 EA

3836491RC 37-53
Reground to 53 Corvette specs, for solid
lifters (\$80 core) (00.519-15)
\$95.00 EA

3836485 50-53
For hydraulic lifters, new (00.519-15)
\$137.00 EA

3836485R 50-53
For hydraulic lifters, reground (\$100 core)
(00.519-2)
\$76.00 EA

3713919 54-55
For solid lifters, new, exc Powerglide &
261ci (for 261ci use part #3836484)
(00.519-15)
\$108.00 EA

3713919R 54-55
For solid lifters reground (\$40 core) exc
Powerglide & 261ci (for 261ci use part #
383684R) (00.519-15)
\$68.00 EA

3836483 54-62
For hydraulic lifters, new (00.519-15)
\$171.00 EA

Providing part #'s speeds up your order, improves accuracy, and helps us maintain low prices.

See Illustration Index for core charge information and a list of abbreviations. For Body Model information, see 5T.



22T: Engine Components, Valve Covers, Rods, Bearings, Oil Pumps & Related

Part No., Year, Description, original Chevrolet Part Book Group No., Price and Unit Measure.

Camshaft

3836483R **54-62**
For hydraulic lifters/reground (\$40 core)
(00.519-15)

\$68.00 EA

3836484 **54-58**
For solid lifters, new, 235ci, 261ci
(00.519-15)

\$144.50 EA

3836484R **54-62**
For solid lifters, reground, 235ci, 261ci (\$40 core)
(00.519-15)

\$68.00 EA

Camshaft Bearings



838846B **37-53**
(00.539-15)

\$45.00 SET

3836191 **54-58**
(00.539-0)

\$37.40 SET

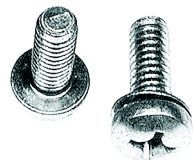
Camshaft Thrust Plate & Spacer



3702305 **37-57**
(00.533-2)

\$8.75 SET

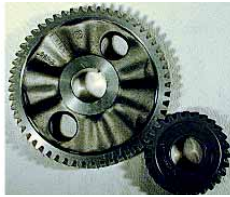
Camshaft Thrust Plate Screws



3702305A **37-57**
(00.533-4)

\$1.25 SET

Timing Gear



3835371B **37-62**
Crank & aluminum camshaft gear. Matched set (00.728-15)

\$61.75 SET

Stove Bolt



839301 **40-60**
W/ lock washer correct for timing cover, pushrod cover & oil pan (8 pcs) (01.428-4)

\$3.00 SET

Cylinder Head Bolts



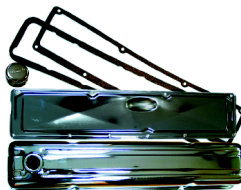
3837543 **34-62**
Long (00.293-2)

\$3.75 EA

3837544 **37-62**
Short (00.293-15)

\$3.50 EA

Valve & Rocker Cover Set



3836614S **37-62**
Chromed covers w/ breather cap and gaskets. Excellent finish. Comes with stainless screws. Fits 235ci. (00.386-15)

\$100.00 SET

Valve Cover-Chevy 6-Cylinder



3686784C **ALL**
Chrome 1937-53 Chevy 216 6-cyl Valve Cover - Unbaffled (-15)

\$38.25 EA



R9108 **ALL**
Chrome 1950-62 Chevy 235 6-cyl Side Plate - Unbaffled (-15)

\$27.50 EA



R9107 **ALL**
Chrome 1950-62 Chevy 235 6-cyl Valve Cover - Unbaffled (-15)

\$35.75 EA

Wayne Valve Cover



3686784W **37-62**
Finned aluminum cover. Superb reproduction w/ breather cap and stud kit. (00.386-0)

\$150.00 EA



838083B **37-62**
Studs, grommets & chrome acorn nuts for Wayne valve cover (00.413-15)

\$12.50 SET

Returns require a return authorization number, please call.

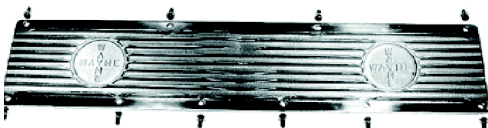
22T: Engine Components, Valve Covers, Rods, Bearings, Oil Pumps & Related



Format = Part No., Year, Description, original Chevrolet Part Book Group No., Price and Unit Measure.

22T

Wayne Push Rod Cover



3701541W **50-62**
Finned aluminum side cover. Superb reproduction, fits 235ci-261ci (00.439-0)
\$75.00 EA

Valve Cover-Grommets



838083 **34-53**
2 pcs (00.413-15)
\$2.00 PR

Valve Cover-Acorn Nut



131502 **29-53**
Stainless (08.915-4)
\$4.25 SET



131502P **29-53**
Polished stainless (08.915-3)
\$10.75 SET

Oil Fill Cap



3835665 **46-57**
Breather on rocker cover, replacement. (00.386-2)
\$13.25 EA



836450 **ALL**
Chrome, fits aluminum valve cover (breather cap) (01.516-15)
\$11.25 EA

Sleeves-(Metal)



837273 **39-53**
Intake to head 216ci. Exc 50-53 235ci (3 piece set) (03.281-15)
\$6.50 SET

Sleeves-(Metal)

3835506 **50-62**
Intake to head 235ci, 261ci (3 piece set) (03.281-15)
\$6.75 SET

Dampner-Balancer

605635 **ALL**
Recondition yours. 216ci, 235ci engines. (00.659-15)
\$199.50 EA

Woodruff Keys



106751 **ALL**
For harmonic balancer, crank and cam gears (3 pcs) (08.960-4)
\$3.00 SET

Engine Assembly Lube

Synthetic oils enable Royal Purple to make superior lubricants, but it is Royal Purple's advanced Synslide additive technology that gives Royal Purple's EP lubricants their amazing performance. Engine Performance magazine raves about this product.

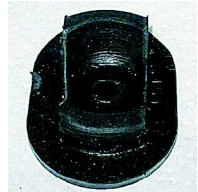


986047D **ALL**
Royal Purple. Synthetic. Performance Engine magazine raves about this product. 8 oz bottle. (08.800-15)
\$14.00 EA



986047 **ALL**
8 oz bottle. (08.800-15)
\$8.25 EA

Timing Hole Plug



836802A **ALL**
Rubber, rare (00.714-15)
\$5.50 EA

Soft Plug Set

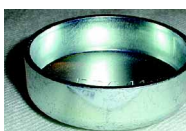


3835121 **37-54**
For complete plug kit you'll also need expansion plug #838127 (00.034-4)
\$7.00 SET

Expansion Plug



838127 **38-54**
Block, rear of camshaft 1-31/32in. (00.553-4)
\$1.25 EA



838128 **38-54**
Block, rear of camshaft 1-5/8in. (00.553-4)
\$1.50 EA

Oil Pan Plug



344690 **28-57**
1/2 in. w/ washer. Choose standard, single oversize, double oversize or triple oversize. (01.456-4)
\$2.00 EA

344690B **28-57**
W/ washer, 1/2in., single oversize (01.456-2)
\$2.00 EA

344690C **28-57**
W/ washer, 1/2in., double oversize (01.456-15)
\$2.00 EA

344690D **28-57**
W/ washer, 1/2in., triple oversize (01.456-3)
\$2.00 EA

Providing part #'s speeds up your order, improves accuracy, and helps us maintain low prices.

See Illustration Index for core charge information and a list of abbreviations. For Body Model information, see 5T.



22T: Engine Components, Valve Covers, Rods, Bearings, Oil Pumps & Related

Part No., Year, Description, original Chevrolet Part Book Group No., Price and Unit Measure.

Alignment Tool



38352226 **37-53**
Used to align oil dipper troughs in pan (\$400 refundable deposit upon return of tool) (01.427-4)
\$35.00 RENT

Oil Fill Cap



836446 **31-48**
Gasket. Exc 48 3/4T & larger (01.517-4)
\$4.00 EA

Oil Dip Stick Tube

3685702 **47-57**
Cut to length 8-7/64in. (01.516-4)
\$12.00 EA

Oil Pressure Line



609912 **36-53**
Rocker arm, exc Powerglide w/ 235ci (01.519-2)
\$11.75 EA



1399637B **37-54**
Engine to gauge (01.519-4)
\$10.50 EA

Oil Distributor Valve



839170 **40-53**
Exc 53 Powerglide (01.787-15)
\$28.00 EA



839173 **40-53**
Gasket (01.790-2)
\$1.25 EA

Oil Pickup-Grommet



3701563 **53-54**
Grommet, oil pickup tube to screen assembly (01.664-4)
\$1.50 EA

Oil Pump



838440S **37-39**
For 216ci engine (NOS). Includes pickup, screen & instructions. In original box. (01.652-15)
\$130.00 EA



838440 **37-39**
For 216ci engine (NOS) (01.652-15)
\$130.00 EA

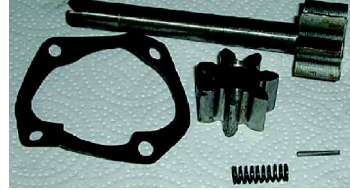


839157 **40-53**
Fits 216 & 235ci, exc 53 Powerglide (01.652-15)
\$82.75 EA

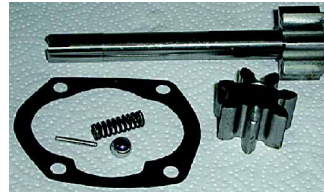


3702363 **53-54**
Fits 235ci, exc 53 stick (01.652-15)
\$75.75 EA

Oil Pump Rebuild Kit



839157A **40-53**
Rebuild kit, exc Powerglide (01.652-2)
\$28.75 EA



3702363A **53-54**
Rebuild kit, exc 53 stick (01.652-15)
\$40.25 EA

Oil Pump Drive Gear



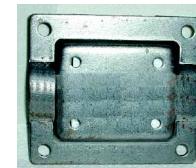
839164 **40-53**
Drive gear. Exc 53 Powerglide (NOS) (01.659-0)
\$5.00 EA

Bee Hive Oil Filter



5573017A **ALL**
Super reproduction, painted. Hard to find item (01.836-15)
\$266.00 EA

Bee Hive Oil Filter Bracket



5573017C **ALL**
Mount bracket, painted (01.836-0)
\$10.00 EA

Oil Filter Element



5572288C **ALL**
4-1/4in. o.d. x 5in. high, #P115 (01.836-2)
\$13.75 EA

Returns require a return authorization number, please call.

22T: Engine Components, Valve Covers, Rods, Bearings, Oil Pumps & Related



Format = Part No., Year, Description, original Chevrolet Part Book Group No., Price and Unit Measure.

22T

Oil Filter Element



5572288AALL
3-1/4in. o.d. x 4-1/8in.
high, #P203 (01.836-2)
\$13.75 EA



5572288DALL
4-1/4in. o.d. x 8in. high,
#P117 (01.836-15)
\$13.75 EA



5572288BALL
3-3/8in. o.d. x 5in. high,
#P209 (01.836-2)
\$13.75 EA

Oil Filter Hose



3702341 37-54
13in. (03.163-3)
\$18.50 EA



3654629 29-54
19in. (03.163-2)
\$18.00 EA

Odds & Ends

Please call for availability on all Odds & Ends parts; once part is sold, it may no longer be in stock.

838963N37-39
Body oil distributor valve (NOS) (01.785-0)
\$20.00 EA

36289729-36
Bushing- Piston Pin (NOS) (01~000-0)
\$2.00 PR

20537-53
Cambearings .030 (NOS) (00.539-0)
\$15.50 SET

370149053-61
Connecting Rod (fits 53 Pg & All 54-61)
(00.603-0)
\$75.00 EA

605487N29-32
Connecting rod bolts NOS (00.623-0)
\$23.00 EA

Odds & Ends

36371332
Connecting rod. Fits 1932 engine. NOS
(00.603-0)
\$75.00 EA

370188953
Connecting rod (fits all 53 & 53-55
Corvette) (00.603-0)
\$75.00 EA

383534437-53
Push rod cover. Fits 216ci (Used)
(01^000-0)
\$25.00 EA

83767735-36
Crankshaft Timing Gear (NOS) (0.728-0)
\$20.00 EA

373085957-58
Exhaust Valve, All exc Powerglide
(01*000-0)
\$4.00 EA

383602655
Exhaust Valves (Pass Exc P/g) (NOS)
(00.297-0)
\$10.00 EA

369537341-55
Exhaust Valve Rotor Assembly (00.309-0)
\$3.00 EA

83848337-53
Flywheel Shield Extensions (Odds & Ends)
(00.679-0)
\$15.00 EA

83922639-54
Gasket - oil pump screen cover (07.356-0)
\$2.00 EA

838774N29-39
Lifters (Solid) (NOS) (00*459-2)
\$22.00 EA

3847065N37-47
Main bearing-front intermediate (00.099-0)
\$10.00 EA

370155647-49
Oil Dipstick NOS (Comm & Utility).
(01*000-0)
\$15.00 EA

369072232-57
Oil nozzle at timing gear (00.748-0)
\$5.75 EA

603956A37-39
Oil Pan Pipe Assembly (NOS) (01*000-0)
\$85.00 EA

Odds & Ends

838458N 29-39
Oil Pickup cover(NOS) (Shelf Worn)
(01.656-0)
\$17.50 EA

3835365 48-50
Oil pump screen cover support assembly.
Note: when using this part it will be
necessary to peen back edges of tray to
provide clearance for oil pump suction
pipe. (01.664-0)
\$25.00 EA

838803 29-39
Oil Pump Screen (NOS) (01.656-0)
\$15.00 EA

604509 35
Oil pump NORS (7-11/16" overall length)
(02.108-0)
\$60.00 EA

955-INEX ALL
Oil Regulator Valve Silencing Cap
(0.303-0)
\$20.00 SET

3712747 40-52
Pipe & Cover Oil Pump (NOS) (01.664-0)
\$20.00 EA

60280660A 37-40
Piston .060in. (0.629-0)
\$45.00 EA

60280680A 37-40
Pistons .080in. (NOS) (00.629-0)
\$35.00 EA

608202 37-53
Rings for 216ci .020 (NOS) (00.643-0)
\$60.00 SET

60280680N 37-40
Pistons. 216ci Engine .080 over (NOS)
(00.629-0)
\$200.00 SET

60526010N 41-53
Pistons (NOS). Fits 216ci, .010 over.
(00.629-0)
\$100.00 EA

6028060N 37-40
Pistons. Fits 216ci standard bore (NOS).
(00.629-0)
\$41.75 EA

6052600N 41-53
Pistons. Fits 216ci, standard bore (NOS).
(00.629-0)
\$30.00 EA

Providing part #'s speeds up your order, improves accuracy, and helps us maintain low prices.

See Illustration Index for core charge information and a list of abbreviations. For Body Model information, see 5T.



22T: Engine Components, Valve Covers, Rods, Bearings, Oil Pumps & Related

Part No., Year, Description, original Chevrolet Part Book Group No., Price and Unit Measure.

Odds & Ends	
38355144	ALL Push rod cover used 235ci (10 bolt holes 5-21/32 x 27) (00.439-0) \$25.00 EA
3728993N	55-57 Rear main bearings (NOS) (0.96-0) \$15.00 PR
3731676	54-60 Piston ring set. NOS, fits 261ci engine, standard bore. (00.643-0) \$60.00 SET
838999	34-40 Rocker Arm- Exhaust (00.333-0) \$7.00 EA
838993	37-40 Rocker Arm- Left Intake (00.333-0) \$7.00 EA
837385U	34-54 Rocker arm & nut used (00.429-0) \$5.00 EA
3835528	40-53 Rocker Arm Oil Line Connector (NOS). (01.928-0) \$25.00 EA
838994	37-40 Rocker Arm- Right Intake (00.333-0) \$7.00 EA
836867	33-36 Rocker Arm Shaft Oil Connector (NOS) (01.928-0) \$12.00 EA
3835508	37-54 Rocker arm shaft spring (2-5/16" length) (00.376-0) \$8.00 EA
3835548	50 Rocker Arm. Exhaust, 235ci Engine (00.333-0) \$16.00 EA
3701304	53 Rocker Shaft Oil Line Connector (01~000-0) \$12.00 EA
838220	37-39 Rocker Shaft Sleeve 1/8in. Id On One End, 1/2in. Id On Other End (01.928-0) \$2.00 EA.
838246	37-53 Rocker shaft support with 216 (00.349-0) \$40.00 EA

Odds & Ends	
3836090	54-56 Rotator-Exhaust Valve, 1.5 Ton (00.309-0) \$3.00 EA
837656	35-36 Oil pan seal at front crankcase. NOS-shelf worn. (0.213-0) \$3.00 EA
3835246	37-53 Pushrod cover seal. Cork. Fits all 216ci (00.454-0) \$1.00 EA
602325	37-42 Shims for crankshaft front bearing (0.146-0) \$5.00 SET
609121	40-50 Shims for crankshaft rear bearing (0.153-0) \$5.00 EA
195	37-39 Small spring around pushrod, inside (-0) \$4.00 EA
839304	38-50 Spring Valve All Exc PG (NOS) (00.603-0) \$3.00 EA
839156	40-50 Spring-pump Screen Retaining (01.657-0) \$3.00 EA
837253	30-50 Spring-Valve on rocker shaft (NOS) (0.376-0) \$10.00 EA
3835520	50-53 Support, Rocker Arm Shaft, 235ci (00.349-0) \$10.00 EA
609533N	33-36 Timing Gear Cover (NOS) (00.206-0) \$65.00 EA
839104U	37-42 Valve cover. Needs to be repainted (Used). (00.386-0) \$50.00 EA
838336U	30-53 Valve Cover Studs (0.413-0) \$4.00 PR
3686784U	37-53 Valve cover (Used) (01^000-0) \$40.00 EA
838246	37-54 Valve rocker shaft retainer hair pin (00.376-0) \$5.00 EA

Odds & Ends	
837365	34-37 Valve Spring All exc dc (00.303-0) \$3.75 EA.
3836755	57 Valve spring cap cover V-8 (00.308-0) \$10.00 SET
3835392N	47-48 Valve Spring Cap (NORS) (00.309-0) \$2.50 EA
837264N	35-42 Valve spring cap (00.309-0) \$2.00 EA
839897	41-48 Valve Spring Cap-Exhaust (00.309-0) \$2.00 EA
362477	29-36 Wrist Pins, .003 O.S. (NOS) (01~000-0) \$6.00 SET

Returns require a return authorization number, please call.

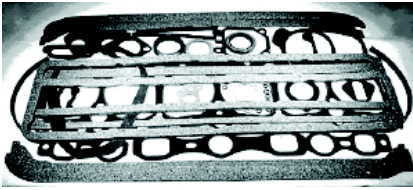
24T: Engine Gaskets & Seals



Format = Part No., Year, Description, original Chevrolet Part Book Group No., Price and Unit Measure.

24T

Gasket-Overhaul



- 3702872** **37-53**
Complete set. All (exc 53 P.G.) (00.010-15)
\$75.00 SET
- 3702872A** **50-52**
Complete set. Fits 235ci (00.010-15)
\$90.50 SET
- 3719628** **53-62**
Complete set. Fits 235ci (00.010-15)
\$74.00 SET
- 3836107B** **54-62**
Complete set. Fits 261ci (00.010-15)
\$80.00 SET

Gasket-Oil Pan



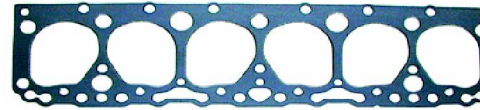
- 602373** **37-39**
(01.429-15)
\$10.50 SET
- 604338** **40-55**
(01.429-15)
\$9.75 SET

Gasket-Head

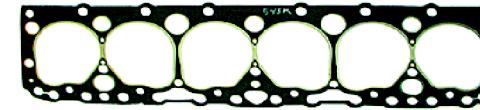


- 839541** **37-53**
216ci motor. (00.289-15)
\$28.50 EA
- 3835562** **50-52**
235ci motor (00.289-15)
\$34.25 EA

Gasket-Head



- 3701296** **53-62**
235ci motor (00.289-15)
\$26.75 EA



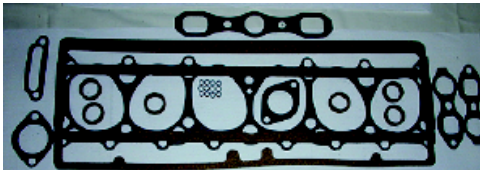
- 3836107** **54-62**
Fits 261ci (00.289-15)
\$26.50 EA

Gasket-Valve Cover



- 3694248** **37-53**
1/4in. thick (00.423-15)
\$9.50 EA
- 3696781** **54-62**
(00.423-15)
\$9.75 EA

Gasket-Valve Grind



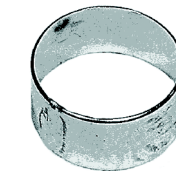
- 3691929** **37-53**
Exc 50-53 235ci (00.289-15)
\$50.00 SET
- 3707038** **50-53**
Fits 235ci, exc 53 Powerglide (00.289-15)
\$50.00 SET
- 3709428** **53-62**
Fits 235ci, exc 53 manual trans
(00.289-15)
\$57.00 SET
- 3709429** **54-57**
Fits 261ci (00.289-2)
\$37.00 SET

Seal-Front Timing Cover



- 3835946** **37-58**
(00.209-3)
\$9.75 EA

Dampner-Balancer



- 605203** **37-54**
Sleeve, repair seal
surface on crank
dampner (00.659-2)
\$8.00 EA

Seal-Rear Main



- 3835774** **40-58**
Original rope (2 pcs)
(00.137-15)
\$8.00 EA



- 3835774G** **40-58**
Like original rope.
Replaces original
asbestos type.
Graphite? (2 pcs)
(00.137-15)
\$19.25 EA



- 3835774R** **40-58**
Rubber (2 pcs)
(00.137-15)
\$19.25 SET

Gasket-Timing Cover



- 839048B** **37-62**
Complete set w/ seal (00.005-15)
\$18.50 SET

Providing part #'s speeds up your order, improves accuracy, and helps us maintain low prices.

See Illustration Index for core charge information and a list of abbreviations. For Body Model information, see 5T.



24T: Engine Gaskets & Seals

Part No., Year, Description, original Chevrolet Part Book Group No., Price and Unit Measure.

Gasket-Push Rod Cover



602336 **37-53**
Gasket w/ plug seals. Exc 50-53 235ci
(00.443-2)

\$14.25 SET

3835515 **50-62**
Fits 235ci & 261ci (00.443-15)

\$8.00 SET

Gasket (Intake-Exhaust Manifold)



602483A **37-53**
Intake & exhaust manifold. Fits 216ci
(3pcs) (03.270 -15)

\$11.00 SET

3707045 **50-58**
Intake & exhaust manifold. Fits 235ci &
261ci (3pcs) (03.270-15)

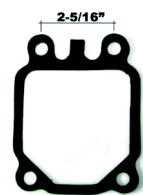
\$11.00 SET

Gasket-Manifold



838290 **37-53**
Rectangle between
manifolds. Fits 216ci
(03.272-15)

\$4.00 EA



3835572 **50-62**
Rectangle between
manifolds. Fits 235ci &
261ci (03.272-15)

\$4.00 EA

Gasket-Oil Fill Cap



836446 **31-48**
Gasket. Exc 48 3/4T &
larger (01.517-4)

\$4.00 EA

Gasket-Oil Distributor Valve



839173 **40-53**

Gasket (01.790-2)

\$1.25 EA

Gasket Sealer



1015BP **ALL**

High temp silicone.

Black (3.35 oz tube).

(08.800-2)

\$6.00 EA

Engine Assembly Lube



986047D **ALL**

Royal Purple. Synthetic.

Performance Engine

magazine raves about

this product. 8 oz bottle.

(08.800-15)

\$14.00 EA



986047 **ALL**

8 oz bottle. (08.800-15)

\$8.25 EA

Odds & Ends

Please call for availability on all Odds & Ends parts; once part is sold, it may no longer be in stock.

839541 **37-53**

Head gasket for 216ci motor (NOS).

(00.289-0)

\$20.00 EA

Returns require a return authorization number, please call.

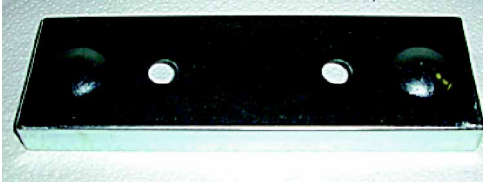
26T: Motor Mounts



Format = Part No., Year, Description, original Chevrolet Part Book Group No., Price and Unit Measure.

26T

Metal Cover



3656502 **37-54**
Front motor mount (00.029-15)
\$12.00 EA

Motor Mount-Front



3739939 **33-59**
Also fits 39-54 GMC. (00.027-2)
\$8.00 EA

Motor Mount-Rear



3702198 **37-53**
Chev & 39-53 GMC exc
48-53 (47 2nd design),
Chev 1/2T. (00.027-4)
\$26.25 EA



756700 **47-53**
1/2T (47-2nd design).
(00.027-2)
\$20.00 EA



3705444 **54**
Upper (00.027-4)
\$17.00 EA



3789949 **54**
Lower (00.027-4)
\$10.00 EA

Note: Transmission Mounts see Section 150T

Odds & Ends

Please call for availability on all Odds & Ends parts; once part is sold, it may no longer be in stock.

602790 **37-46**
Cushion-motor Mount Bracket Assy (Accy) Heater (00.027-0)
\$45.00 PR

3689112 **47-50**
Cushion-motor Mount Bracket with 2 Rear Brackets, 2 Hold Down Bolts, 2 Bolt Springs & Attaching Parts (Used To Replace Rubber Mountings for Heavy Duty Service) (00.027-0)
\$45.00 EA

602787 **37-50**
Rear bracket for cushioned motor mount (00.027-0)
\$15.00 EA

Email Sent: Friday, March 17, 2006 3:43 PM
To: chevsofthe40s.com
Subject: www.chevsofthe40s.com: Tissue Dispenser

name: David Cunha

message: Hi, My compliments to the girl I spoke with. After returning this item, she went and picked the best one she could find for my Show Truck. I think her name is Kristen? Just thought I'd write to give a pat on the back to a GREAT employee that you have. VERY SATISFIED. Thanks, Dave

Providing part #'s speeds up your order, improves accuracy, and helps us maintain low prices.

See Illustration Index for core charge information and a list of abbreviations. For Body Model information, see 5T. 41



30T: Radiators, Caps, Overflow Tanks, Water Pumps, Hoses, Electric Fans & Fan Belts

Part No., Year, Description, original Chevrolet Part Book Group No., Price and Unit Measure.

Street Rod Parts

Radiator (Aluminum)

Oversize shipping charges apply on radiators. Please call for rate.

The following aluminum radiators offer great value at an unbeatable price. They feature billet necks for durability, welded on mounting tabs and excellent finish. Polishing available on these radiators (inquire about pricing).

ALUMRAD 37-53..... 37-53
Fits 37-53. TYPE 1 size: 18in.W x 27in.H. Billet fill neck. Mounting brackets welded on. (01.219-15)
\$410.00 EA

ALUMRADT..... 37-53
Fits 37-53. TYPE 1 size: 18in.W x 27in.H. With internal trans cooler. Billet fill neck. Mounting brackets welded on. (01.219-15)
\$460.00 EA

ALUMRAD 46-54..... 46-54
Fits 46-54. TYPE 2 size: 20-1/4in.W x 24-1/2in.H. Billet fill neck. Mounting brackets welded on. (01.219-0)
\$410.00 EA

ALUMRADT..... 46-54
Fits 46-54. TYPE 2 size: 20-1/4in.W x 24-1/2in.H. With internal trans cooler. Billet fill neck. Mounting brackets welded on. (01.219-0)
\$460.00 EA

POLISHRAD ALL
Polish radiator. Add to radiator price. (01.219-0)
\$125.00 EA



ALUMRADFAN... ALL
Electric fan for PRC brand alum radiator. 16", 2360CFM. (01.219-15)
\$150.00 EA



ALUMRADSHROUD ALL
Aluminum fan shroud for PRC brand radiator. Polishing available for additional price. (01.219-15)
\$100.00 EA

Radiator (Aluminum)

POLISHSHROUD.....ALL
Polish shroud. Add to shroud price. (01.219-15)
\$40.00 EA

For components to add to your radiator such as Billet Cap, Overflow Tanks, Electric Fans and more, order our 2007 Street Rod Headquarters catalog or visit our website at www.StreetRodHQ.com

The following Aluminum radiators for street rods have 2 row cores (with 1in., 1.25in. or 1.5in.) wide tubes in core. **SPECIFY** year, size and location of outlets. We have 1937-38, 1939-40, 1941, 1942-46 & 1947-54.



3107891AALL
Griffin w/ 1in. tubes. (01.219-15)
\$555.00 EA

3109423AALL
Griffin w/ 1in. tubes & trans cooler. (01.219-15)
\$555.00 EA

3112131AALL
Griffin w/ 1.25in. tubes. (01.219-15)
\$588.50 EA

3114556AALL
Griffin w/ 1.25in. tubes & trans cooler. (01.219-15)
\$630.50 EA

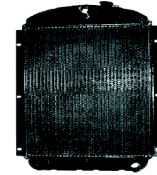
3116981AALL
Griffin w/ 1.50in. tubes. (01.219-15)
\$750.75 EA

3117891AALL
Griffin w/ 1.50in. tubes & trans cooler. (01.219-0)
\$780.25 EA

Radiator (Copper-Brass)

Oversize shipping charges apply. Please call for rate.

3118968A 47-54
V8 small block, 4 core w/ trans cooler (01.219-15)
\$546.50 EA



3118968..... 47-54
6 cylinder, 3 core. (01.219-15)
\$381.00 EA

Brace (V-Rod) Street Rod



59477337-38
Stainless Steel. (01.309-15)
\$88.00 EA

Restoration Parts

Radiator Cap



37068334-36
Seahorse gorgeous (accessory). (01.203-15)
\$170.00 EA



59449837-52
No pressure. (01.203-2)
\$6.00 EA



85050153-54
4 lb genuine AC. (01.203-15)
\$10.00 EA

Returns require a return authorization number, please call.

30T: Radiators, Caps, Overflow Tanks, Water Pumps, Hoses, Electric Fans & Fan Belts



Format = Part No., Year, Description, original Chevrolet Part Book Group No., Price and Unit Measure.

Radiator Cap



850795 55-57
7 lb genuine AC.
(01.203-15)
\$10.75 EA



850795R 53-57
7 lb replacement.
(01.203-3)
\$5.75 EA

Overflow Tank



985528 37-54
Accessory with hose,
mounting bracket and
screws (01.290-15)
\$150.00 EA

Note: For the correct decal see Section 550T.

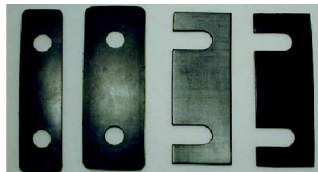
Hose Set



601607B..... 37-48
For accessory overflow tank w/ original GM
instruction sheet (01.240-4)
\$9.00 SET

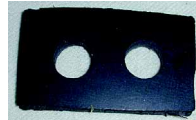
601607C..... 49-54
For accessory overflow tank w/ original GM
instruction sheet (01.240-4)
\$9.00 SET

Core Support Pads & Shims

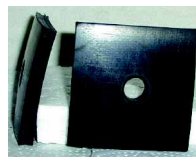


367314..... 39-46
Radiator core support mount. (01.270-4)
\$9.00 SET

Core Support Pads & Shims



3684763A 47-49
Radiator core support
mount. (01.270-3)
\$6.00 SET



3684763..... 50-54
Radiator core support
mount. (01.270-2)
\$4.50 PR

Core Support Bolt Kit



3676480..... 41-54
Radiator core support to
frame. (01.270-4)
\$2.50 SET

Radiator Petcock



134519..... 37-39
Replacement
(01.229-3)
\$4.00 EA

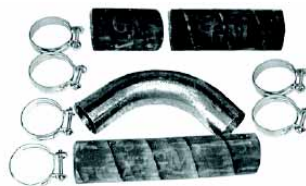


3113456..... 40-47
(01.229-2)
\$14.00 EA



3719518..... 48-57
(01.229-3)
\$4.00 EA

Radiator Hose Set



2782488 37-40
W/ metal elbow. (01.159-2)
\$32.75 SET

2782488A..... 41-46
W/ metal elbow. (01.159-2)
\$31.50 SET

Radiator Hose Set



3694277B 47-54
Molded hose with GM script with clamps.
(01.173-2)
\$23.50 SET

Upper Hose



364382P 37-46
GM script 6-3/4in. (01.130-4)
\$6.50 EA



3702348 47-54
Molded hose with GM script. (01.159-3)
\$8.00 EA

Metal Elbow



378248 35-40
In lower hose. (01.173-15)
\$16.00 EA

3656796 41-46
In lower hose. (01.173-15)
\$11.00 EA

30T

Providing part #'s speeds up your order, improves accuracy, and helps us maintain low prices.

See Illustration Index for core charge information and a list of abbreviations. For Body Model information, see 5T.



30T: Radiators, Caps, Overflow Tanks, Water Pumps, Hoses, Electric Fans & Fan Belts

Part No., Year, Description, original Chevrolet Part Book Group No., Price and Unit Measure.

Lower Hoses



3701363A..... **37-40**
GM script (2 pcs) (hoses are trim-to-fit).
(01.159-3)

\$9.50 SET

3701363B..... **41-46**
GM script (2 pcs). (01.159-4)

\$11.50 SET

Moulded Lower Hose



3692230 **41-46**
GM script, replaces metal elbow & 2 hoses.
(01.173-3)

\$15.75 EA

3694277 **47-54**
GM script, repro. (01.173-2)

\$13.00 EA

Radiator Hose Clamps



111616 **ALL**
Upper hose (original) (2 pcs). (01.166-4)

\$3.50 SET

111619 **ALL**
Lower hose (original) (2 pcs). (01.166-4)

\$3.50 SET

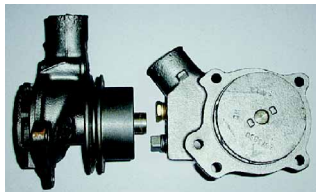
Water Pump Repair Kit



598308A..... **37-38**
(01.069-15)

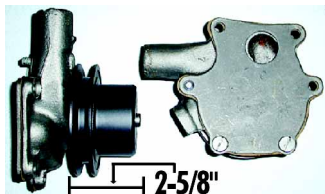
\$35.00 EA

Water Pump



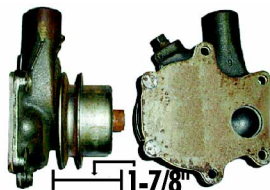
3741033..... **29-54**
W/ short (narrow) pulley & shaft. For use
on 55 & later 235ci & 261ci engines (\$35
core). (01.069-15)

\$85.00 EA



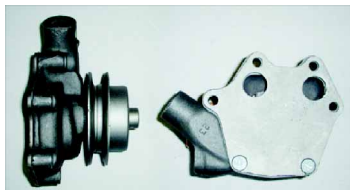
598308..... **37-38**
W/ gasket (\$60 core). (01.069-15)

\$85.00 EA



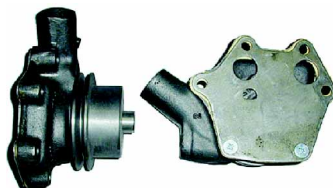
838903..... **39-40**
W/ gasket (\$60 core). (01.069-15)

\$85.00 EA



939467..... **41-52**
W/ gasket (\$30 core). (01.069-15)

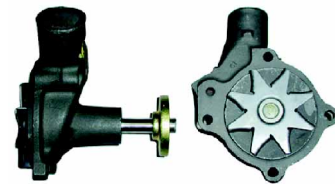
\$85.00 EA



3836804..... **53-54**
W/ gasket (narrow pulley). \$30.00 core
charge. (01.069-15)

\$85.00 EA

Water Pump



3774212..... **54-55**
Fits 261ci. (01.069-3)

\$85.00 EA

Pulley-Water Pump



3836804A..... **53-54**
(01.069-15)

\$20.50 EA

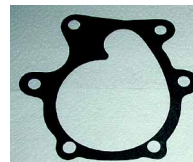
Backing Plate-Water Pump



838151 **37-40**
(01.113-2)

\$12.75 EA

Gasket-Backing Plate (Water Pump)



383150 **37-40**
(01.114-2)

\$3.00 EA

Gasket-Water Pump



839469 **41-54**
(01.114-2)

\$3.00 EA

Gasket-Water Pump To Block



838137 **37-40**
(01.079-2)

\$3.00 EA



3836048 **41-54**
(01.079-2)

\$3.00 EA

Returns require a return authorization number, please call.

30T: Radiators, Caps, Overflow Tanks, Water Pumps, Hoses, Electric Fans & Fan Belts



Format = Part No., Year, Description, original Chevrolet Part Book Group No., Price and Unit Measure.

Gasket-Water Pump To Block



3836162 **55-61**
For water pump w/ short pulley & shaft (part # 3741033 55 & later 235ci & 261ci engines) (01.069 -2)
\$3.00 EA

Gasket Sealer



1015BP **ALL**
High temp silicone. Black (3.35 oz tube). (08.800-2)
\$6.00 EA

Thermostat



3133598 **29-54**
160 degree. (01.246-4)
\$6.75 EA



838341 **37-57**
Thermostat housing gasket. Fits gooseneck. (01.154-15)
\$1.00 EA

Gasket-Head To Water Outlet



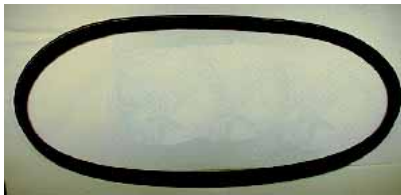
3838297 **37-62**
(01.252-15)
\$1.25 EA

Bushing



3837160 **38-55**
For temp gauge (01.150-2)
\$8.00 EA

Belt



3680776 **37-52**
For fan & generator, 5/8" wide. (01.066-3)
\$10.00 EA
3713313 **53-54**
For fan & generator, 1/2" wide. (01.066-15)
\$8.00 EA
2190650 **39-53**
For fan & generator. Fits GMC. (01.066-3)
\$9.00 EA
2304817 **54**
For fan & generator. Fits GMC. (01.066-2)
\$9.00 EA

Odds & Ends

Please call for availability on all Odds & Ends parts; once part is sold, it may no longer be in stock.

954417 **33-39**
Bearing Pinion Shaft Rear All Utility (13*000-0)
\$20.00 EA.
3653927 **40-47**
Bolt Axle Shaft 1/2-13x1-11/32 (13*000-0)
\$2.00 EA
838277U **37-54**
Fan Blade (Ga, Ha, Ka, Kh & 41-54 Pass and All Truck) Used (01.064-0)
\$20.00 EA
7161 **35-42**
Lock Ring Spacer, Ball Bearing Type (13-0)
\$7.50 EA
901305 **33-39**
Bearing Pinions Shaft NOS Rear Utility (13*000-0)
\$25.00 EA.
473636 **36-57**
Nut-Rear Wheel Bearing (36-53 Utility) (13*000-0)
\$10.00 EA
473636N **36-57**
Nut-Rear Wheel Bearing NOS (36-53 Utility) (13*000-0)
\$15.00 EA

Odds & Ends

595647 **37-39**
Shaft Bolt Lock Axle 3-1/8 I.D. (13*000-0)
\$15.00 EA
7320 **35-41**
Axle flange studs, oversize 1-1/2T (13*000-0)
\$1.00 EA
598308N **37-38**
Water Pump- (NOS) (\$35 Core Charge) (1.069-15)
\$120.00 EA

30T

Providing part #'s speeds up your order, improves accuracy, and helps us maintain low prices.

See Illustration Index for core charge information and a list of abbreviations. For Body Model information, see 5T.



35T: Air Conditioning, Heaters, Heater Switches, Heater Decals & Heater Paint

Part No., Year, Description, original Chevrolet Part Book Group No., Price and Unit Measure.

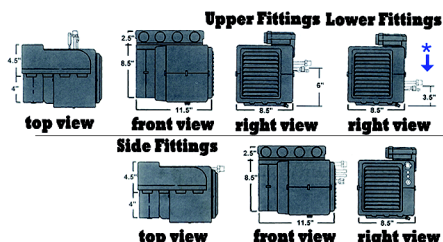
Street Rod Parts

Air Conditioning & Heating System

Systems come with everything you need to install Heat & Air Conditioning in your truck (other than the refrigerant). The Hurricane units are designed for minimal use of space to allow for stereos, glove boxes, wiper motors, etc. Choose unit with Upper, Lower or Side exit fittings (see dimensions below). System includes Sanden 508 Compressor (or equivalent), mounting brackets, Condenser (you'll need to measure your radiator), Receiver/ Drier, Binary Pressure Safety Switch, A/C & Heater Hose, Wire Harness, Clamps, 4" Vent Hose Kit, Control Panel w/ Knobs and more. Pick 4 vents to best suit your truck (some double vents count as 2). Optional items include Electronic Slide Controls (Vertical or Horizontal) in black or aluminum finish, Chrome Drier or Polished Compressor, all at a minimal cost.

Our condensers use flat tubes not round for increased efficiency.

The Heat & Defrost units for these systems mounts directly to your firewall. A/C & Heater lines pass through a custom rubber grommet that fits into the factory blower motor hole. This system includes deluxe plenum molded to fit the contour of the bottom of your dash with vents and switching built in. These systems are designed for easy installation with custom condenser mounting, aluminum lines and step-by-step instructions. Retains cowl vent and majority of glove box. Has floor Heat and De-Humidified Defrost.



AC1100C ALL
Complete System with Upper HVAC fittings and Electronic Controls. (09.779-15)
\$1,040.00 SET

Air Conditioning & Heating System

AC2100C.....ALL
Complete System with Side HVAC fittings and Electronic Controls. (09.779-15)
\$1,040.00 SET

AC3100C.....ALL
Complete System with Lower HVAC fittings and Electronic Controls. (09.779-15)
\$1,040.00 SET

A little tight on defroster space for your HVAC unit? Just let your sales rep know that you want the 90 degree defroster outlet option. And hey, we won't even charge you for it.

AC4100DC 47-54
Complete system. Mounts under dash in ABS plastic housing. Electronic Controls. (09.779-15)
\$1,070.00 SET

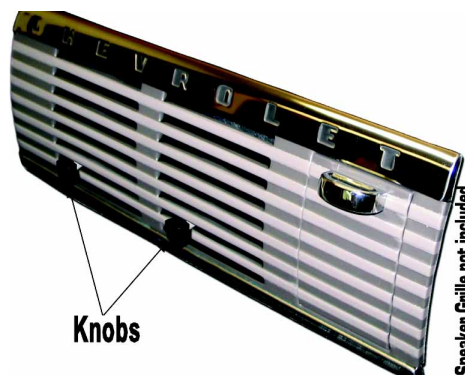


AC4000DC 47-54
Complete system w/ standard controls. (09.779-15)
\$998.50 SET

Switches & Center Vents hidden behind stock speaker grille. Order as a complete system or as interior only kit. Includes 2 additional vents (listed after A/C Systems).

Options: We offer Horizontal or Vertical Electronic Slide Controls. Brushed Aluminum or Black finish. You can also shine up your engine bay with a Polished Compressor and Chrome Drier (with polished clamp) or add a Trinary pressure switch. All for a very reasonable cost.

Air Conditioning & Heating System



AC4000GC 47-53
Complete system. Choose 2 additional vents. (09.779-15)
\$998.50 SET

AC4000GI 47-53
Interior only system. (A/C components forward of firewall: compressor, dryer, etc., not included.) (09.779-15)
\$495.00 SET

Choose the 4 vents that best fit your application: (VENT-3 and VENT-20 count as 2 vents)



VENT-1..... ALL
HVAC vent under dash, rectangular (2in. x 6-1/4in.) (09.779-15)
\$12.50 EA



VENT-3..... ALL
HVAC vents under dash, rectangular double vent (2in. x 11-1/2in.). Counts as 2. (09.779-15)
\$20.00 EA

Returns require a return authorization number, please call.

35T: Air Conditioning, Heaters, Heater Switches, Heater Decals & Heater Paint



Format = Part No., Year, Description, original Chevrolet Part Book Group No., Price and Unit Measure.

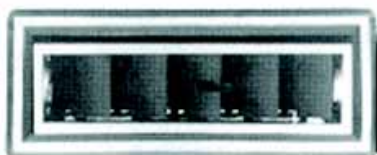
Air Conditioning & Heating System



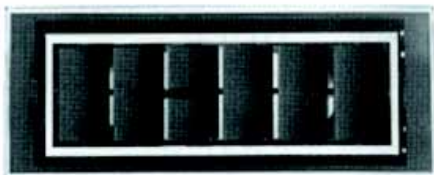
VENT-20 ALL
HVAC vents under dash, rectangular double vent (2in. x 10in.), Counts as 2. (09.779-15)
\$20.00 EA



VENT-5 ALL
HVAC vents in dash, rectangular (1-3/8in. x 4-3/4in.) (09.779-15)
\$10.00 EA

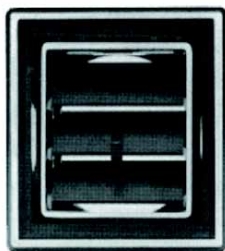


VENT-6 ALL
HVAC vents in dash, rectangular (1-3/8in. x 3-3/4in.) (09.779-15)
\$10.00 EA

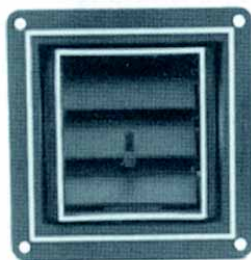


VENT-8 ALL
HVAC vents in dash, rectangular (2in. x 5-1/4in.) (09.779-15)
\$10.00 EA

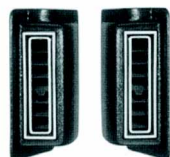
Air Conditioning & Heating System



VENT-7 ALL
HVAC vents in dash, rectangular (2-3/4in. x 2-1/2in.) (09.779-15)
\$10.00 EA



VENT-21 ALL
HVAC vents in dash, rectangular (3-1/2in. x 3-1/2in.) (09.779-15)
\$10.00 EA



VENT-14 ALL
HVAC vents kick panel louvers (pair) (09.779-15)
\$32.00 EA



VENT-2 ALL
HVAC vents under dash, round (3in. x 4-1/2in.) (09.779-15)
\$12.50 EA



VENT-10 ALL
HVAC vents under dash, round corner (09.779-15)
\$35.00 EA



VENT-9 ALL
HVAC vents in dash, round (2-1/4in. diameter) (09.779-15)
\$10.00 EA

Air Conditioning & Heating System-Upgrade



ACPNL-E ALL
Electronic controls. Smooth servo action. Available in Horizontal or Vertical cover plate and Brushed Aluminum or Black finish. (09.779-0)
\$75.00 EA



ACDRIERUP ALL
Chrome drier for air conditioning. With polished mounting bracket. 8in. L x 2-1/2in. dia. With sight glass. (09.779-0)
\$38.50 EA

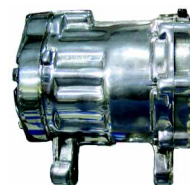


ACTRINARY ALL
In-line Trinary Pressure Switch. (09.779-2)
\$15.00 EA



ACDVENT ALL
Defroster vent. Replaces missing or worn vents. Plastic. (09.779-15)
\$16.00 EA

Air Conditioning Compressor



OAP21-6664P ALL
Polished Sanden for R-134A compressor. Vertical o-ring, 2-groove v-belt pulley-clutch. (09.170-15)
\$225.00 EA

OAP21-9285 ALL
Sanden for R-12 compressor. Vertical o-ring, 2-groove v-belt pulley-clutch. (09.170-15)
\$195.00 EA

OAP21-6664 ALL
Polished Sanden for R-134A compressor. Vertical o-ring, 2-groove v-belt pulley-clutch. (09.170-15)
\$195.00 EA

35T

Providing part #'s speeds up your order, improves accuracy, and helps us maintain low prices.

See Illustration Index for core charge information and a list of abbreviations. For Body Model information, see 5T.



35T: Air Conditioning, Heaters, Heater Switches, Heater Decals & Heater Paint

Part No., Year, Description, original Chevrolet Part Book Group No., Price and Unit Measure.

Air Conditioning Compressor

OAP21-9285P ALL
Polished Sanden for R-12 compressor. Vertical o-ring, 2-groove v-belt pulley-clutch. (09.170-15)

\$225.00 EA

OAP21-6629 ALL
Sanden for R-134A compressor. Vertical o-ring, serpentine belt pulley-clutch. (09.170-15)

\$195.00 EA

OAP21-6629P ALL
Polished for Sanden R-134A compressor. Vertical o-ring, serpentine belt pulley-clutch. (09.170-15)

\$225.00 EA

OAP21-9537 ALL
Sanden for R-12 compressor. Vertical o-ring, serpentine belt pulley-clutch. (09.170-15)

\$195.00 EA

OAP21-9537P ALL
Polished Sanden for R-12 compressor. Vertical o-ring, serpentine belt pulley-clutch. (09.170-15)

\$225.00 EA

Restoration Parts

Heater Switch



3108969 35-39
Super rare, shelf worn (NOS). (08.852-4)
\$42.50 EA



3112682B ALL
6v, rotary rheostat, clamps to dash bottom. (08.852-15)
\$17.00 EA



3112682C ALL
12v, rotary rheostat, clamps to dash bottom (08.852-15)
\$22.00 EA

Heater & Defroster Knob

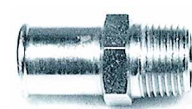


3129274C 47-53
Warmer, maroon. (08.861-15)
\$9.00 EA



3129274D 54
Warmer, black. (08.861-15)
\$9.00 EA

Heater Nipple



3106066 29-54
Connects heater hose to engine. (08.866-15)
\$7.25 EA

Heater & Defroster Shutoff Valve



985533 35-54
Replacement, screws into water pump. (08.870-15)
\$27.00 EA

Heater Control Valve



3128267 47-55
Rebuilt (\$50 core charge) (08.861-15)
\$90.00 EA

3128267D 47-55
Rebuild service using your core. (08.861-15)
\$110.00 EA

\$10 shipping & handling fee for rebuild service.

Heater Control Valve Rebuild Kit



3128267C 47-54
Rebuild kit, w/ instructions. (08.861-15)
\$12.75 EA

Defroster Duct Hose

3119156R ALL
1-1/2in. i.d. 36in. length. Plastic replacement (original was cloth covered, wound wire) (09.779-4)
\$24.00 EA

Defroster Duct Hose

3119719 ALL
1-3/4in. i.d. 36in. length. Cloth covered. (09.779-15)
\$24.00 EA

3125764 ALL
2in. i.d. 36in. length. Cloth covered. (09.779-15)
\$24.00 EA

Heater & Defroster Hose



3691292 ALL
Black, 5/8in. hose (08.846-3)
\$1.35 FT

Heater & Defroster Hose Clamps



432645 ALL
Fits 5/8in. hose. Original (4 pcs) (01.166-4)
\$4.25 SET

Heater Grommet



3691292A 47-54
Grommet for 5/8in. heater hose (thru firewall). (08.846-3)
\$5.00 PR

Heater Wiring Harness



3106048B 37-49
Heater & defroster (08.853-0)
\$46.50 EA

Heater Gasket



986248A 47-54
Gasket, deluxe heater set. (08.845-15)
\$12.00 EA

Returns require a return authorization number, please call.

35T: Air Conditioning, Heaters, Heater Switches, Heater Decals & Heater Paint



Format = Part No., Year, Description, original Chevrolet Part Book Group No., Price and Unit Measure.

Heater Core Rebuild

3115605R.....**37-54**
Rebuild your heater core (08.854-15)
\$375.00 EA

\$10 shipping & handling fee for rebuild service.

Paint-Heater



604481P **42-46**
Beige hammertone (thin w/ enamel thinner). (16.080-15)
\$49.75 QT



604481H **47-54**
Silver hammertone (thin w/ enamel thinner) (16.080-15)
\$34.50 QT

Heater Motor

5047688**47-52**
6v heavy duty exc airflow, stud center to center 2-1/2in., NOS. (08.855-0)
\$80.00 EA

5047730**47-54**
Heater Motor. 6v exc airflow (5-1/2in. x 3in. diameter), NOS. (08.855-2)
\$89.75 EA

Heater & Defroster Motor



5047531**37-54**
6v replacement (5in. x 3in. diameter) 1-3/8in. Shaft reversible. (08.855-15)
\$65.50 EA



5047849 **37-54**
12v replacement, (5in. x 3 in. diameter) 1-1/2in. shaft, reversible (08.855-15)
\$60.75 EA

Heater Box



986248..... **47-54**
Deluxe with recirculating fan. Exterior box only—no internal parts. (08.854-15)
\$148.50 EA

Decal Defroster



DEC06..... **47-55**
On/off defroster decal. (19.200-15)
\$2.00 EA

Decal Heater



DEC07..... **47-52**
Chevrolet round emblem. (19.200-15)
\$8.75 EA



DEC08..... **47-52**
GMC round emblem. (19.200-15)
\$8.75 EA



DEC09..... **53**
Fresh air round decal. (19.200-15)
\$2.50 EA



DEC10..... **53-54**
GMC round decal. (19.200-15)
\$2.50 EA



DEC16..... **54-55**
Fresh air round decal. (19.200-15)
\$2.50 EA

Decal Heater



DEC17 **53**
Recirculating round decal. (19.200-15)
\$3.50 EA



DEC18 **54-55**
Recirculating round decal. (19.200-15)
\$2.75 EA



DEC29 **49-51**
Decal-Harrison (19.200-2)
\$3.50 EA

Odds & Ends

Please call for availability on all Odds & Ends parts; once part is sold, it may no longer be in stock.

1997811 **38-48**
Defroster switch high low exc 42-46 COE (09.779-0)
\$40.00 EA

1997816 **47-49**
Heater switch used (08.852-0)
\$25.00 EA

04070 **41-48**
Switch, air , under dash (NOS) (09.779-0)
\$40.00 EA

35T

Providing part #'s speeds up your order, improves accuracy, and helps us maintain low prices.

See Illustration Index for core charge information and a list of abbreviations. For Body Model information, see 5T.

40T: Starters & Related

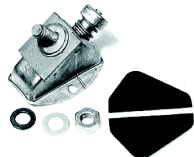


Format = Part No., Year, Description, original Chevrolet Part Book Group No., Price and Unit Measure.

Starter Switch



362941 29-37
Foot starter (NOS)
(02.100-4)
\$19.00 EA



820052 38-54
Foot starter (NOS)
(02.100-15)
\$19.00 EA



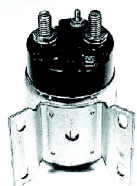
820052A 38-54
Foot starter (NORS)
(02.100-15)
\$17.25 EA

Starter Pedal Return Spring



3654152 37-54
Return spring.
(02.029-2)
\$5.50 EA

Starter Solenoid



1118135 54
Double Duty & 54-55
Hydromatic (02.100-0)
\$47.00 EA

Starter Solenoid Boot



1912448 49-59
Double duty model and
hydramatic (02.113-3)
\$9.75 EA

Starter Solenoid Repair Kit



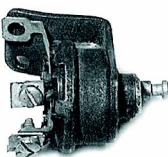
1118135A 49-54
Also fits 53-55 Corvette
(02.100-15)
\$12.50 EA

Insulator



1118135C 49-64
Molded, keeps solenoid
cool. (02.100-15)
\$16.00 EA

Reverse Polarity Switch



1889827 41-42
On starter, w/ 1in. x 1-
1/2in. base (NOS)
(02.117-4)
\$44.00 EA



1907122 46-48
On starter (NOS)
(02.117-4)
\$44.00 EA



1881929 41-48
Wiring harness for
reverse polarity switch.
(02.122-15)
\$18.00 EA

Engine Crank

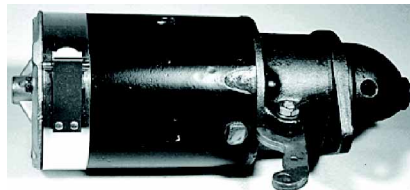


3661378 37-53
Manual start, hardened steel. Repro. If you
have the muscles!! (00.239-15)
\$60.00 EA



3681380 47-53
Starting crank support
bracket (07.025-15)
\$18.00 EA

Starter



1107108 38-54
Foot operated (\$35 core) (02.041-15)
\$116.00 EA

Starter



1913369 49-54
Uses solenoid (\$50 core). Fits Passenger
& DUBL-DUTI Trucks. (02.041-15)
\$116.00 EA

Starter Rebuild Service

1864489 37
Rebuild yours (02.041-15)
\$92.00 EA

Starter Rebuild Kit



1900558 37-54
W/ brushes, bushings
(18 pcs). (02.053-15)
\$24.00 KIT

Starter Brush Set



811553 25-54
(02.051-4)
\$5.00 SET

Starter Bushing



810620 29-37
Drive end (02.083-3)
\$2.75 EA



1839345 38-54
Drive end (02.083-2)
\$2.75 EA



810620A 38-54
Nondrive end
(02.083-3)
\$2.75 EA

40T

Providing part #'s speeds up your order, improves accuracy, and helps us maintain low prices.

See Illustration Index for core charge information and a list of abbreviations. For Body Model information, see 5T.



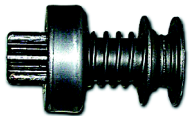
40T: Starters & Related

Format = Part No., Year, Description, original Chevrolet Part Book Group No., Price and Unit Measure.

Starter Drive



1859020.....**34-37**
(02.086-15)
\$82.00 EA



2873789.....**38-54**
(02.086-4)
\$30.00 EA

Starter Band



817114.....**29-54**
Covers openings on starter (02.070-15)
\$6.00 EA

Delco Remy Metal Tag



PLATE07.....**37**
Generator, starter & dist (19.400-3)
\$10.00 EA



PLATE05.....**38-54**
Generator, starter & dist (19.400-15)
\$6.00 EA

Odds & Ends

Please call for availability on all Odds & Ends parts; once part is sold, it may no longer be in stock.

813550.....**25-37**
Commutator end frame 25-37 Chevy. 26-29, 33-34 Pontiac (02.067-0)
\$15.00 EA

1907038.....**29-54**
Frame, Starting Motor Com. End (02.067-0)
\$15.00 EA

Odds & Ends

1885814U.....**49-50**
Starter motor lever used (02.108-0)
\$15.00 EA

1927200.....**55-57**
Starter Drive Assy. (Bendix) All (03.000-0)
\$20.00 EA

1119789.....**55-56**
Starter solenoid. 12V new item, never used. (02.100-0)
\$30.00 EA

Just a line or two to thank you all for your help in making my restoration as uneventful as possible. Couldn't have done as nice a job without you folks.

Thanks again

Paul & Kitty Jacques

Warwick RI

Returns require a return authorization number, please call.

45T: Alternators, Generators, Voltage Regulators, Batteries, Battery Trays & Battery Cables



Format = Part No., Year, Description, original Chevrolet Part Book Group No., Price and Unit Measure.

Street Rod Parts

Alternator

89502SALL
6v-60 amp, 7.5v internally regulated, single groove pulley, comes w/ DA plug, uses original wiring, new (02.275-0)
\$205.00 EA

89502CALL
6v-60 amp, 7.5v show chrome housing, 3/8in. 2 groove pulley, internally regulated, comes w/ D.A. plug, uses original wiring, new (02.275-0)
\$234.00 EA

90502SALL
12v-60 amp, 14v internally regulated, simple two wire hookup, replace any 12v generator, comes with D.A. plug, new (02.275-0)
\$205.00 EA

90502HOALL
12v-100 amp, 14v internally regulated, simple two wire hookup, replace any 12-volt generator, comes with D.A. plug new (02.275-15)
\$199.00 EA

D.A. Plug

89502 ALL
Connects 6v or 12v alternator to original wiring (02.275-15)
\$18.00 EA

Alternator Pulley

89502PALL
3/8in. 2 groove (02.274-15)
\$30.00 EA

90502WP 37-52
For 37-52 w/ 1/2in. belt (02.274-15)
\$30.00 EA

Mount Bracket

839446B.....37-55
Universal alternator bracket. (02.277-15)
\$75.00 EA

839446C.....37-55
Alternator bracket (12v or 6v alt. 37-52 requires 53-54 water pump & 53-up crank pulley). (02.277-0)
\$75.00 EA

Battery Disconnect

20019AALL
Switch. Effortless way of disconnecting negative battery post terminal (02.345-2)
\$8.00 EA

20019BALL
Switch. Effortless way of disconnecting negative battery bolt-on terminal (02.345-15)
\$15.00 EA

Battery Tender Plus

1.25 amp, Charges a battery and maintains it. Automatically switches from full charge to floating charge mode. Reverse Polarity Protection.



BT06V ALL
6 Volt Charger (02.332-15)
\$60.00 EA

BT12V ALL
12 Volt Charger (02.332-15)
\$60.00 EA

Battery Minder

1.33 max amp. Charger/ maintainer/ conditioner charges without overcharging. No sulphate build-up.



BM12V..... ALL
12 Volt Charger (02.332-15)
\$50.00 EA

BM06V..... ALL
6 Volt Charger (02.332-15)
\$50.00 EA

Restoration Parts

Delco Remy Metal Tag



PLATE07 37
Generator, starter & dist (19.400-3)
\$10.00 EA

45T

Providing part #'s speeds up your order, improves accuracy, and helps us maintain low prices.

See Illustration Index for core charge information and a list of abbreviations. For Body Model information, see 5T. 53



45T: Alternators, Generators, Voltage Regulators, Batteries, Battery Trays & Battery Cables

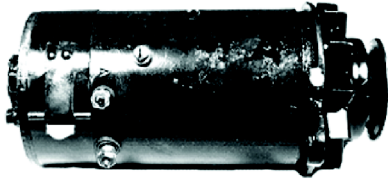
Format = Part No., Year, Description, original Chevrolet Part Book Group No., Price and Unit Measure.

Delco Remy Metal Tag

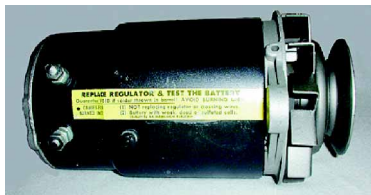


PLATE05..... **38-54**
Generator, starter & dist (19.400-15)
\$6.00 EA

Generator



1102744 **40-52**
10-1/2in. long, 6v (\$75 core) (02.275-15)
\$95.00 EA



1100024 **52-54**
9-1/2in. long, 6v (\$75 core) (02.275-15)
\$95.00 EA

Generator Rebuild Service

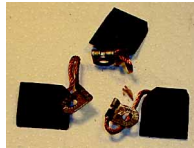
1100502 **29-39**
Rebuild service for your generator
(02.275-15)
\$95.00 EA

Generator Rebuild Kit



1901243 **40-54**
W/ brushes, bearings (41 pcs) (02.286-15)
\$29.00 KIT

Generator Brush Set



1857963 **37-39**
(02.285-15)
\$7.75 SET



1878209 **40-54**
(02.285-15)
\$3.75 SET

Generator Bearing

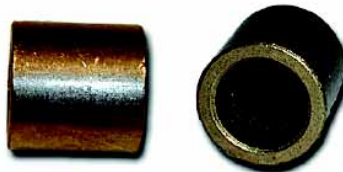


954378 **29-57**
Pulley end (02.306-3)
\$7.00 EA



954685 **53-57**
Commutator end
(02.298-0)
\$14.00 EA

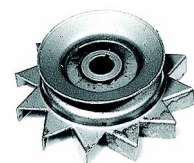
Generator Bushing



812823..... **29-48**
Commutator end (02.298-3)
\$3.50 EA

812824..... **49-52**
Commutator end (02.298-4)
\$2.50 EA

Generator Pulley



597667 **35-52**
(02.274-3)
\$17.00 EA

Generator Oil Fill Cover



816341 **29-54**
(02.305-3)
\$3.00 EA

Generator Band



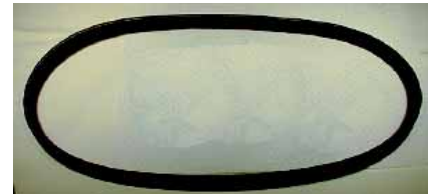
816340..... **29-52**
Covers opening in generator (02.299-15)
\$10.50 EA

Generator Bolt & Nut



3682642B..... **37-54**
Set (generator to motor)
(02.277-15)
\$5.00 SET

Belt



3680776..... **37-52**
For fan & generator (01.066-3)
\$10.00 EA

2190650..... **39-53**
For fan & generator. Fits GMC. (01.066-3)
\$9.00 EA

3713313..... **53-54**
For fan & generator (01.066-15)
\$8.00 EA

2304817..... **54**
For fan & generator. Fits GMC. (01.066-2)
\$9.00 EA

Voltage (Cut Out)



1867781 **29-39**
Exc COE (02.319-4)
\$75.00 EA

Voltage Regulator



1118309 **38-39**
NOS (02.500-15)
\$160.00 EA

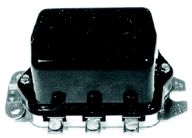
Returns require a return authorization number, please call.

45T: Alternators, Generators, Voltage Regulators, Batteries, Battery Trays & Battery Cables



Format = Part No., Year, Description, original Chevrolet Part Book Group No., Price and Unit Measure.

Voltage Regulator



1118301A 40-52
(02.500-15)
\$60.00 EA

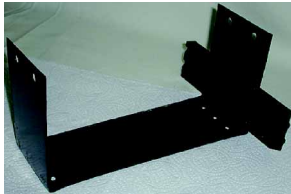


1118301 40-52
Genuine Delco w/ script
(02.500-15)
\$89.50 EA



1118331 53-54
(02.500-15)
\$60.00 EA

Battery Tray



594062 37-46
Metal tray only. (02.333-15)
\$25.00 EA

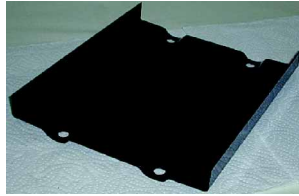


594062A 37-46
Metal tray w/ attaching brackets.
(02.333-15)
\$44.50 EA



3683559 47-54
Complete with sides and studs.
(02.333-15)
\$51.00 EA

Battery Tray



3683563 47-54
Base only. (02.333-15)
\$14.00 EA

Battery Tray Paint

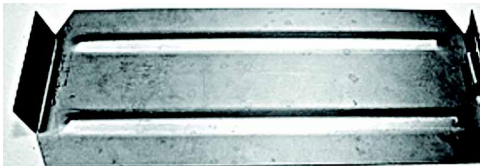


12998 ALL
Corrosion resistant,
black (12 oz spay)
(08.800-15)
\$18.00 EA

Battery Cover



354120 29-38
Inspection cover in floor. (16.547-3)
\$16.00 EA

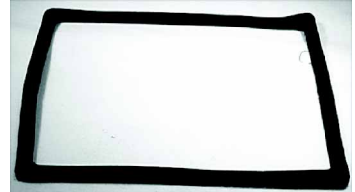


3652966 39-46
Inspection cover in floor. (16.547-3)
\$28.00 EA



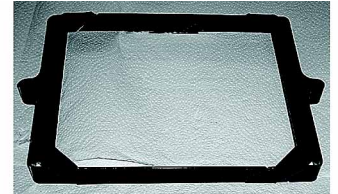
3683383 47-54
Inspection cover. Mounts in floor.
(16.547-15)
\$60.00 EA

Battery Cover Gasket



3683383A 47-54
Battery inspection cover. (16.547-3)
\$7.75 EA

Battery Hold Down



3653224 47-54
(02.335-15)
\$16.25 EA

Battery Mat



3686708B ALL
Anti-corrosion protect your tray (02.333-3)
\$6.50 EA

Ground Strap



529404 29-54
13in. GM script (NOS). (02.341-2)
\$25.00 EA
529404A 29-54
13in. replacement. (02.341-15)
\$11.50 EA
602387 47-54
Engine to frame. (09.650-15)
\$12.00 EA

45T

Providing part #'s speeds up your order, improves accuracy, and helps us maintain low prices.

See Illustration Index for core charge information and a list of abbreviations. For Body Model information, see 5T.



45T: Alternators, Generators, Voltage Regulators, Batteries, Battery Trays & Battery Cables

Format = Part No., Year, Description, original Chevrolet Part Book Group No., Price and Unit Measure.

Positive Cable



1854073 **29-46**
Fabric covered 25-1/4in. (02.342-15)

\$17.75 EA

5288946 **47-54**
Fabric covered 39-1/2in. (02.342-15)

\$23.00 EA

Odds & Ends

Please call for availability on all Odds & Ends parts; once part is sold, it may no longer be in stock.

940 **52-54**
Battery Filler Cap Accessory. Save A Battery (02.332-0)

\$35.00 SET

1910404 **37-52**
Frame generator drive end (02.305-0)

\$15.00 EA

00991 **57**
Generator 12 volt rebuilt (03.000-15)

\$75.00 EA

3703618U **53-54**
Generator Bracket 53-54 Pass, 53-55
Comm Use with 1100018 6 Volt (02.277-0)

\$15.00 EA

3835672 **52**
Generator Bracket. 6-1/8in. overall length.
Fits all 11000B small generators (02.277-0)

\$15.00 EA

3704711U **41-52**
Generator bracket (02.277-0)

\$15.00 EA

839447 **41-54**
Generator bracket ((Used)) (02.317-0)

\$15.00 EA

602253 **36-51**
Pulley on engine for low speed driving.
Keeps motor cool at low speed. (02.274-0)

\$25.00 EA

118301R **40-52**
Rebuilt voltage regulator (02.500-0)

\$75.00 EA

Odds & Ends

1118835 **52-55**
Voltage Regulator-rebuilt-6v-50amp
(13.500-0)
\$45.00 EA



Dear folks at Chevs of the 40's:
The photo is of a 10 year labor of love, finally finished, my 1937 1 1/2 ton. I couldn't have done it without you - thanks much for all the fine parts and, more important, thanks for all the advice. Now it's on to the next project - a 1937 GMC 1 1/2 ton with a wooden bottom-dump grain body. Thanks again. Mike Van Ryzin.

Returns require a return authorization number, please call.

50T: Ignition Systems, Ignition Switches, Vacuum Advances & Distributors



Format = Part No., Year, Description, original Chevrolet Part Book Group No., Price and Unit Measure.

Street Rod Parts

Ignition System, Electronic - Pertronix

Solid state electronic ignition system. Never change your points again! Will fit entirely inside the distributor (only fits part #1112362. Stamped inside the distributor.) Simple and easy to install.



1112362E6.....**41-53**
6v (02.384-15)

\$135.00 SET

1112362E12.....**41-53**
12v (02.384-15)

\$125.00 SET



1112388E6 **54-62**
6v. (02.384-15)

\$105.00 EA



1112388E12 ... **54-62**
12v. (02.384-15)

\$115.00 EA

Ignition Coil - Pertronix

PERTRONIX Flame Thrower 40,000 Volt Coil • Oil filled for better cooling and voltage insulation • Maximize energy and reliability over the full RPM range • 40,000 available volts • Enables larger plug gaps for greater fuel efficiency, more power • Delivers an average of 15% more spark energy and voltage • Legal in all 50 states and Canada • Fits existing brackets • Made in U.S.A.

Ignition Coil - Pertronix 6 Volt



PER40001.....**ALL**
Chrome. 1.5 Ohm primary resistance. (02.384-15)
\$40.00 EA

Ignition Coil - Pertronix 6 Volt



PER40011.....**ALL**
Black. 1.5 Ohm primary resistance. (02.384-15)
\$35.00 EA

Ignition Coil - Pertronix 12 Volt



PER40501.....**ALL**
Chrome. 3.0 Ohm primary resistance. (02.384-15)
\$40.00 EA



PER40511.....**ALL**
Black. 3.0 Ohm primary resistance. (02.384-15)
\$35.00 EA

Ignition Coil

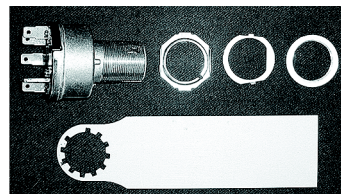


1115091.....**47-59**

12v and replacement for 6v systems. (02.170-2)

\$25.75 EA

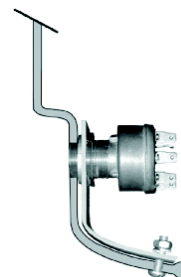
Ignition Switch



1116452A.....**ALL**

Are you using a fork lift ignition switch? Use our flush mount switch w/ mounting bracket. Use lock cylinder #1458180 or #3716725 with original keys. (02.188-15)
\$28.50 SET

Ignition Switch Mounting Plate



3688155.....**ALL**
Universal mounting plate conforms to your dash to mount your switch (cylinder not included). (02.192-3)
\$6.00 EA

Ignition Lock



1458180.....**35-57**
Cylinder & non-GM keys. Exc 48-57 Passenger. (02.188-4)
\$13.00 EA



3716725.....**47-48**
Cylinder & keys (non GM). (02.188-4)
\$18.00 EA

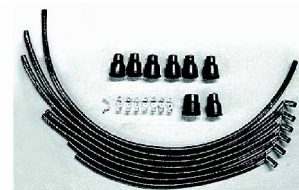
Ballast Resistor



1931614.....**ALL**
For 12v (coil). External resist coil only. (02.173-3)
\$9.00 EA

Restoration Parts

Spark Plug Wire Set



5298107.....**34-54**
Superb reproduction w/ GM stamped ends (02.239-15)
\$18.00 SET

O-rings



3652191.....**29-59**
Rubber holds plug wires (02.251-4)
\$2.00 SET

50T

Providing part #'s speeds up your order, improves accuracy, and helps us maintain low prices.

See Illustration Index for core charge information and a list of abbreviations. For Body Model information, see 5T.



50T: Ignition Systems, Ignition Switches, Vacuum Advances & Distributors

Format = Part No., Year, Description, original Chevrolet Part Book Group No., Price and Unit Measure.

Spark Plugs

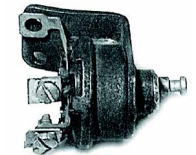


1559494.....33-54
Genuine AC14 mm plug
(exc 41-48) (6 pcs)
(02.270-4)
\$17.75 SET



1559459.....41-48
Genuine AC 10 mm
plug (6 pcs) (02.270-4)
\$18.60 SET

Reverse Polarity Switch



1889827.....41-42
On starter, w/ 1in. x 1-
1/2in. base (NOS)
(02.117-4)
\$38.00 EA



1907122.....46-48
On starter (NOS)
(02.117-4)
\$44.00 EA



1881929.....41-48
Wiring harness for
reverse polarity switch.
(02.122-15)
\$18.00 EA

Points



1855720.....33-40
2-1/8in. overall length
(02.384-15)
\$5.50 SET



1882391.....41-48
With polarity reversing
switch (1-3/4in. overall
length) (02.384-15)
\$9.00 SET

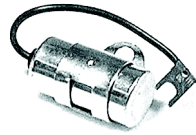


1855720.....48-53
All (exc 48 w/ polarity
reversing switch & 53
235ci 2-1/8in. overall
length) (02.384-15)
\$5.50 SET



1924571.....53-57
All (exc 216ci, 2-3/16in.
overall length)
(02.384-15)
\$7.75 SET

Condenser



1928111..... 37-54
(02.393-4)
\$4.50 EA

Hold Down Screw



816784..... ALL
Condenser & points
(02.387-4)
\$0.50 EA

Rotor



820445..... 33-52
All exc CC, DC & 53
235ci (02.382-2)
\$4.50 EA



1924245..... 53-57
All, exc 53 216ci
(02.382-4)
\$3.00 EA

Distributor Cap

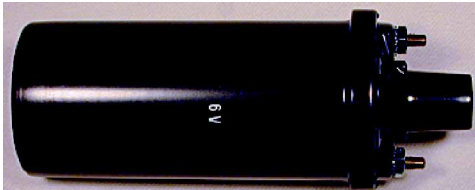


824735..... 33-53
Except 53 235ci
(02.364-15)
\$14.50 EA



1924248..... 53-54
With 235ci, 261ci
(02.364-2)
\$12.50 EA

Ignition Coil

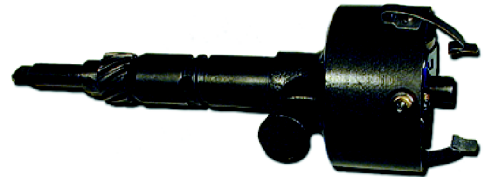


1115380A..... 47-54
6v, replacement (02.170-3)
\$40.00 EA

Distributor



1112362..... 40-53
Exc 53 powerglide (\$35 core) (02.361-15)
\$80.00 EA



1112358..... 53-57
Exc 53 stick (\$35 core) (02.361-15)
\$80.00 EA

Delco Remy Metal Tag

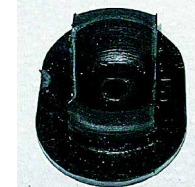


PLATE07..... 37
Generator, starter & dist (19.400-3)
\$10.00 EA



PLATE05..... 38-54
Generator, starter & dist (19.400-15)
\$6.00 EA

Timing Hole Plug



836802A..... ALL
Rubber, rare
(00.714-15)
\$5.50 EA

Returns require a return authorization number, please call.

50T: Ignition Systems, Ignition Switches, Vacuum Advances & Distributors



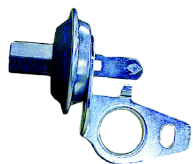
Format = Part No., Year, Description, original Chevrolet Part Book Group No., Price and Unit Measure.

Vacuum Advance

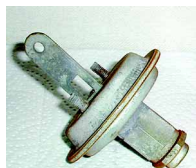
\$10 shipping & handling fee for rebuild service.



1116076R.....37-54
Rebuild service (your core) (02.410-15)
\$86.50 EA

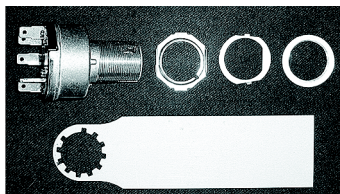


1909343A 39-62
W/ bracket & timing mark 90 degrees to vacuum chamber. (02.410-15)
\$40.00 EA

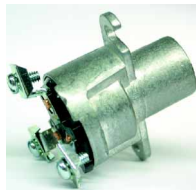


1909343 39-62
Less bracket, NOS. (02.410-3)
\$75.00 EA

Ignition Switch



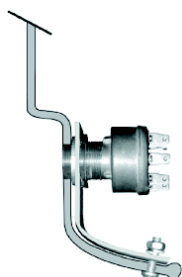
1116452A..... ALL
Are you using a fork lift ignition switch? Use our flush mount switch w/ mounting bracket. Use lock cylinder #1458180 or #3716725 with original keys. (02.188-15)
\$28.50 SET



1116452 40-54
A bolt-in replacement, w/ start & accessory position (6v or 12v), needs original key & lock cylinder (see #1458180 or #3716725). (02.188-3)
\$29.00 EA

111645247-53
Reproduction. Bolts in like original. Screw terminal. Foot starter only. (02.188-15)
\$30.00 EA

Ignition Switch Mounting Plate



3688155.....ALL
Universal mounting plate conforms to your dash to mount your switch (cylinder not included). (02.192-3)
\$6.00 EA

Ignition Lock



1458180..... 35-57
Cylinder & non-GM keys. Exc 48-57 Passenger. (02.188-4)
\$13.00 EA



3716725..... 47-48
Cylinder & keys (non GM). (02.188-4)
\$18.00 EA

Key



601272..... 35-54
Original GM round head. Fits trunk, glove box & locking gas cap (02.187-3)
\$2.00 EA



3694624..... 35-57
Original GM octagon head. Fits ignition, door & spare tire locks. (02.187-2)
\$1.50 EA

Odds & Ends

Please call for availability on all Odds & Ends parts; once part is sold, it may no longer be in stock.

184743234-37
Armature (Starter) All exc Dc (02.279-0)
\$25.00 EA

186515537-38
Bracket, Distributor Vac Control (02.410-0)
\$30.00 EA

186957337-38
Bracket, Holds Condensor 8cyl Use w/ # 1112330 (NOS) (02.393-0)
\$0.75 EA

Odds & Ends

1112363 51-52
Distributor, w/o contact plate (NOS) (02.361-0)

\$75.00 EA

11123624 40-53
Distributor with points and cond (Used). (02.361-0)

\$75.00 EA

1847643 33-56
Dual point breaker plate (02.385-0)

\$45.00 EA

1853749U 33-34
Electric lock cable (no key cylinder) (02.188-0)

\$50.00 EA

875 38-51
Ignition Coil NOS GMC w/ Fins (02.170-0)

\$50.00 EA

1916805 51-53
Insulator, Inner, for Distributor (03.000-0)

\$2.00 EA

1855520 39-48
Points (06.168-0)

\$15.00 EA

1851208 ALL
Spark plug wire. 7MM, compression type. Sold by the foot (2.241-0)

\$2.00 FT

1848515 33-37
Vacuum Control Fits CA, DA, EA, ED, FA, FD & GA (02.410-0)

\$50.00 EA.

50T

Providing part #'s speeds up your order, improves accuracy, and helps us maintain low prices.

See Illustration Index for core charge information and a list of abbreviations. For Body Model information, see 5T.



55T: Horns & Related

Format = Part No., Year, Description, original Chevrolet Part Book Group No., Price and Unit Measure.

Street Rod Parts

Horn



HORN3
Ooogah horn. Heavy duty 12 volt motor. Easy installation. Limited lifetime warranty. (02.810-2)
\$39.00 EA

Restoration Parts

Horns



9000518 40-54
W/ relay, 12v (pair), replacement. (02.810-15)
\$60.00 SET

Horn Button Contact



265316 41-46
W/ spring. Fits COE only. (02.819-3)
\$10.00 EA



759037 47-57
Contact w/ spring. Fits 37-57 (trucks). (02.819-15)
\$9.50 EA

Horn Contact Plate



758239 47-53
Horn button snaps over this plate. (02.819-0)
\$16.00 EA



758566 54-59
Horn button snaps over. (02.819-15)
\$18.00 EA

Horn Button Assembly



753838 29-40
W/ s-wire, rubber button & metal cap (02.817-15)
\$25.00 SET

Horn Button S-wire



753838B 29-40
(02.817-0)
\$5.50 EA

Horn Button



753838C 29-40
Metal cap on rubber horn button. (02.817-0)
\$9.00 EA

609620 41-46
Base metal. 41-46 all commercial & utility (exc COE). (02.817-15)
\$28.00 EA



755850 47-53
Chrome & painted. (02.820-15)
\$32.38 EA

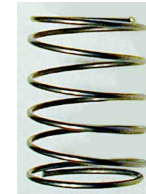
3720100 54
Chrome & painted. (02.820-15)
\$25.00 EA

Horn Button Pad



753838A 29-40
Rubber. (02.817-0)
\$9.00 EA

Horn Button Spring



755284 41-46
(02.816-4)
\$9.00 EA

Horn Relay



1116775A 34-54
6v, replacement. (02.815-15)
\$16.50 EA

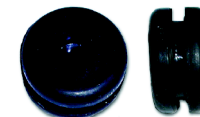


1116775B ALL
12v (02.815-3)
\$9.00 EA

Horn Wire Grommet



9000516 40-54
Horn wire thru horn cover (2 pcs). (02.810-4)
\$4.75 SET



3711896 41-46
Horn wire thru steering column. (09.775-15)
\$3.00 EA

Returns require a return authorization number, please call.



Format = Part No., Year, Description, original Chevrolet Part Book Group No., Price and Unit Measure.

The HIGHWAY 22 Modular Fuse Panel System by American Autowire



The *HIGHWAY 22* is a full-featured fuse panel system. It's a smaller, more compact front-loading package which components exceed the power handling capability of all competitors and is unmatched in safety and reliability. Flexible mounting location, fool-proof illustrated instructions to make your wiring job simple! Take a look at the following features and see why this is the best full-featured power distribution panel on the market today! A popular and versatile system for Street Rods, Customs and Kit Cars.



System

Modular Design with compact front loading. "Over-Engineered" for Street Rods, Customs and Kit Cars with 22 Power Circuits.

System Protection

Our "Mega-Box" with 175A fuse located at starter/alternator to protect panel.

Feeds

Alternator 8 Gauge, Battery and accessory stud connection on panel.

Panel

7 1/2" x 4 1/2" footprint, 3 3/8" high. Heat resistant nylon 6/6. Modular "American Blox" allows expansion. Yellow "anti-push back" locks. Single side wire access. Self locking screw down connection utilizing Hook's Law. Mounted on Nylon base plate.

Wire

High temp GXL -60°F to 275°F. Abrasion resistant cross-link construction. Large easy to read circuit printing on every GM color coded wire.

Panel Connections

- | | |
|--------------------|----------------------|
| 1 Fan Power Out | 12 Radio |
| 2 Fan Relay Ground | 13 Park |
| 3 Ignition 2 | 14 Accy 2 |
| 4 Wiper | 15 Headlights |
| 5 Battery 2 | 16 Accy 1 |
| 6 Dome | 17 Gauges |
| 7 Stop | 18 Horn out |
| 8 Fuel Pump | 19 Horn Switch |
| 9 Heat / AC | 20 Hazard |
| 10 Ignition EFI | 21 Turn |
| 11 Bat 1 EFI | 22 Turn Relay Ground |



\$429⁰⁰
pt#13238

Your #1 Source for wiring!



We Make Wiring Easy!

Switches

Head Light - 3 Position with Internal Circuit Breaker.
Ignition - dash Ignition included and column connectors included.
Dimmer - floor mounting.

Wiring Harness Kits

Ignition Switch and Starter Kit, Alternator Conversion Kit, Head Light Switch Kit, Steering Column /Turn Signal Kit, Accessory Connection Kit, Gauge Connection Kit, All Needed Terminals & Connectors for basic system

Instructions

Second to none. Full color schematic with component symbols and step by step instructions for trouble-free installation. In addition, each harness kit has its own detailed instructions.

Components

Relays - 40 AMP fan or fuel pump. 2 micro-relays for horn & turn signals
Flasher - hazard & turn signal
Fuses - 15 Fuses, 1 circuit breaker
Power Studs - Battery in, Accessories in
Power Connections - 22 self-locking screw down
"Stud-Blox" - for battery and accessories. Allows for expansion.

Bottom-Line

"Rock-Solid" wiring kit designed to give you a trouble free system with a level of comfort you can trust.



60T

Providing part #'s speeds up your order, improves accuracy, and helps us maintain low prices.

See Illustration Index for core charge information and a list of abbreviations. For Body Model information, see 5T.

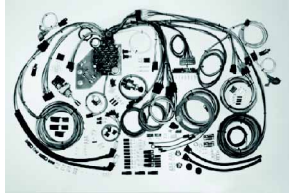


60T: Wiring Harness, Wiring Clips, Terminal Boards

Format = Part No., Year, Description, original Chevrolet Part Book Group No., Price and Unit Measure.

Street Rod Parts

Main Wire Harness-Street Rod



2960053SR..... 47-55
 Built on the new 18 fuse, 21 circuit fuse box system, kit comes completely ready to install under the dash. Includes modern fuse box, instruction sheet, dash harness, instrument cluster kit, parking lamp kit, rear body kit, power plus front lighting kit, engine & starter kit, courtesy light connection kit, fuse relay flasher kit, ignition switch, headlight switch, dimmer switch and wire ties. (02.555-15)
\$499.00 KIT



13238..... ALL
 Includes modern fuse box, instruction sheet, dash harness, instrument cluster kit, parking lamp kit, rear body kit, power plus front lighting kit, engine & starter kit, courtesy light connection kit, fuse relay flasher kit, ignition switch, headlight switch, dimmer switch and wire ties. (02.555-15)
\$429.00 KIT

Restoration Parts

Main Wire Harness-Chevrolet

Note: Turn signals are located in Section 80T.

Note: Our cloth-covered wiring harnesses below are superb reproductions with braided harness cover and numbered ends for easy installation.

Main Wire Harness-Chevrolet



- 1865315..... 37-38**
Original cloth (02.555-15)
\$404.50 EA
- 1872970..... 39**
Original cloth (02.555-15)
\$393.75 EA
- 1872970A..... 39**
Original cloth (fits fire truck, commercial, etc.) (02.555-15)
\$393.75 EA
- 1879561..... 40**
Original cloth (02.555-15)
\$512.25 EA
- 4284502..... 41-46**
Original cloth (02.55 -15)
\$512.25 EA
- 4188864..... 47-49**
Original cloth (02.555-15)
\$612.75 EA
- 5299874..... 50-53**
Original cloth (02.555-15)
\$612.75 EA

Some 1953 & all 1954 trucks used plastic wiring harnesses.

Main Wire Harness-GMC



- 1865315G..... 37**
GMC, original cloth, special order (02.555-15)
\$575.75 EA
- 1879561G..... 40**
GMC, original cloth, special order (02.555-15)
\$666.00 EA
- 4284502G..... 41**
GMC, original cloth, special order (02.555-15)
\$656.00 EA

Main Wire Harness-GMC

- 5284496G..... 46**
GMC, original cloth, special order (02.555-15)
\$441.50 EA
- 4188864G..... 47-49**
GMC, original cloth, special order (02.555-15)
\$656.00 EA
- 5299874G..... 50-52**
GMC, original cloth, special order (02.555-15)
\$614.00 EA
- 5299874A..... 53**
GMC, original cloth, special order (02.555-15)
\$678.75 EA
- 5299874B..... 53**
Transmission harness. GMC, for hydramatic original cloth, special order (02.555-15)
\$138.75 EA

Some 1953 & all 1954 trucks used plastic wiring harnesses.

Main Wire Harness- Replacement Chevrolet

Note: Plastic wiring harnesses include turn signal harness. Plastic kits come with extra wire for second tail light.



- 1865315P..... 37-39**
Plastic, generator (02.555-15)
\$180.50 EA
- 1865315PV..... 37-39**
Plastic, alternator (02.555-15)
\$180.50 EA
- 4284502P..... 40-46**
Plastic, generator (02.555-15)
\$185.50 EA
- 4284502PV..... 40-46**
Plastic, alternator (02.555-15)
\$185.50 EA
- 4188864P..... 47-49**
Plastic, generator (02.555-15)
\$180.50 EA

Returns require a return authorization number, please call.

60T: Wiring Harness, Wiring Clips, Terminal Boards



Format = Part No., Year, Description, original Chevrolet Part Book Group No., Price and Unit Measure.

Main Wire Harness- Replacement Chevrolet

- 4188864PV**47-49
Plastic, alternator (02.555-0)
\$150.00 EA
- 5299874P**50-52
Plastic, generator (02.555-0)
\$150.00 EA
- 5299874PV**50-52
Plastic, alternator (02.555-0)
\$150.00 EA
- 2960053P**53-54
Plastic, generator (02.555-0)
\$150.00 EA
- 2960053PV**53-54
Plastic, alternator (02.555-0)
\$150.00 EA

Main Wire Harness- Replacement GMC

Note: Order GMC wire harnesses when you want to add electric temperature and oil pressure gauges to your Chevrolet truck.



- 1865315T**37-39
Plastic, GMC, generator (02.555-15)
\$180.50 EA
- 1865315TV**37-39
Plastic, GMC, alternator (02.555-15)
\$180.50 EA
- 4284502T**40-46
Plastic, GMC, generator (02.555-15)
\$185.50 EA
- 4284502TV**40-46
Plastic, GMC, alternator (02.555-15)
\$185.50 EA
- 4188864T**47-49
Plastic, GMC, generator (02.555-15)
\$180.50 EA
- 4188864TV**47-49
Plastic, GMC, alternator (02.555-15)
\$185.50 EA
- 5299874T**50-52
Plastic, GMC, generator (02.555-15)
\$180.50 EA

Main Wire Harness- Replacement GMC

- 5299874TV**50-52
Plastic, GMC, alternator (02.555-15)
\$185.50 EA
- 2960053T**53-54
GMC, plastic, w/ generator (02.555-15)
\$180.50 EA
- 2960053TV**53-54
GMC, plastic, w/ alternator (02.555-15)
\$185.50 EA

Headlight Pigtails



- 918977**37-39
Exc COE (02.750-15)
\$43.00 PR
- 5931796**41-46
And park light (02.750-15)
\$49.00 EA



- 5942312**47-55
W/ grommets (02.750-15)
\$25.00 PR

Note: Turn signals are located in Section 80T.

Heater Harness



- 3106048B** 37-49
Heater & defroster
(08.853-0)
\$46.50 EA

Horn Harness



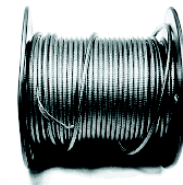
- 1997713A** 37-42
Town & Country horn (02.832-15)
\$59.75 EA

Wire Loom



- 1846572** ALL
Black, original hard cover to protect wiring,
1/4in. i.d. (02.530-3)
\$0.75 FT
- 1846574** ALL
Black, original hard cover to protect wiring,
5/16in. i.d. (02.530-3)
\$1.00 FT
- 1846573** ALL
Black, original hard cover to protect wiring,
3/8in. i.d. (02.530-2)
\$0.75 FT
- 1846575** ALL
Black, original hard cover to protect wiring,
7/16in. i.d. (02.530-3)
\$1.00 FT
- 1846576** ALL
Black, original hard cover to protect wiring,
1/2in. i.d. (02.530-2)
\$1.00 FT

Wire



- 985776A** ALL
Armored steel covered. (09.773-4)
\$0.10 IN

60T

Providing part #'s speeds up your order, improves accuracy, and helps us maintain low prices.

See Illustration Index for core charge information and a list of abbreviations. For Body Model information, see 5T.



60T: Wiring Harness, Wiring Clips, Terminal Boards

Format = Part No., Year, Description, original Chevrolet Part Book Group No., Price and Unit Measure.

Wire

985777W **ALL**
Lacquer coated braided, white. (09.773-4)
\$0.05 IN

Clamp



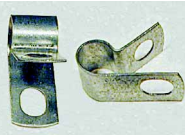
120521 **ALL**
1/4in. bolt-on strap. For wire or tube (4 pcs). (08.950-4)

\$2.50 SET



120521A..... **ALL**
5/16in, insulated bolt-on strap. For wire or tube (4 pcs) (08.950-4)

\$2.50 SET



120521B..... **ALL**
3/8in. bolt-on strap. For wire or tube (4 pcs). (08.950-4)

\$2.50 SET

Clip



3735074A..... **ALL**
1/8in. slot, wiring or tubing (4 pcs) (08.950-4)

\$5.00 SET



3735074C..... **ALL**
3/8in. slot, gas, brake line, wire harness (4 pcs). (08.950-4)

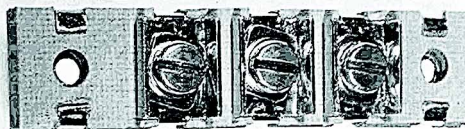
\$4.00 SET



148129 **ALL**
(9/16in. Slot) wiring or tubing (4 Pcs) (08.950-4)

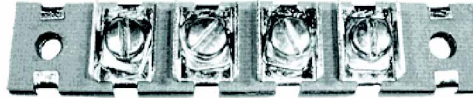
\$6.00 SET

Terminal Boards



1865535 **40-53**
(3 terminal) main wiring to headlight & park light pigtailed w/ rivets. (02.560-3)
\$20.00 PR

Terminal Boards



1998756..... **40-54**
(4 terminal) main wiring to headlight & park light pigtailed w/ rivets. (02.560-3)
\$24.00 PR

Odds & Ends

Please call for availability on all Odds & Ends parts; once part is sold, it may no longer be in stock.

1913990..... **38-52**
Generator comutator end frame (NOS) Fits 38-39 PASS, COE, 40-52 ALL (02.297-0)
\$20.00 EA

1848532..... **34-37**
Spring Starter Motor (03.000-0)
\$10.00 EA.

1385.....
Start switch on dash-pushbutton, black (03*000-0)
\$20.00 EA.

1913369B **55-57**
Starter 12v Foot Start (00.000-15)
\$66.50 EA

Returns require a return authorization number, please call.

80T: Turn Signals, Park Lights



Format = Part No., Year, Description, original Chevrolet Part Book Group No., Price and Unit Measure.

Street Rod Parts

Turn Signal Kit-W/ Harness



9857206TK..... 37-53
W/ (2) 6v halogen bulbs, wire harness, flasher sockets & switch (specify year when ordering). (02.761-0)
\$190.00 SET



9857212TK..... 37-53
W/ (2) 12v halogen bulbs, wire harness, flasher sockets & switch (specify year when ordering). (02.761-0)
\$190.00 SET

Turn Signal Kit-No Harness



9857207TK..... 37-53
W/ (2) 6v halogen bulbs, flasher sockets & switch, w/out wire harness (specify year when ordering). (02.761-0)
\$83.00 SET



9857208TK..... 37-53
W/ (2) 12v halogen bulbs, flasher sockets & switch, w/out wire harness (specify year when ordering). (02.761-0)
\$83.00 SET

Park Light Bulb-LED



145416K.....ALL
LED super bright amber. Minimal current draw. 12v, straight pin, replaces bulb #1156. Use LED flasher #3713382L. (08.991-15)
\$12.00 EA

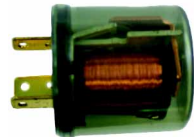


145416M.....ALL
LED super bright red. Minimal current draw. 12v, straight pin, replaces bulb #1156. Use LED flasher #3713382L. (08.991-15)
\$12.00 EA

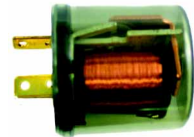
Turn Signal Flasher-LED

FF552NLP..... ALL
12v. For use w/ LED lights (2 prong). Adjustable pulsing blinker speed. (02.892-15)
\$50.00 EA

FF552NL..... ALL
12v. For use w/ LED lights (2 prong). Adjustable blinker speed. (02.892-15)
\$40.00 EA



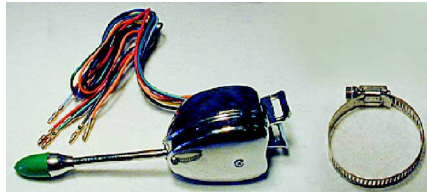
3713382L.....ALL
12v. For use w/ LED lights (3 prong). (02.892-3)
\$16.25 EA



3713382L2.....ALL
12v. For use w/ LED lights (2 prong). (02.892-3)
\$16.25 EA

Restoration Parts

Turn Signal Switch



985720E..... ALL
Economy (02.895-15)
\$16.00 EA



985720..... ALL
Superior (02.895-2)
\$25.00 EA



5944127..... 54-62
(02.895-15)
\$25.00 EA

Turn Signal Harness



985720A39..... 37-39
Cloth, w/ flasher socket, extra pigtail for park lights and instructions (02.761-0)
\$126.25 EA

985720A40..... 40
Cloth, w/ flasher socket, extra pigtail for park lights and instructions (02.761-0)
\$126.25 EA

985720D42..... 41-42
Wire harness, plastic, w/ flasher socket, extra pigtail for park lights and instructions. (02.761-0)
\$111.00 EA

985720D46..... 42-46
Wire harness, plastic, w/ flasher socket, extra pigtail for park lights and instructions. (02.761-0)
\$111.00 EA

985720D53..... 47-53
Wire harness, plastic, w/ flasher socket, extra pigtail for park lights and instructions. (02.761-0)
\$111.00 EA

Turn Signal Knob



5939511A..... 54-59
(02.906-15)
\$9.00 EA

Turn Signal Flasher



5947767..... 40-50
6-volt (NOS). (02.892-2)
\$30.00 EA



1335230..... ALL
6v (02.892-3)
\$6.50 EA



3713382..... ALL
12v (02.892-3)
\$7.00 EA

80T

Providing part #'s speeds up your order, improves accuracy, and helps us maintain low prices.

See Illustration Index for core charge information and a list of abbreviations. For Body Model information, see 5T.



80T: Turn Signals, Park Lights

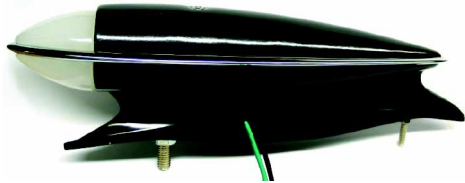
Format = Part No., Year, Description, original Chevrolet Part Book Group No., Price and Unit Measure.

Flasher Socket



5297633 ALL
W/ mounting bracket
(02.892-2)
\$6.50 EA

Park Light Assembly, 1937-39



916957T 37-39
Accessory. Complete with turn signal.
(02.585-15)
\$100.00 EA



916957 37-39
Accessory. Complete assembly
(02.585-15)
\$74.50 EA



1873702S 37-39
6v socket & bulbs for park lights with turn signals. May require modification.
(02.750-2)
\$19.00 SET

1873702U 37-39
12v socket & bulbs for park lights with turn signals. (02.750-3)
\$19.25 SET



595825 37-39
Retainer plate & wire guide for park light
(02.585-15)
\$27.50 L&R

Park Light Assembly, 1937-39



920249 37-39
Park light lens.
Accessory (02.589-15)
\$11.00 EA



603313 37-39
Mounting Pads. Park light to fender (2 pcs)
(02.599-15)
\$11.00 PR

Park Light Assembly, 1940

5930046S 40
6v socket & bulbs for park lights with turn signals. (02.750-15)
\$27.00 SET

5930046U 40
12v socket & bulbs for park lights with turn signals. (02.750-15)
\$27.00 SET



924854P 40
Park light lens. Plastic, good (Used). (02.589-2)
\$25.00 EA



922758 40
Park light lens gasket.
(02.590-15)
\$3.00 PR



5930230 40
Park light rim.
(02.593-15)
\$20.00 EA



923315 40
Park light rim screws. Stainless steel (2 pcs)
(02.688-4)
\$0.75 SET



3650817 40
Mounting pads. Park light to fender.
(02.599-3)
\$6.00 PR

Park Light Assembly, 1941-42

Halogen Bulbs can be added to following kits for an additional \$20.

5930153S 41-42
6v socket & bulbs for park lights w/ turn signals. (02.750-3)
\$19.50 SET

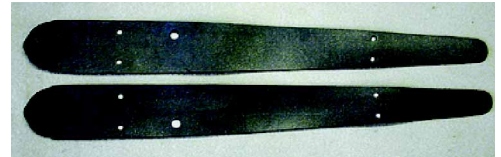
5930153U 41-42
12v socket & bulbs for park lights w/ turn signals. (02.750-4)
\$19.50 SET



5930136P 41-42
Park light lens. Plastic, 4in. long for die cast housing. (02.589-15)
\$25.00 EA



5930153 41-42
Lens gasket. 4in. Long.
(02.590-2)
\$4.50 PR



917012 41-42
Mounting pads for park light w/ die cast base (2 pcs). (02.599-15)
\$7.00 PR

Park Light Assembly, 1942-46

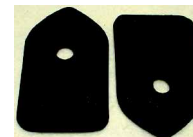
Halogen Bulbs can be added to following kits for an additional \$20.

5032299S 42-46
6v socket & bulbs for park lights w/ turn signals. (02.750-2)
\$16.00 SET

5032299U 42-46
12v socket & bulbs for park lights w/ turn signals. (02.750-4)
\$18.00 SET



5932977 42-46
Park light lens. 2in. long for tin cover housing.
(02.589-15)
\$10.00 EA



5932999 42-46
Lens gasket. 2-3/16in. long (2 pcs). (02.590-2)
\$3.00 PR

Returns require a return authorization number, please call.

80T: Turn Signals, Park Lights



Format = Part No., Year, Description, original Chevrolet Part Book Group No., Price and Unit Measure.

Park Light Assembly, 1942-46



5932996A.....42-46
Mounting pads for park light w/ 1 pc tin cover (2 pcs). (02.599-3)
\$12.00 PR

Park Light Assembly, 1947-53



928665.....47-53
Assembly. Clear, 6v. (02.585-15)
\$40.00 EA

928665B.....47-53
Assembly. Clear, 12v, double element bulb for turn signals. (02.585-15)
\$48.00 EA

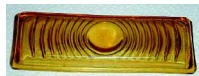
928664.....47-53
Assembly. Amber, 12v, double element bulb for turn signals. (02.585-15)
\$44.00 EA

5936804S.....47-53
6v socket & bulbs for park lights w/ turn signals.(02.750-3)
\$18.00 SET

5936804U.....47-53
12v socket & bulbs for park lights w/ turn signals.(02.750-4)
\$18.00 SET



5936802G..... 47-50
Park light lens. GMC (02.589-15)
\$22.00 EA



5936801..... 47-53
Park light lens. Amber, glass. (02.589-2)
\$12.50 EA



5936802..... 47-53
Park light lens. Clear, glass lens. (02.589-2)
\$7.00 EA

Park Light Assembly, 1947-53



5935955..... 51-53
Park light lens. GMC, includes gasket #5936805G. (02.589-15)
\$15.00 EA



5936795..... 47-53
Park light rim (02.593-15)
\$8.00 EA



5942152..... 47-53
Rim screws. 4 pcs. (02.594-4)
\$1.25 SET



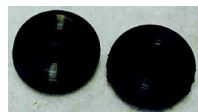
5936804G..... 47-50
Lens gasket. GMC (2 pcs). (02.590-15)
\$3.00 PR



5936805G..... 51-53
Lens gasket. GMC (2 pcs). (02.590-15)
\$3.00 PR



5936804..... 47-53
Lens gasket. 2 pcs. (02.590-3)
\$3.25 SET



928665A..... 47-54
Park light wire-thru housing grommet. (02.596-2)
\$3.00 PR



5936003G..... 47-50
Mounting pads for GMC park light (2 pcs). (02.599-2)
\$5.00 SET



5936003F..... 52-53
Mounting pads for GMC park light (2 pcs). (02.599-15)
\$10.00 SET

Park Light Assembly, 1954



897429..... 54-55
55 1st series. (02.585-15)
\$40.00 EA

Park Light Assembly, 1954

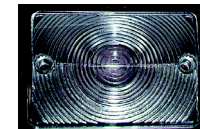
Park light socket and bulb kits also available with halogen or LED bulbs.



5942094..... 54
Park light body with chrome rim. (02.586-15)
\$26.00 EA

5942094S..... 54
6v socket & bulbs for park lights w/ turn signals. (02.596-3)
\$16.00 SET

5942094U..... 54
12v socket & bulbs for park lights w/ turn signals.(02.750-4)
\$16.00 SET



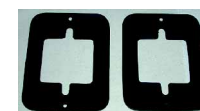
5942151..... 54
Park light lens. Clear (02.589-15)
\$8.00 EA



5942151A..... 54
Park light lens. Amber (02.589-15)
\$8.00 EA



5942513..... 54
Lens gasket. (02.590-4)
\$4.00 EA



897429A..... 54
Mounting pads for park light to fender. (02.599-15)
\$10.00 PR

Odds & Ends

Please call for availability on all Odds & Ends parts; once part is sold, it may no longer be in stock.

917012U..... 41-46
Parking lamp housing, left side (Used) (2.585-0)
\$25.00 EA

80T

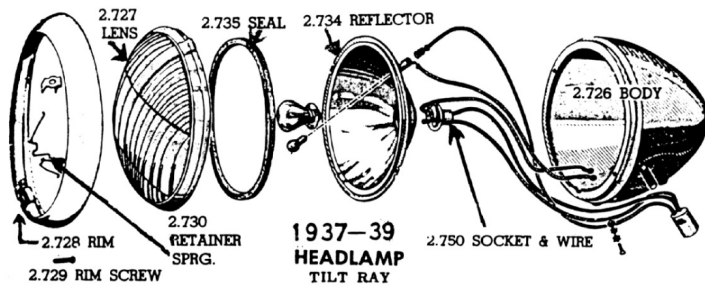
Providing part #'s speeds up your order, improves accuracy, and helps us maintain low prices.

See Illustration Index for core charge information and a list of abbreviations. For Body Model information, see 5T.

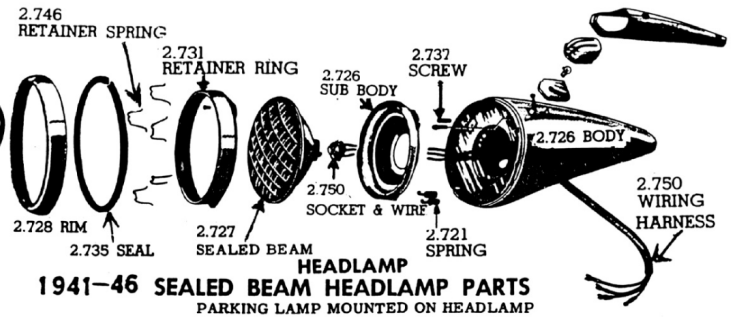


85T: Driving Lights, Fog Lights & Spot Lights

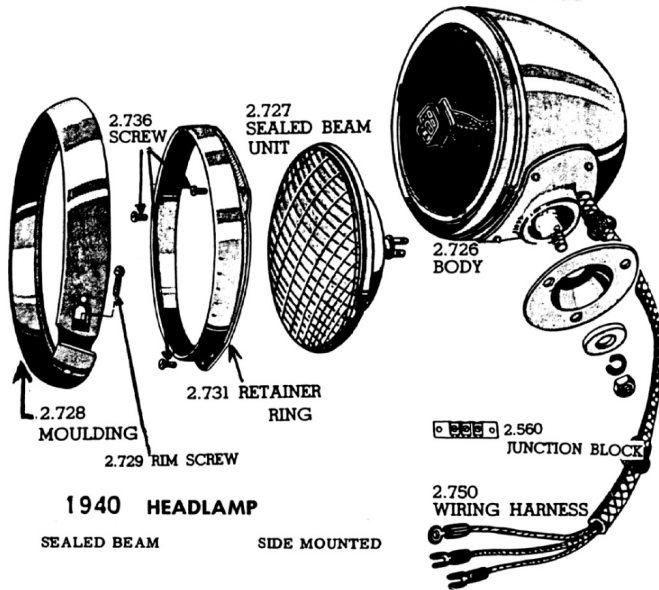
Format = Part No., Year, Description, original Chevrolet Part Book Group No., Price and Unit Measure.



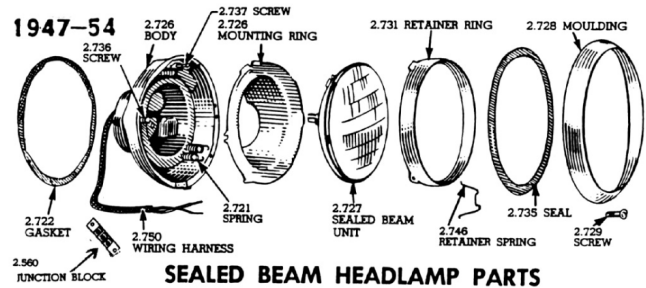
1937-39 HEADLAMP TILT RAY



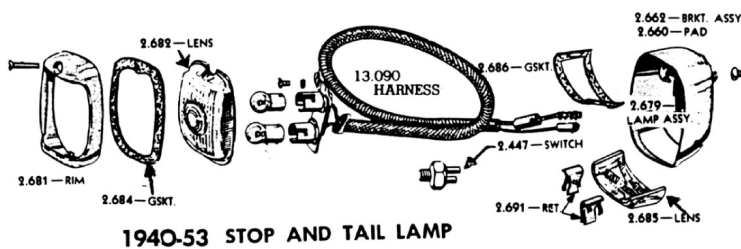
1941-46 SEALED BEAM HEADLAMP PARTS PARKING LAMP MOUNTED ON HEADLAMP



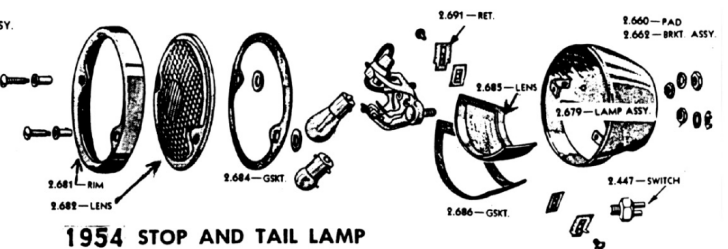
1940 HEADLAMP SEALED BEAM SIDE MOUNTED



SEALED BEAM HEADLAMP PARTS



1940-53 STOP AND TAIL LAMP



1954 STOP AND TAIL LAMP

Returns require a return authorization number, please call.

85T: Driving Lights, Fog Lights & Spot Lights



Format = Part No., Year, Description, original Chevrolet Part Book Group No., Price and Unit Measure.

Driving Lights

Note: Fog and driving lights are GM script w/ brackets, switch & wiring. Fog lights are amber, driving lights are clear.

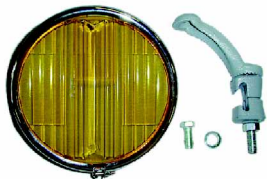


- 409185..... ALL**
Clear, 6v, 5in. (specify year when ordering). (09.774-0)
\$164.00 PR
- 409185A..... ALL**
Clear, 12v, 5in. (specify year when ordering). (09.774-3)
\$124.00 PR
- 409186..... ALL**
Clear, 6v, 6in. (specify year when ordering). (09.774-0)
\$164.00 PR
- 409186A..... ALL**
Clear 12v, 6in. (specify year when ordering). (09.774-0)
\$124.00 PR

Fog Light



- 985174.....37-38**
Nice repro w/ brackets. (09.774-15)
\$275.00 PR



- 985444.....39**
Nice repro w/ brackets. (09.774-15)
\$300.00 PR

Fog Light



- 409182..... ALL**
Amber with GM script. 6v, 5in. dia. (specify year when ordering). (09.774-0)
\$164.00 PR
- 409182A..... ALL**
Amber. 12v with GM script w/ bracket. 5 dia. (specify year when ordering). (09.774-3)
\$124.00 PR
- 409183..... ALL**
Amber with GM script. 6v, 6in. dia. (specify year when ordering). (09.774-0)
\$164.00 PR
- 409183A..... ALL**
Amber with GM script. 12v, 6in. dia. (specify year when ordering). (09.774-2)
\$124.00 PR

Fog Light Lens



- 921415.....37-38**
Amber (09.774-15)
\$19.25 EA



- 923706.....39**
Amber (original repro). (09.774-15)
\$23.00 EA

Fog Light Rim



- 5930366..... 40**
Chrome (NOS). (09.774-0)
\$40.00 EA

Fog Light Emblem



- 984716E.....41**
(09.774-15)
\$24.50 EA

Fog Light Bracket



- 5933244..... ALL**
W/ apron on bumper brackets. (09.774-3)
\$34.00 SET

Switch



- 924160..... ALL**
Fog light, backup light, etc, rotary. Clamps to dash bottom. (09.774-3)
\$20.00 EA

Note: Headlight and spotlight bulbs see Section 100T.

Spotlight

Note: Spotlights have GM script and include right or left bracket and template.

- 985993H..... ALL**
6v, 5in. (specify year & left or right when ordering). (09.773-0)
\$131.00 EA



- 985993A..... ALL**
6v, 6in., (specify year & left or right when ordering). (09.773-0)
\$131.00 EA

- 985993G..... ALL**
12v, 5in. (specify year & left or right when ordering). (09.773-0)
\$131.00 EA

- 985993F..... ALL**
12v, 6in., (specify year & left or right when ordering). (09.773-0)
\$131.00 EA

85T

Providing part #'s speeds up your order, improves accuracy, and helps us maintain low prices.

See Illustration Index for core charge information and a list of abbreviations. For Body Model information, see 5T. 69



85T: Driving Lights, Fog Lights & Spot Lights

Format = Part No., Year, Description, original Chevrolet Part Book Group No., Price and Unit Measure.

Spotlight Bracket



985993TR.....ALL
Right (specify year when ordering).
(09.773-0)
\$32.25 EA

985993TL.....ALL
Left (specify year when ordering).
(09.773-0)
\$32.25 EA

Spotlight Handle



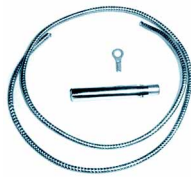
985998B..... ALL
Ivory w/ chrome housing & switch for spotlight. (09.773-15)
\$45.00 EA

GM Script Tag



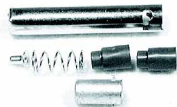
985993M.....37-54
Top of driving lights, fog light and spotlight.
(09.773-2)
\$5.50 EA

Wire Assembly



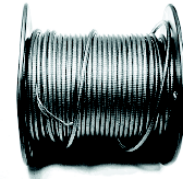
985774A..... ALL
W/ armored steel covered, cloth wire & metal fuse holder for spotlight, as original.
(09.773-2)
\$18.50 SET

Fuse Holder



985775A..... ALL
Metal fuse holder.
(09.773-15)
\$7.50 EA

Wire



985776A.....ALL
Armored steel covered. (09.773-4)

\$0.10 IN

985777W.....ALL
Lacquer coated braided, white. (09.773-4)
\$0.05 IN

Odds & Ends

Please call for availability on all Odds & Ends parts; once part is sold, it may no longer be in stock.

5931921U.....ALL
Bracket fog lamp (09.774-0)
\$10.00 EA



1940 Panel

Returns require a return authorization number, please call.

90T: Headlight Components & Headlight Switches



Format = Part No., Year, Description, original Chevrolet Part Book Group No., Price and Unit Measure.

Street Rod Parts

1940's Headlight Assembly



NEW! Classic 682-C from the '40s is back. Nice reproduction. Accepts 7" sealed beam headlamps (not included) Glass parking light lens is duplicate of the original (choose clear or amber bulbs). Choose any combination of Chrome or Primed housings (headlight/ turn signal). Prices starting at \$395 Pair.

Headlight-Frenched Kit

Smooth the look of your front end. Complete weld-in kit to french your headlight buckets. Headlamps mount thru the front. Bucket dimensions: Flange=9in O.D., Can=8in. O.D. & 6 in. deep. Trim ring dimensions: 7-7/8in. O.D., 6 in. I.D. & 1in. deep. (Headlamps sold separately, see Section 100T.)

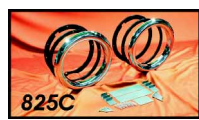


HAG4050C..... 40-57
Chrome and cool.
(02.726-15)
\$255.00 SET



HAG4050BS.... 40-57
Bare steel kit.
(02.726-15)
\$235.00 SET

These frenched headlight kits are designed to retro-fit your existing bullet shaped buckets. Complete installation instructions included. Bonded or weld-in mounting tabs. Refer to Section 100T for snake eye, blue dot lamps or sealed beams to fit these kits.



HAG825C..... 39
7 inch. Chrome trim rings.
(02.726-15)
\$235.00 SET



HAG825BS..... 39
7 inch. Bare steel trim rings.
(02.726-15)
\$190.00 SET

Headlight-Frenched Kit

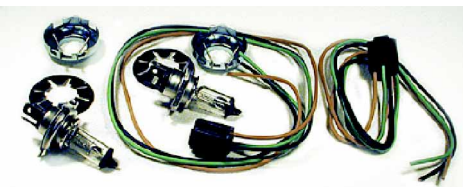


HAG775C..... 37-38
5-3/4 inch. Chrome trim rings.
(02.726-15)
\$235.00 SET



HAG775BS..... 37-38
5-3/4 inch. Bare steel trim rings.
(02.726-15)
\$190.00 SET

Halogen Headlight Conversion



110185D.....31-39
Halogen bulb. 6v headlight conversion. Double the light of a sealed beam, retains original appearance. Uses original lens & reflector. Clear. (08.991-15)
\$50.00 PR



110185A..... 31-39
Halogen bulb. 12v headlight conversion. Double the light of a sealed beam, retains original appearance. Uses original lens & reflector. Clear. (08.991-15)
\$36.00 PR

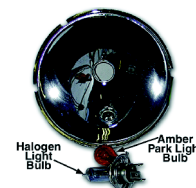


110185AB..... 31-39
Headlight bulb conversion. Blue Halogen, 12v, H4. (08.991-15)
\$56.00 PR

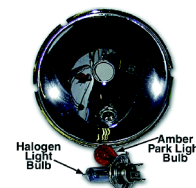


920773L.....37-39
Reflector w/ clear halogen headlight bulb & clear park light bulbs (6v). Universal fit. (02.734-15)
\$125.00 PR

Halogen Headlight Conversion



920773K..... 37-39
Reflector w/ clear halogen headlight bulb & amber park light bulbs (12v). Universal fit. (02.734-15)
\$120.25 PR



920773KB..... 37-39
Reflector w/ blue halogen headlight bulb & amber park light bulbs (12v). Universal fit. (02.734-15)
\$120.00 PR

Tri-Bar Headlight Cover-Blue Dot



193142TB..... ALL
Fits 7 inch headlights. (02.731-15)
\$18.50 SET



193142TBQ..... ALL
Fits 5-3/4 inch headlights. (02.731-15)
\$8.75 EA

Tri-Bar Headlight Cover-Chrome Bullet



193142TC..... ALL
Fits 7 inch headlights. (02.731-15)
\$13.50 SET



193142TCQ..... ALL
Fits 5-3/4 inch headlights. (02.731-15)
\$6.75 EA

Headlight Visor



193142D..... ALL
Chrome plated (02.731-4)
\$15.50 PR



193142B..... ALL
Chrome plated w/ blue dot jewel (02.731-4)
\$15.75 SET

90T

Providing part #'s speeds up your order, improves accuracy, and helps us maintain low prices.

See Illustration Index for core charge information and a list of abbreviations. For Body Model information, see 5T. 71



90T: Headlight Components & Headlight Switches

Format = Part No., Year, Description, original Chevrolet Part Book Group No., Price and Unit Measure.

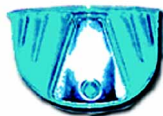
Headlight Visor



193142A..... ALL
Chrome half moon.
Covers top 1/3 of
headlight. (02.731-3)
\$9.00 PR



193142AM
Amber acrylic with
chrome trim plate. Fits 7
inch round headlights.
(02.731-15)
\$11.75 PR



193142BL
Blue acrylic with chrome
trim plate. Fits 7 inch
round headlights.
(02.731-15)
\$11.75 PR



193142GR
Green acrylic with
chrome trim plate. Fits 7
inch round headlights.
(02.731-15)
\$11.75 PR



193142RE
Red acrylic with chrome
trim plate. Fits 7 inch
round headlights.
(02.731-15)
\$11.75 PR

Restoration Parts

Headlight Bucket Assembly



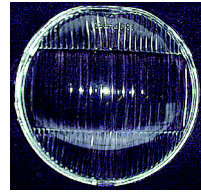
5932796D.....47-54
Complete w/ original
style pigtail in cloth
loom, retainer & 12v
bulb (no rim).
(02.726-15)
\$69.00 EA



5932796C.....47-54
Complete w/ pigtail,
retainer & 12v bulb, no
rim. (02.726-15)
\$50.00 EA

Note: Knobs see Section 340T.

Headlight Lens



923344 37-39
Glass replacement lens.
(02.727-0)
\$27.50 EA

Headlight Housing



919475F 37-40
Fiberglass (specify left
or right hand when
ordering). (02.726-15)
\$95.00 EA



917763..... 37-40
Replacement, NOS. (02.725-15)
\$150.00 L&R

917763..... 40-48
Military, NOS. (02.725-15)
\$150.00 L&R

925203F..... 41-46
Fiberglass (specify left or right hand when
ordering). (02.726-15)
\$95.00 EA

Pad-Headlight Bucket



5933134 41-46
Headlight bucket to
fender. (02.544-15)
\$10.00 PR

Gasket-Headlight Bucket



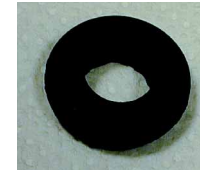
3722121 47-54
Headlight bucket to
fender. (02.722-15)
\$4.00 PR

Headlight Wire Grommet



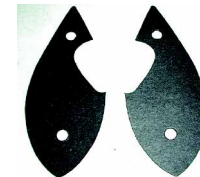
5931584 47-54
Bucket for pigtail (2
pcs). (09.775-2)
\$4.00 PR

Headlight Wire Grommet

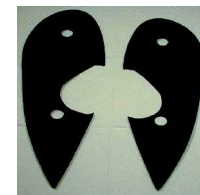


367313947-53
Fender inner panel.
(09.775-4)
\$3.00 SET

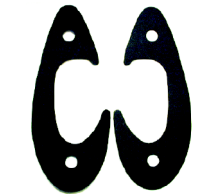
Headlight Stand Mounting Pad



47648937
(02.544-4)
\$8.00 L&R



59799238
(02.544-4)
\$8.00 L&R



35091039-40
(02.544-4)
\$8.00 L&R

Headlight Bucket



92453551-54
Inner bucket only. Steel
(also 55 6volt). (02.726-
15)
\$36.00 EA



5932796BC51-54
Outer only w/ pigtail.
Steel w/ plastic
insulated wires in cloth
loom. 6 Volt. (02.726-
15)
\$35.00 EA

Clutch Head Screws



5932796A 47-54
With tin u-nuts, attach headlight bucket to
fender (32 pcs). (02.726-4)
\$12.50 SET

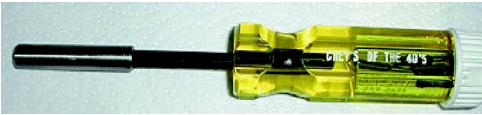
Returns require a return authorization number, please call.

90T: Headlight Components & Headlight Switches



Format = Part No., Year, Description, original Chevrolet Part Book Group No., Price and Unit Measure.

Clutch Head Driver W/ Bits



DRIVER ALL
Magnetic driver w/ 5 bits (1/8in., 5/32in., 3/16in., 1/4in., 5/16in.) with Chevs imprint. (08.821-15)
\$22.25 SET

Clutch Head Bits



3685598
1/8in. (1/4in. drive)
(08.821-3)
\$4.00 EA



3685592
5/32in. (1/4in. drive)
(08.821-4)
\$4.00 EA



3685594
3/16in. (1/4in. drive)
(08.821-3)
\$4.00 EA



3685593
1/4in. (1/4in. drive)
(08.821-3)
\$4.00 EA



3685595
5/16in. (1/4in. drive)
(08.821-2)
\$6.00 EA

Clutch Bit Holder



3685596
For your 1/4in. drive ratchet. Holds clutch head bits. (08.821-2)
\$6.00 EA

Headlight Bucket Spring



924551 41-46
Tension adjusting.
(02.721-4)
\$5.50 EA



5937452 47-54
Tension adjusting.
(02.721-3)
\$6.00 EA

Headlight Rim



921514..... 36-39
Chrome (36 car, 37-39 trucks exc COE). Does not come with tab or screw (02.728-15)
\$27.50 EA



5930416..... 40
Stainless repro.(02.728-15)
\$28.00 EA



924722..... 41-46
Chrome (02.728-15)
\$25.00 EA

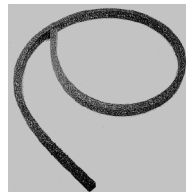


5941285..... 47-54
Door, w/ clips, stainless steel. (02.728-15)
\$15.00 EA



5941285A 47-54
Stainless, replacement w/ cutouts for adjustment screws (allows for adjustment w/out removing rim). (02.728-4)
\$10.00 EA

Headlight Lens Seal



605918..... 32-39
2 pcs (02.735-4)
\$5.50 EA

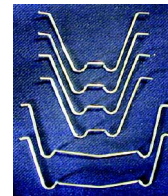


5930594A 40-54
Headlight rim to sealed beam retainer (02.735-3)
\$9.00 SET



5930594C 40-54
W/ wire insert headlight rim to retainer (02.735-4)
\$13.25 PR

Headlight Rim Seal Clip



5934791 37-39
Does 2. (02.746-4)
\$5.00 SET

5934791 40-54
Does 2. (02.746-15)
\$5.00 SET

Sealed Beam Retainer Ring



5930433..... 40
Stainless repro. (02.731-15)
\$14.00 EA



924534..... 41-54
(02.731-3)
\$14.75 EA

Screws-Sealed Beam Retainer Ring



924622 40-54
Retainer screws (3 pcs) (02.729-4)
\$2.00 SET

Terminal Boards



1865535 40-53
(3 terminal) main wiring to headlight & park light pigtailed w/ rivets. (02.560-3)
\$20.00 PR



1998756 40-54
(4 terminal) main wiring to headlight & park light pigtailed w/ rivets. (02.560-3)
\$24.00 PR

Note: Headlight bulbs see Section 100T.

90T

Providing part #'s speeds up your order, improves accuracy, and helps us maintain low prices.

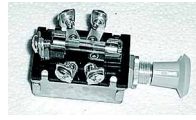
See Illustration Index for core charge information and a list of abbreviations. For Body Model information, see 5T. 73



90T: Headlight Components & Headlight Switches

Format = Part No., Year, Description, original Chevrolet Part Book Group No., Price and Unit Measure.

Headlight Switch



1995040.....**30-46**
Replacement
(02.485-4)
\$19.00 EA



1995040A.....**30-46**
Delco original
replacement, w/
removable shaft.
(02.485-15)
\$70.00 EA



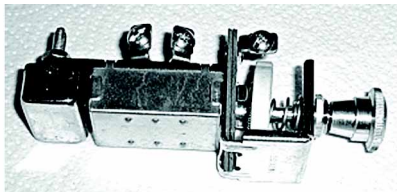
1994007.....**39**
Genuine Delco, NOS.
(02.485-15)
\$85.00 EA



1995041S.....**47-54**
6 Volt. Superior. Uses
original nut, knob &
removable shaft.
Includes spade
terminals (for units w/
locking groove at end of
shaft). (02.485-15)
\$40.00 EA



1995041T.....**47-54**
12 Volt. Superior. Uses
original nut, knob &
removable shaft.
Includes spade
terminals (for units w/
locking groove at end of
shaft). (02.485-15)
\$40.00 EA



1995041A.....**47-54**
Replacement, nonremovable shaft. 12volt.
(02.485-2)
\$19.50 EA



1995041R.....**47-54**
Superior. Uses original
nut, knob & removable
shaft. Includes spade
terminals (for use w/
units with locking
groove at end of shaft).
(02.485-3)
\$60.00 EA

Headlight Switch Shaft



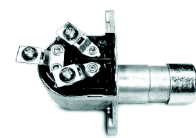
3653818S..... **47-54**
Removable type.
(02.485-4)
\$5.00 EA

Headlight Switch Retaining Nut



1995041C..... **47-54**
Stainless (02.485-15)
\$8.00 EA

Dimmer Switch



1997008..... **29-54**
(02.459-15)
\$9.00 EA

Headlight Relay



1116789A..... **37-54**
6v (02.485-15)
\$26.00 EA



1116789B..... **ALL**
12v (02.485-15)
\$40.00 EA

Odds & Ends

1997853.....**ALL**
Auxiliary lamp switch on-off (09.774-0)
\$40.00 EA
925203U..... **41-46**
Headlight assembly left. No park light
(Used) (02.725-0)
\$100.00 EA
925204U..... **41-46**
Headlight assembly right no park light
(Used) (02.725-0)
\$100.00 EA
5933136U..... **41-46**
Headlight bucket, right side (Used)
(00.000-0)
\$60.00 EA
193142N.....**ALL**
Headlight cover, NOS black with red plastic
jewel (02.731-0)
\$30.00 EA
1116789U..... **37-54**
Headlight Relay 6v used (02.485-0)
\$20.00 EA
350966U..... **39-40**
Headlight stand, right side (Used) (2.546-0)
\$60.00 EA
1995041U..... **47-54**
Headlight Switch (2.487-0)
\$95.00 EA
1995041..... **47-54**
Headlight Switch (2.487-0)
\$135.00 EA

Returns require a return authorization number, please call.

100T: Light Bulbs & Sealed Beams



Format = Part No., Year, Description, original Chevrolet Part Book Group No., Price and Unit Measure.

Street Rod Parts

Headlight - Halogen with LED Turn Signal. AutoNik Slick Signals



AUT6001C..... ALL
The ultimate in cool. 7 inch, H-4 Halogen sealed lens with amber LED turn signal-marker light. Replacement for H6024 sealed beam. Complete instructions and easy to install. Extensive testing went into bulb selection for long life and best lighting characteristics. (02.727-15)
\$180.00 PR

Headlight - Halo Halogen



110185HALO..... ALL
Sealed beam replacement. Used halogen bulb (not included). Choose blue or white halo. (00.000-15)
\$25.00 EA

Headlight - Halogen



T70300A..... 40-54
7" Clear glass w/ diamond cut reflector & Tri-Bar w/ blue-dot. Comes w/ H4 55/60 watt xenon filled bulb. (02.727-15)
\$100.00 EA



T70100A..... 40-54
7" Clear glass w/ diamond cut reflector. Comes w/ H4 55/60 watt xenon filled bulb. (02.727-15)
\$70.00 EA

Headlight - Halogen

110185TB.....
Sealed beam replacement w/ replaceable halogen bulb and Tri-Bar with interchangeable colored dots. (02.727-4)
\$126.00 EA



HAGLSE.....40-54
Halogen sealed 7 inch lamp. Comes with H-4 bulbs. (02.726-15)
\$175.00 PR



110185J..... 40-54
7in. crystal replacement glass. Curved lens with halogen H4/ HB2, 60/55 watt bulb. 12V, replaces H6017 or H6024. (02.727-15)
\$34.00 EA



HAGLBDT.....40-54
Blue Dot, halogen sealed 7 inch lamp. Comes with H-4 bulbs. (02.727-15)
\$175.00 PR



110185H..... 40-54
Sealed beam replacement w/ flat lens & replaceable halogen bulb, 6v. (02.727-15)
\$38.00 EA



5947212H..... 40-54
Sealed beam replacement w/ flat lens & replaceable halogen bulb, 12v. (02.727-2)
\$30.00 EA

Halogen Headlight Conversion-Bulb



110185C..... 31-39
Headlight bulb. Clear Halogen, 12v, H4 replacement. (08.991-4)
\$9.00 EA



110185B..... 31-39
Headlight bulb. Clear Halogen, 6v. (08.991-15)
\$18.00 EA



110185CB..... 31-39
Headlight bulb. Blue Halogen, 12v, H4 replacement. (08.991-2)
\$14.00 EA

Bulbs-Halogen



145416F..... ALL
Halogen tail light & park light w/ turn signal, 6v, dual filament, straight pin, replacement for #1158. (08.991-15)
\$15.00 EA



145416B..... ALL
Halogen tail light & park light w/ turn signal, 12v, dual filament, 55/5 watt, offset pin, replacement for #1157. (08.991-4)
\$11.50 EA



145416G..... ALL
Halogen tail light & park light w/ turn signal, 12v, dual filament, 55/5 watt, straight pins, replacement for #1156. (08.991-15)
\$15.00 EA



145416C..... ALL
Halogen tail light & park light, 6v 50 watt, single filament, straight pin. (08.991-4)
\$15.00 EA



145416D..... ALL
Halogen tail light & park light, 6v 20 watt, single filament, straight pin. (08.991-15)
\$15.00 EA

100T

Providing part #'s speeds up your order, improves accuracy, and helps us maintain low prices.

See Illustration Index for core charge information and a list of abbreviations. For Body Model information, see 5T. 75



100T: Light Bulbs & Sealed Beams

Format = Part No., Year, Description, original Chevrolet Part Book Group No., Price and Unit Measure.

Bulbs-Halogen



145416E..... ALL
Halogen tail light & park light w/ turn signal, 6v, dual filament, offset pin, replacement for #1154. (08.991-4)

\$14.00 EA



145416H ALL
Halogen tail light & park light, 12v 50 watt, single filament, straight pin. (08.991-4)

\$12.00 EA



145416I..... ALL
Halogen tail light & park light, 12v 20 watt, single filament, straight pin. (08.991-15)

\$12.00 EA

Bulbs-LED



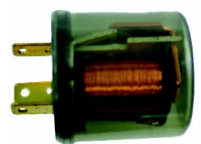
145416J..... ALL
LED super bright amber. Minimal current draw. 12v, replaces bulb #1157. Use LED flasher #3713382L. (08.991-15)

\$15.00 EA

145416K..... ALL
LED super bright amber. Minimal current draw. 12v, straight pin, replaces bulb #1156. Use LED flasher #3713382L. (08.991-15)

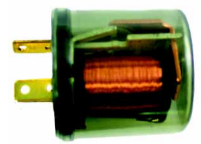
\$12.00 EA

Turn Signal Flasher-LED



3713382L..... ALL
12v. For use w/ LED lights (3 prong). (02.892-3)

\$16.25 EA



3713382L2..... ALL
12v. For use w/ LED lights (2 prong). (02.892-3)

\$16.25 EA



FF552NLF ALL
12v. For use w/ LED lights (2 prong). Fixed blinker speed. (02.892-15)

\$10.00 EA

Turn Signal Flasher-LED

FF552NL ALL
12v. For use w/ LED lights (2 prong). Adjustable blinker speed. (02.892-15)

\$40.00 EA

FF552NLP ALL
12v. For use w/ LED lights (2 prong). Adjustable pulsing blinker speed. (02.892-15)

\$50.00 EA

Restoration Parts

Bulbs



110185 31-39
Headlight bulb. 6 volt. (08.991-4)

\$12.00 EA

Headlight



193142 40-54
Sealed beam 6v. (02.727-15)

\$11.00 EA



5947212 ALL
Sealed beam 12v, headlight. (02.727-15)

\$4.25 EA

Bulbs



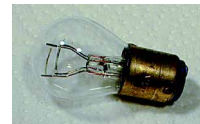
142303 ALL
Tail light or license light. Fits some Sedan Delivery tail lights. #63-6v. (08.991-2)

\$1.50 EA



145416 ALL
Tail light & stop light #1154-6v. (08.991-15)

\$1.75 EA



145416A..... ALL
Tail light & stop light (bright) #1157-12v w/ offset pins. (08.991-3)

\$1.00 EA

Bulbs



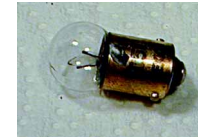
145417 ALL
Brake and turn signal. Dual element 6v w/ equal height retaining pins. #1158. (08.991-15)

\$4.00 EA



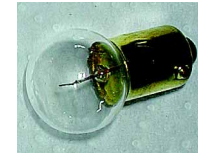
145419 ALL
Brake and turn signal. Dual element 12v w/ equal height retaining pins. #1176. (08.991-15)

\$3.00 EA



115273 ALL
High beam indicator & ignition lock lamp #51-6v. (08.991-15)

\$1.25 EA



125588 ALL
Parking (in head lamp) instrument panel, clock, glove box, dome light, Cabriolet tail light indicator #55-6v. (08.991-15)

\$1.50 EA



119434 ALL
Dome lamp #82-6v (2 contacts). (08.991-15)

\$2.00 EA



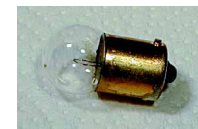
120406 ALL
Dome lamp #88-6v (2 contacts). (08.991-15)

\$6.50 EA



119294 ALL
Dome & stop lamp #87-6v (1 contact) w/ straight pins. (08.991-15)

\$2.50 EA



142306 ALL
Dome lamp (panel) #81-6v (1 contact). (08.991-15)

\$1.50 EA



142309 ALL
Fog, back up & safety light #1133-6v. (08.991-15)

\$3.50 EA

Returns require a return authorization number, please call.

100T: Light Bulbs & Sealed Beams



Format = Part No., Year, Description, original Chevrolet Part Book Group No., Price and Unit Measure.

Bulbs



179006ALL
Fog light #1007-6v.
(08.991-15)
\$18.00 EA



145431ALL
Safety light-spotlight
#1323-6v. (08.991-15)
\$11.00 EA

Spotlight



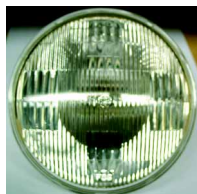
456720 ALL
6in. sealed beam, 12v, #4435. (09.773-2)
\$24.00 EA

444279 ALL
6in. sealed beam, 6v, #4535. (09.773-2)
\$28.00 EA

451927 ALL
5in. sealed beam, 12v, #4405 (fits unity
spotlight only). (09.773-15)
\$16.00 EA

987264 ALL
5in. sealed beam, 6v, #4515. (09.773-2)
\$32.75 EA

Driving Light



987263 ALL
6in. sealed beam. Clear, 12v, #4412.
(09.774-15)
\$16.00 EA

Driving Light



986942 ALL
6in. sealed beam. Clear, 6v, #4012.
(09.774-2)
\$21.00 EA

593837 ALL
5in. sealed beam. Clear, 12v, #4415.
(09.774-15)
\$16.00 EA

3936674 ALL
5in. sealed beam. Clear, 6v, #4015.
(09.774-2)
\$27.75 EA

Fog Light



987263A ALL
6in. sealed beam, amber, 12v, #4412A.
(09.774-15)
\$20.00 EA

986942A ALL
6in. sealed beam, amber, 6v, #4012A.
(09.774-2)
\$48.75 EA

593837A ALL
5in. sealed beam, amber, 12v, #4415A.
(09.774-3)
\$31.00 EA

3936674A ALL
5in. sealed beam, amber, 6v, #4015A.
(09.774-15)
\$36.00 EA

100T

Providing part #'s speeds up your order, improves accuracy, and helps us maintain low prices.

See Illustration Index for core charge information and a list of abbreviations. For Body Model information, see 5T. 77



110T: Tail lights, LED Lights, Flush Mount Kits, Blue Dots, License Lights, Backup Lights

Format = Part No., Year, Description, original Chevrolet Part Book Group No., Price and Unit Measure.

Street Rod Parts

Note: Tail light parts below fit Panels & Suburbans w/ 3in. O.D. round, bullet-shaped dual tail lights.

LED 1940-53 Tail Light Assembly



927074FL 40-53
Red LED tail light with stainless steel housing. White LED license light on bottom of housing. Left side. (02.679-15)
\$38.00 EA



927074HL 40-53
Red LED tail light with chrome housing. White LED license light on bottom of housing. Left side. (02.679-15)
\$38.00 EA



985608FR..... 40-53
Red LED tail light with stainless steel housing. Right hand side. (02.679-15)
\$32.00 EA



985608HR 40-53
Red LED tail light with chrome housing. Right hand side. (02.679-15)
\$32.00 EA



927074EL..... 40-53
Red LED tail light with black housing. White LED license light on bottom of housing. Left side. (02.679-0)
\$35.00 EA



985608ER 40-53
Red LED tail light with black housing. Right hand side. (02.679-15)
\$30.00 EA

1947-53 Tail Light Assembly



916877C..... 47-53
Chrome housing, red lens. (02.679-15)
\$80.00 EA

LED 1947-53 Tail Light Assembly



916877CLR..... 47-53
Chrome housing w/ Red lens. (02.679-15)
\$100.00 EA



916877CLRC .. 47-53
Chrome housing w/ Clear lens & Red LED. (02.679-15)
\$100.00 EA



916877LR..... 47-53
Primered housing w/ Red lens. (02.679-15)
\$95.00 EA



916877LRC..... 47-53
Primered housing w/ Red LED & clear lens. (02.679-15)
\$95.00 EA

LED Lens & Reflector



920696LRR..... 39-53
Lens & reflector. 3" tail light. RED. (02.682-15)
\$26.00 EA

LED Insert W/ Lens



920626LL 40-53
Direct replacement Red LED with white LED license light. Left side. (02.682-15)
\$39.75 EA



920626LR..... 40-53
Direct replacement Red LED. Right side. (02.682-15)
\$27.00 EA

Blue Dots



920626A..... ALL
W/ chrome ring (you install). (02.682-2)
\$6.00 PR



920627..... ALL
Chrome with colored Bowtie. Specify color: blue, amber, green, clear or red. Fits blue dot hole. (02.682-0)
\$22.00 PR



BIS62220 ALL
Oval billet aluminum 3rd brake light. Polished. 7in. wide x 1-3/4in. high x 1in. deep. (02.679-15)
\$50.00 EA

Returns require a return authorization number, please call.

110T: Tail lights, LED Lights, Flush Mount Kits, Blue Dots, License Lights, Backup Lights



Format = Part No., Year, Description, original Chevrolet Part Book Group No., Price and Unit Measure.

Restoration Parts

1934-39 Tail Light



916642 37-39
Complete unit. Glass lens, black housing (exc Panel & Suburban). (02.679-15)
\$67.25 EA



913823 34-39
Lens (02.682-2)
\$10.00 EA



913824 34-39
Gasket, lens. (02.684-15)
\$1.75 EA



913825 34-39
Rim. Chrome With Bowtie center. (02.681-0)
\$16.50 EA

1940-53 Tail Light



LED
927074GL 40-53
W/ script glass lens. Left side. (02.679-2)
\$27.50 EA

985608GR 40-53
W/ script glass lens. Right side. (02.679-2)
\$27.50 EA



927074L 40-53
W/ plastic lens. Left side. (02.679-15)
\$26.50 EA

1940-53 Tail Light

985608R 40-53
W/ plastic lens, right. (02.679-15)
\$26.50 EA

927074BL 40-53
W/ glass lens and blue dot. Left side. (02.679-2)
\$38.00 EA

985608BR 40-53
W/ glass lens & blue dot. Right side. (02.679-2)
\$38.00 EA

927074CL 40-53
Chrome w/ script glass lens. Left side. (02.679-15)
\$31.00 EA

985608CR 40-53
Chrome w/ script glass lens, right. (02.679-15)
\$31.00 EA

927074DL 40-53
Glass lens w/ blue dot and chrome housing. Left side. (02.679-15)
\$39.75 EA

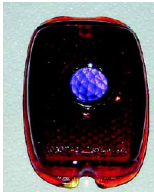
985608DR 40-53
Chrome, glass w/ blue dot. Right side. (02.679-15)
\$39.75 EA



5937162 40-53
Tail light lens, plastic, 4in. x 2-3/4in. (02.682-3)
\$6.75 EA



920626 40-53
Tail light lens. Original script, glass, 4in. x 2-3/4in. (02.682-3)
\$7.00 EA



920626B 40-53
Tail light lens. Glass w/ blue dot, 4in. x 2-3/4in. (02.682-2)
\$14.00 EA

1940-53 Tail Light



920625 40-53
Gasket, tail light lens, 4in. x 2-3/4in. (02.684-3)
\$1.75 EA



5933830 40-53
Tail light rim, 4in. x 2-3/4in. (02.681-15)
\$6.75 EA

1947-53 Tail Light Panel & Suburban (Optional Tail Lights)



916877 47-53
Primered housing, red lens. (02.679-15)
\$75.00 EA

Note: Tail light parts below fit Panels & Suburbans w/ 3in. O.D. round, bullet-shaped dual tail lights.



916877F 39-52
Housing. Fiberglass w/o inner bucket. 3in. round. Needs rim cutouts (fits '40-'52 Sedan Delivery). (02.679-15)
\$48.00 EA



923322 47-53
Rim (3in. round). (02.681-15)
\$20.00 EA



920696 47-53
Lens, glass (3in. round). (02.682-15)
\$9.00 EA

110T

Providing part #'s speeds up your order, improves accuracy, and helps us maintain low prices.

See Illustration Index for core charge information and a list of abbreviations. For Body Model information, see 5T. 79



110T: Tail lights, LED Lights, Flush Mount Kits, Blue Dots, License Lights, Backup Lights

Format = Part No., Year, Description, original Chevrolet Part Book Group No., Price and Unit Measure.

1947-53 Tail Light Panel & Suburban (Optional Tail Lights)



920696B.....47-53
Lens, glass (3in. round) w/ blue dot. (02.682-15)
\$15.00 EA



921872.....47-53
Gasket, lens (3in. o.d., round) (2 pcs). (02.684-4)
\$2.25 SET



916879.....47-53
Pad-for 3in. round tail lights (2 pcs) (02.660-15)
\$9.00 PR

Tail Light-Panel/ Suburban w/ Doors



5936906.....47-56
Lens (Panel, Suburban w/ doors). (02.682-3)
\$13.50 EA



5936906B.....47-56
Lens w/ blue dot (Panel, Suburban w/ doors). (02.682-15)
\$16.00 EA



5936907.....47-56
Gasket, lens (Panel, Suburban w/ doors). (02.684-2)
\$2.25 EA



5936905.....47-56
Gasket, license lens (Panel, Suburban w/ doors). (02.686-15)
\$1.50 EA



3676259.....47-56
Pad (Panel, Suburban w/ doors). (02.660-15)
\$31.25 EA

Tail Light -Panel/ Suburban w/ Tailgate

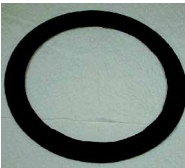


919351.....47-57
Lens & rim, 4-3/16in. o.d. round, (Panel, Suburban w/ tailgate), NOS. (02.682-3)
\$18.00 EA



919044.....47-57
Lens (Panel/ Suburban w/ tailgate) 4-3/16in. O.D., round. (02.682-15)
\$9.50 EA

Tail Light-Panel/ Suburban



3686479.....47-57
Pad, 4-1/2in. round, (Panel, Suburban w/ tailgate). (02.660-15)
\$22.75 EA

1954 Tail Light



897711.....54
Assembly. Black w/ boot & pigtail. (02.679-15)
\$34.00 EA



897711C.....54
Assembly. Stainless w/ boot & pigtail. (02.679-15)
\$40.00 EA



918355.....54
Rim stainless steel. (02.681-15)
\$6.50 EA



5938745.....54
Lens, plastic w/ guide script. (02.682-15)
\$6.00 EA



914301.....54
Gasket, lens. (02.684-15)
\$3.00 EA

Rubber Boot



5933167C.....54-57
For tail light pigtail. (02.596-15)
\$15.00 EA

Tail Light Pigtail



5291632.....54-57
With bulb contacts. (02.694-15)
\$7.00 EA

Tail Light Brackets



602534.....34-39
Left, tail light & license. (02.662-15)
\$26.00 EA



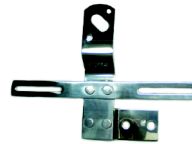
602535.....34-39
Right (02.662-15)
\$25.00 EA



604293.....40-46
Left, tail light & license. (02.662-15)
\$24.00 EA



604235.....40-46
Right (02.662-15)
\$23.00 EA



3847441S.....47-53
Left side, tail light & license plate mount. Stainless steel. (02.662-15)
\$19.00 EA



3696238S.....47-53
Right side. Stainless steel. (02.662-15)
\$19.00 EA



3847441E.....47-53
Left, tail light & license. (02.662-15)
\$9.00 EA



3847441D.....47-53
Left, tail light & license, chrome. (02.662-15)
\$14.00 EA



3696238E.....47-53
Right (02.662-15)
\$9.00 EA

Returns require a return authorization number, please call.

110T: Tail lights, LED Lights, Flush Mount Kits, Blue Dots, License Lights, Backup Lights



Format = Part No., Year, Description, original Chevrolet Part Book Group No., Price and Unit Measure.


Tail Light Brackets

-  **3696238D** 47-53
Right, chrome.
(02.662-15)
\$13.50 EA
-  **2301905S** 54
Left side. Stainless steel.
(02.662-15)
\$9.00 EA
-  **2034056S** 54
Right side. Stainless steel.
(02.662-15)
\$9.00 EA
-  **2309105** 54
Left, unpainted.
(02.662-15)
\$5.00 EA
-  **2304056** 54
Right, unpainted.
(02.662-15)
\$5.00 EA
-  **2309105C** 54
Left, chrome.
(02.662-15)
\$7.00 EA
-  **2304056C** 54
Right, chrome.
(02.662-15)
\$7.00 EA

1940-53 License Light Lens

-  **920634** 40-53
License light lens (glass). (02.685-15)
\$11.00 EA
-  **920634P** 40-53
License light lens (plastic). (02.685-2)
\$6.50 EA
-  **920808** 40-53
Gasket (02.686-4)
\$2.50 EA
-  **827925** 40-53
Retainer clips & screws, license light lens.
(02.691-15)
\$2.25 SET


1940-53 License Light Lens

-  **923315**..... 40-53
Screws for tail light rim. Stainless steel (2 pcs). (02.688-4)
\$0.75 SET


Switch

-  **924160**.....ALL
Fog light, backup light, etc, rotary. Clamps to dash bottom. (09.774-3)
\$20.00 EA

License Plate Bracket

-  **3707021**..... 54-59
Includes 12v license light rear. (02.705-3)
\$50.00 EA

License Light Pad

-  **3688071**..... 54
Pickup w/ rear bumper. (02.702-15)
\$6.75 PR

Back Up Light

-  **5935956**..... 50-52
Back up lens gasket (02.697-4)
\$3.50 SET
-  **5938297**..... 50-52
Lens, glass includes gasket #5935956 (02.697-2)
\$20.00 SET

Wire Conduit

- 985608SCL**40-53
19in. length, Stainless Steel line. (02.679-3)
\$8.00 EA
- 985608SCS**40-53
12in. length, Stainless Steel line. (02.679-15)
\$5.50 PR

Odds & Ends

Please call for availability on all Odds & Ends parts; once part is sold, it may no longer be in stock.

- 5539547U**..... 54-57
License light lens used (02.685-0)
\$10.00 EA
- 913823B** 31-35
Taillight Lens (glass) W/bowtie (02.682-0)
\$15.00 EA
- 920626U**..... 37-52
Lens-Tail Light (Glass) . (-0)
\$10.00 EA
- 3847313U**..... 47-53
Tail light Assy. Center. Fits Panel (10*000-0)
\$60.00 EA
- 04960** 55-57
Tail light Assy. Round lens w/ bracket (10*000-0)
\$35.00 EA

110T

Providing part #'s speeds up your order, improves accuracy, and helps us maintain low prices.

See Illustration Index for core charge information and a list of abbreviations. For Body Model information, see 5T. 81



120T: Fuel System (Gas Caps, Gas Tanks, Gas Tank Sending Units, Fuel Pumps, Carburetors & Intake Manifolds)

Format = Part No., Year, Description, original Chevrolet Part Book Group No., Price and Unit Measure.

Street Rod Parts

Gas Tank

Oversize shipping charges apply to all Gas Tanks. Please call for rate.

605240 **41-46**
Stainless steel w/ anti slosh baffle, 1/2Ton. Holds 24.5 gallons. (03.001-0)
\$695.00 EA

3692400 **47-53**
Stainless steel w/ anti slosh baffle. Fits 47-48 1/2T truck & 47-54 1/2T Panel. Holds 13.5 gallons. (03.001-15)
\$695.25 EA



605239 **ALL**
Steel w/ straps. Fits under bed. Universal mount. 27.75in. x 17.75in. x 8.5in. Holds 17.5 gallons. (03.001-0)
\$275.00 EA



605239C **ALL**
Top Fill Neck, die-stamped steel universal, under bed tank w/ straps. 3in. tall neck, billet cap (w/o ring). Baffled and vented. 23in. x 17in. x 10in. w/ 3/4in. flange around. 16 gallons. (03.001-15)
\$215.00 EA

Gas Tank



605239H **ALL**
Side Fill Neck, die-stamped steel universal, under bed tank. 2.5in. tall neck w/ 6in. hose. Baffled and vented. 23in. x 17in. x 10in. w/ 3/4in. flange around. 15 gallons. (03.001-15)
\$215.00 EA



605238 **ALL**
Polyethylene w/ straps. Fits under bed. Universal mount with 3in. neck. 22in. x 17in. x 9.5in. Holds 14 gallons. (03.001-0)
\$215.00 EA

Fuel Pump-Electric

High pressure In-Tank fuel pump kits. Adjustable from 7 inch to 10.5 inch deep. No welding required, components bolt together. Constructed with stainless steel reservoir tray, sealed electrical fitting, supply line, return line, vent fitting & In-Tank wiring harness. For use on tanks w/ internal baffle.

5591457B **37-51**
Fits steel tank-deluxe 190 liter per hour pump. 54 gph (gallons per hour) @ 50 psi; 32 gph @ 50 psi; 48 gph @ 60 psi. (03.900-0)
\$200.00 EA

5591457C **37-51**
Fits steel tank-high flow 250 liter per hour pump. 68 gph (gallons per hour) @ 50 psi; 65 gph @ 50 psi; 62 gph @ 60 psi. (03.900-0)
\$210.00 EA

5591457E **37-51**
Fits polyethylene tank-deluxe 190 liter per hour pump. 54 gph (gallons per hour) @ 50 psi; 32 gph @ 50 psi; 48 gph @ 60 psi. (03.900-0)
\$215.00 EA

Fuel Pump-Electric

5591457F **37-51**
Fits polyethylene tank-high flow 250 liter per hour pump. 68 gph (gallons per hour) @ 50 psi; 65 gph @ 50 psi; 62 gph @ 60 psi. (03.900-0)
\$225.00 EA

5592626E **ALL**
Inline, 12 volt. (30 GPH, 4-6 PSI) (03.900-15)
\$60.00 EA

5592627E **ALL**
Inline, 6 volt. (30 GPH, 4-6 PSI) (03.900-15)
\$60.00 EA

Fenton Intake 2 Carb



3836071E **50-62**
2 carb intake kit. Includes linkage and fuel kit to install from existing fuel line. For 235ci & 261ci (261ci uses 235ci carbs, w/ 2-15/16" bolt spacing). No grinding required to fit headers. (03.265-15)
\$200.00 EA

Fenton Intake



3687540B **50-62**
Install kit. Includes bellcrank, throttle rod & spring (03.579-15)
\$40.00 EA

Fenton Heat Kit



838573B **All**
Header to Fenton dual intake. (03.640-15)
\$40.00 EA

Returns require a return authorization number, please call.

120T: Fuel System (Gas Caps, Gas Tanks, Gas Tank Sending Units, Fuel Pumps, Carburetors & Intake Manifolds)



Format = Part No., Year, Description, original Chevrolet Part Book Group No., Price and Unit Measure.

Offenhauser Intake 2 Carb



3836071B.....37-53
Dual carb. Fits 216ci. Uses 216ci carbs with 2-5/8in. bolt spacing. Linkage included (03.265-15)

\$222.50 SET

3836071A.....50-62
Dual carb. Fits 235ci. 261ci uses 235ci carbs with 2-15/16in. bolt spacing. Linkage included (03.265-15)

\$222.50 SET

Offenhauser Intake 3 Carb



3836071D.....37-53
Triple carb. Fits 216ci. Uses 216ci carbs with 2-5/8in. bolt spacing. Linkage included (verify firewall clearance!) (03.265-0)

\$222.50 SET

3836071C.....50-62
Triple carb. Fits 235ci. 261ci uses 235ci carbs with 2-15/16in. bolt spacing. Linkage included (verify firewall clearance!) (03.265-0)

\$222.50 SET

Air Cleaner Assembly



1528725SALL
Smooth. Complete w/ 4in. filter and base clamp. (03.410-15)
\$10.00 EA



1528725LALL
Louvered. Complete w/ 4in. filter and base clamp. (03.410-15)
\$10.00 EA

Air Cleaner Assembly



1528725MS
Complete with 4in. filter, base clamp & 3 prong spinner. Smooth housing. 2-5/8in. neck. (03.410-15)

\$13.00 EA



1528725ML
Complete with 4in. filter, chrome louvered housing, base clamp & 3 prong spinner. Smooth housing. 2-5/8in. neck. (03.410-15)

\$13.00 EA

Adapter-Air Cleaner



1528725AALL
2-5/8in. to 2-5/16in to fit air cleaners. For use with mushroom air cleaners. (03.410-15)

\$1.00 EA

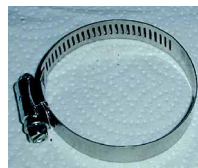
Air Filter Element



1528725EALL
4in. replacement for air cleaner assemblies (#1528725S & #1528725L) (03.410-15)

\$3.50 EA

Clamp-Air Cleaner

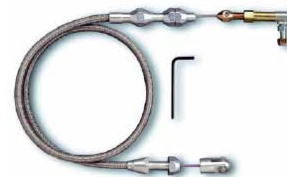


1528725CALL
Replacement for base of 4in. air cleaner (#1528725S & #1528725L) (03.410-4)

\$1.00 EA

Throttle Cables (Lokar)

Lokar cables are designed with a specially extruded liner for extended life of the cable. Cables are equipped with aluminum fitting and aluminum ferrule to eliminate fraying. Adapts to factory and aftermarket pedals.

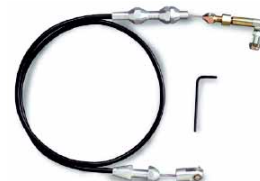


TC-1000HT ALL
Hi-Tech. 24in. w/ braided stainless steel sleeve. (03.450-15)

\$42.50 EA

TC-1000HT36 ALL
Hi-Tech. 36in. w/ braided stainless steel sleeve. (03.450-15)

\$48.00 EA



TC-1000U ALL
Universal. 24in. w/ black sleeve (03.450-15)

\$35.75 EA

TC-1000U36 ALL
Universal. 36in. w/ black sleeve (03.450-15)

\$41.50 EA



TC-1000TP..... ALL
For Tuned port inject. Hi-Tech, 24in. braided stainless steel sleeve. (03.450-15)

\$42.50 EA

120T

Providing part #'s speeds up your order, improves accuracy, and helps us maintain low prices.

See Illustration Index for core charge information and a list of abbreviations. For Body Model information, see 5T.



120T: Fuel System (Gas Caps, Gas Tanks, Gas Tank Sending Units, Fuel Pumps, Carburetors & Intake Manifolds)

Format = Part No., Year, Description, original Chevrolet Part Book Group No., Price and Unit Measure.

Line Clamp

Lokar Line Clamps are stainless steel and come with machine and sheetmetal screws. For securing electric, brake, fuel or transmission lines.



- 13274 ALL 3/16in. single (12 clamps). (08.950-15).....\$17.00 SET
- 13277 ALL 1/4in. single (12 clamps)... (08.950-15).....\$17.00 SET
- 13278 ALL 5/16in. single (12 clamps). (08.950-15).....\$17.00 SET
- 13279 ALL 3/8in. single (12 clamps)... (08.950-15).....\$17.00 SET
- 13280 ALL 1/2in. single (12 clamps)... (08.950-15).....\$17.00 SET
- 13281 ALL 5/8in. single (8 clamps)..... (08.950-15).....\$17.00 SET
- 13282 ALL 3/4in. single (8 clamps). (08.950-15).....\$17.00 SET
- 13283 ALL 7/8in. single (8 clamps). (08.950-15).....\$17.00 SET



- 13276 ALL 3/16in. x 3/16in. double (6 clamps). (08.950-15).....\$17.00 SET
- 13285 ALL 1/4in. x 1/4in. double (6 clamps). (08.950-15).....\$17.00 SET
- 13286 ALL 5/16in. x 5/16in. double (6 clamps). (08.950-15).....\$17.00 SET
- 13287 ALL 3/8in. x 3/8in. double (6 clamps). (08.950-15).....\$17.00 SET
- 13288 ALL 1/2in. x 1/2in. double (6 clamps). (08.950-15).....\$17.00 SET
- 13289 ALL 5/8in. x 5/8in. double (4 clamps). (08.950-15).....\$17.00 SET
- 13290 ALL 3/4in. x 3/4in. double (4 clamps). (08.950-15).....\$17.00 SET
- 13291 ALL 7/8in. x 7/8in. double (4 clamps). (08.950-15).....\$17.00 SET

Line Clamp



- 13275 ALL 3/16in. x 3/8in. combination (6 clamps).(08.950-15).... \$17.00 SET
- 13284 ALL 5/16in. x 3/8in. combination (6 clamps).(08.950-15).... \$17.00 SET

Clamp



120521 ALL
1/4in. bolt-on strap. For wire or tube (4 pcs). (08.950-4)

\$2.50 SET



120521B ALL
3/8in. bolt-on strap. For wire or tube (4 pcs). (08.950-4)

\$2.50 SET

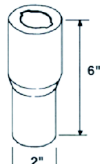


120521A ALL
5/16in, insulated bolt-on strap. For wire or tube (4 pcs) (08.950-4)

\$2.50 SET

Gas Tank Filler Flange

2-1/2" dia.



3658523S ALL
Stainless steel filler neck accepts locking or stock gas caps. 6 inch length, fits 2 inch I.D. hose. (03.003-0)

\$85.00 EA

Fuel Fill Bowl



Flush mount one-piece bowl

605238A ALL
Flush bed mount, stainless fuel fill bowl for under bed gas tank (03.001-0)

\$22.00 EA

Grommet-Fuel Fill Bowl

605238C ALL
For flush bed mounted fuel fill bowl (03.001-0)
\$5.00 EA

Restoration Parts

Gas Tank

Oversize shipping charges apply to all Gas Tanks. Please call for rate.



3708971..... 49-54
Behind seat, galvanized (like original). Holds 17.0 gallons. (03.001-15)
\$157.00 EA

Tank Straps



3658213A..... ALL
Universal, no hardware included. (03.022-15)
\$16.00 PR

Gas Tank Mounting Bracket



3690133B 49-55
With straps. (03.022-15)
\$70.00 PR

Gas Tank Mounting Pad



3690131 39-46
Gas tank (4 pcs). (03.015-15)
\$10.00 SET



3690131B..... 47-54
Gas tank bumper & grommet kit (8 pcs). (03.015-15)
\$15.00 SET

Returns require a return authorization number, please call.

120T: Fuel System (Gas Caps, Gas Tanks, Gas Tank Sending Units, Fuel Pumps, Carburetors & Intake Manifolds)



Format = Part No., Year, Description, original Chevrolet Part Book Group No., Price and Unit Measure.

Gas Tank Fill Hose Kit



3684410 49-57
Kit comes complete with hoses, clamps, neck, cap & grommet. (03.003-15)
\$60.00 SET

Gas Cap



985076A 37-57
Locking with Bowtie. Inside flange. (03.028-15)
\$40.00 EA



595857 28-57
Nonlocking, polished stainless steel like original, w/ inside flange (03.028-0)
\$7.50 EA



595857L 28-52
Locking, chrome w/ inside flange. Not original item. (03.028-15)
\$8.00 EA

Grommet-Gas Filler



3800461 39-46
Panel & Suburban. (03.008-15)
\$11.50 EA



598847 38-46
Rubber. 42- 46 also use pad #3674211 (below). (03.008-15)
\$10.00 EA



3674211 42-46
Flange, held by 4 screws & metal retainer. Use with grommet #598847 (above). (03.008-15)
\$10.00 EA



3606433 47-48
(03.008-15)
\$7.50 EA

Grommet-Gas Filler



3807278..... 47-54
Panel & Suburban. (03.008-2)
\$9.00 EA



3807281..... 49-54
(03.008-3)
\$8.50 EA

Hose-Gas Tank Filler

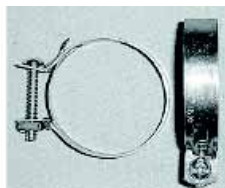


3654570 37-48
GM script with clamps exc COE. (03.003-3)
\$10.25 SET

3654570 49-57
GM script with clamps (panel, suburban & school bus chassis). (03.003-3)
\$10.25 SET

3692531 49-57
& vent hose GM script w/ clamps (conventional cab). (03.003-4)
\$9.00 SET

Clamp-Gas Filler Hose



111619 49-57
For 1-3/8in. i.d. gas filler hose. Original, conventional cab (2 pcs). (01.166-4)
\$2.50 SET

3834073B..... 37-57
For 2-1/4in. i.d. gas filler hose, original. Fits Panel, Suburban, Bus & 37-46 exc COE (2 pcs). (03.003-4)
\$4.00 SET

Fuel Stabilizer

Keep fuel fresh. Removes water, cleans carburetors & fuel injectors. Protects engine from gum, varnish, rust, and corrosion. Eliminates need to drain fuel before storage. Special dispenser bottles measure exactly without waste. Contains NO alcohol.



111801B ALL
POR-15 stabilizer. Treats up to 48 gals (3 ozs. per gal). 1 pint. Treats for a minimum 2 years. (03.001-15)
\$11.25 EA



111801 ALL
STA-BIL stabilizer. 8 oz bottle treats 20 gallons. Treats up to 1 year (03.001-15)
\$7.25 EA

Gas Tank Restoration Kit



PORTANK ALL
Restore and maintain gummed up tanks. Cleaner, metal prep, sealer, fuel preservative/ stabilizer and complete instructions. (03.001-15)
\$65.00 EA

Metal Prep



PORMETAL..... ALL
Water based, OSHA approved biodegradable solution. 1 quart. (03.001-15)
\$15.75 EA

120T

Providing part #'s speeds up your order, improves accuracy, and helps us maintain low prices.

See Illustration Index for core charge information and a list of abbreviations. For Body Model information, see 5T.



120T: Fuel System (Gas Caps, Gas Tanks, Gas Tank Sending Units, Fuel Pumps, Carburetors & Intake Manifolds)

Format = Part No., Year, Description, original Chevrolet Part Book Group No., Price and Unit Measure.

Gas Tank Cleaner



PORCLEAN..... ALL
1 quart. (03.001-15)
\$10.50 EA

Gas Tank Sealer

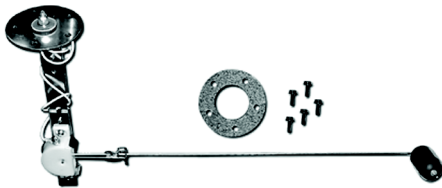


3657942B..... ALL
Seals gas tank.
Recommended for new tanks. Impervious to all fuels. (03.001-15)
\$32.75 QT



3657942C..... ALL
Seals gas tank. Alcohol resistant.
Recommended for new tanks. (03.001-15)
\$24.25 QT

Gas Tank Sending Unit



1516250 37-53
For gas gauge. Comes w/ screws, gasket & instructions. Correct ohms for Chev gauges (6v or 12v). (03.107-3)
\$50.00 EA

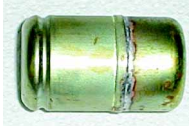
1517500 54-55
Correct ohms for Chev gauges (6v or 12v). Brass float. Will fit 47-53 w/ modifications. (03.107-15)
\$40.00 EA

Voltage Reducer



1119004..... ALL
12v conversion. Best for fuel gauge. Hi-Tech w/ constant volts (02.500-15)
\$18.00 EA

Float



3708954 47-59
Brass, for gas tank sending unit. (03.107-3)
\$7.50 EA



1516250A..... ALL
Cork, for gas tank sending unit. (03.107-4)
\$6.00 SET

Terminal Boot



1516252 ALL
Sending unit wire boot. (03.107-15)
\$14.25 EA

Gasket-Gas Tank Sending Unit



1516061 31-54
Gasket, gas tank sending unit (03.112-3)
\$2.00 EA

Screws (Brass)



1516061A..... ALL
Screws for sending unit (brass) (03.112-4)
\$4.00 SET

Grommet-Gas Gauge Wire



3653742 51-54
Gas gauge wire, 1/8in. I.D. X 1in. O.D. (09.775-15)
\$4.50 EA

Fuel Filter



986640AC..... 33-56
Genuine AC. Complete assembly w/ glass bowl & filter. (03.890-15)
\$29.00 EA



986640 33-56
Complete assembly w/ glass bowl and filter. (03.890-15)
\$18.00 EA

Fuel Filter



5451937 33-56
Replacement element (not for fuel pump filter). (03.890-15)
\$6.75 EA

Gasket-In Line Filter Bowl



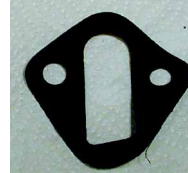
5452822 37-57
Gasket, inline filter bowl (03.890-2)
\$2.00 EA

Gasket-Fuel Pump



5590039 37-56
Fuel pump filter bowl gasket, 2-1/4in. o.d. (03.904-3)
\$2.00 EA

Mounting Gasket-Fuel Pump



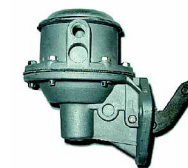
838263 37-57
Fuel pump mounting gasket (03.932-3)
\$1.50 EA

Glass Bowl



1523094 37-55
Fuel pump (1-15/16in. i.d.) w/ gasket (03.903-2)
\$8.75 SET

Fuel Pump



5592627 37-51
W/ metal bowl (03.900-0)
\$36.00 EA



1523429 37-51
W/ glass bowl (03.900-15)
\$55.00 EA

Returns require a return authorization number, please call.

120T: Fuel System (Gas Caps, Gas Tanks, Gas Tank Sending Units, Fuel Pumps, Carburetors & Intake Manifolds)

Format = Part No., Year, Description, original Chevrolet Part Book Group No., Price and Unit Measure.



Fuel Pump



5591457 37-51
W/ vacuum pump (glass bowl) stops slow wipers, original accessory. Also fits GMC. (03.900-15)
\$96.00 EA



5591457M..... 37-51
W/ vacuum pump (metal bowl) (03.900-15)
\$63.00 EA



5592627M..... 52-57
W/ metal bowl (03.900-15)
\$45.00 EA



5592627G 52-57
W/ glass bowl (03.900-15)
\$55.00 EA



5592675M..... 52-57
W/ vacuum pump (metal bowl) stops slow wipers, original accessory. (03.900-15)
\$72.00 EA



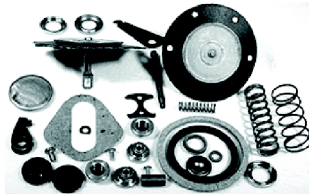
5592675 52-57
W/ vacuum pump (glass bowl) stops slow wipers, original accessory. (03.900-15)
\$86.00 EA

Fuel Pump Rebuild Kit

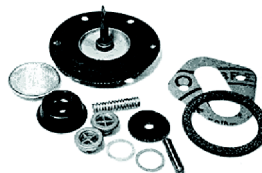


5592945 37-51
Without vacuum pump (03.901-15)
\$32.00 EA

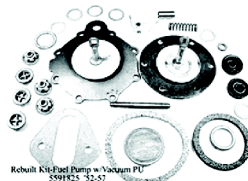
Fuel Pump Rebuild Kit



5591844 37-51
W/ vacuum pump (03.901-15)
\$53.75 EA



5592988 52-57
Without vacuum pump (03.901-15)
\$30.00 EA



5591825 52-57
W/ vacuum pump (03.900-15)
\$39.50 EA

Air Filter Element



1529264..... 37-54
Complete (03.410-15)
\$27.00 EA

Note: Air Filter Decals see Section 550T.

Air Filter



1529264A 37-54
Copper mesh only. (03.410-15)
\$10.00 EA

Wing Nut



120240..... 37-54
Air filter wing nut (08.920-4)
\$1.25 EA

Carburetor

Note: All Carburetors are rebuilt units.



838938 37-40
Carter W-1 (\$100 core) (03.725-2)
\$160.00 EA



839987 41-48
Carter W-1 (\$100 core) (03.725-2)
\$160.00 EA



3692429C 49
Carter W-1 (\$100 core) (03.725-2)
\$160.00 EA



7004600 49-53
Rochester. Fits 216ci (\$100 core) (03.725-2)
\$152.00 EA



7004468 50-59
Rochester. Fits 235ci (\$100 core). (03.725-2)
\$152.00 EA

Carburetor Rebuild Kit



7004363 32-62
Rochester (03.725-2)
\$19.25 EA



3902169C 37-56
Fits Carter Y-F, 216ci (03.725-15)
\$23.00 EA



603978 36-40
Fits Carter W-1, 216ci engine (03.725-15)
\$52.75 EA

120T

Providing part #'s speeds up your order, improves accuracy, and helps us maintain low prices.

See Illustration Index for core charge information and a list of abbreviations. For Body Model information, see 5T.



120T: Fuel System (Gas Caps, Gas Tanks, Gas Tank Sending Units, Fuel Pumps, Carburetors & Intake Manifolds)

Format = Part No., Year, Description, original Chevrolet Part Book Group No., Price and Unit Measure.

Carburetor Rebuild Kit

 **609993** **41-48**
Carter W-1 (216ci)
(03.725-15)
\$53.75 EA

 **3692429** **49**
Carter W-1 (03.725-15)
\$53.75 EA

Carburetor Insulator



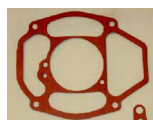
3692797 **34-53**
Bakelite exc 50-53 235ci (03.726-2)
\$13.25 EA

3692799 **50-59**
Bakelite (235ci) (03.726-2)
\$13.50 EA

3692797 **39-55**
Bakelite insulator (GMC). (03.726-2)
\$13.25 EA

Carburetor Base Gasket

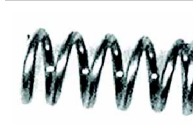
 **601348** **34-49**
(03.726-15)
\$1.50 EA


 **7002377** **49-50**
Rochester 3pc set,
NORS (03.725-0)
\$3.00 SET

 **839632** **50-53**
216ci engine. 2-3/4inch
bolt centers.
(03.726-15)
\$2.75 EA


 **3712549** **50-62**
Carburetor base (235ci,
261ci engine). 3inch
bolt centers.
(03.726-15)
\$2.25 EA


Carburetor Parts

 **837066** **32-49**
Spring for idle mixture
screw. Fits Carter W-1
(03.725-3)
\$0.75 EA


 **836639** **32-49**
Float level pin, Carter
W-1 (03.725-15)
\$0.25 EA


 **7002672** **37-57**
Carburetor float all w/
Rochester (03.745-15)
\$11.00 EA

 **601427** **38-49**
Needle & seat, Carter
exc DD, COE
(03.814-0)
\$4.75 EA

 **839528** **41-48**
Accelerator pump
plunger, Carter W-1
(03.725-15)
\$14.00 EA

Carburetor Cleaner

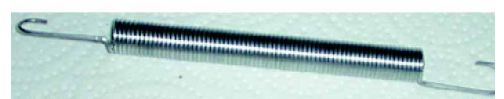
 **6505259** **ALL**
16 oz spray can
(03.725-15)
\$3.00 EA


 **12910** **ALL**
Carburetor renew,
bronze (5 oz. spray can)
(08.000-15)
\$15.50 EA

 **12911** **ALL**
Carburetor renew, silver
(5 oz. spray can)
(08.000-15)
\$15.50 EA

Throttle Return Spring

 **3650230** **37-40**
(03.459-15)
\$4.50 EA

 **3659431** **41-49**
(03.459-15)
\$4.00 EA

 **3695705** **50-59**
All 6 cylinder. (03.459-15)
\$4.00 EA

Main Fuel Line

348753 **ALL**
Steel (specify year when ordering).
(08.964-15)
\$60.00 SET

348753S **ALL**
Stainless (specify year when ordering).
(08.964-15)
\$85.00 SET

Oversize shipping charges apply.
Please call for rate.

Fuel Pump to Carb Fuel Line

348754 **ALL**
Steel (specify year when ordering).
(08.964-15)
\$20.00 SET

348754S **ALL**
Stainless (specify year when ordering).
(08.964-15)
\$25.00 SET

Oversize shipping charges apply.
Please call for rate.

Returns require a return authorization number, please call.

120T: Fuel System (Gas Caps, Gas Tanks, Gas Tank Sending Units, Fuel Pumps, Carburetors & Intake Manifolds)



Format = Part No., Year, Description, original Chevrolet Part Book Group No., Price and Unit Measure.

Vacuum Advance Line

217278 **ALL**
Carb to distributor. Steel (specify year when ordering). (08.964-15)

\$20.00 SET

217278S **ALL**
Carb to distributor. Stainless (specify year when ordering). (08.964-15)

\$25.00 SET

Oversize shipping charges apply. Please call for rate.

Clip



599119 **ALL**
Holds gas & vacuum lines together, fuel pump to carburetor (uses 4) (08.950-2)

\$8.75 PR



3735074C **ALL**
3/8in. slot, gas, brake line, wire harness (4 pcs). (08.950-4)

\$4.00 SET



148129A **ALL**
Double ended, holds 1/4in. brake & 5/16in. gas line to frame (snaps into hole). (08.950-4)

\$3.00 EA

Gasket-Manifold



602483A **37-53**
Intake & exhaust manifold. Fits 216ci (3pcs) (03.270 -15)

\$11.00 SET

3707045 **50-58**
Intake & exhaust manifold. Fits 235ci & 261ci (3pcs) (03.270-15)

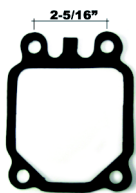
\$11.00 SET



838290 **37-53**
Rectangle between manifolds. Fits 216ci (03.272-15)

\$4.00 EA

Gasket-Manifold



3835572 **50-62**
Rectangle between manifolds. Fits 235ci & 261ci (03.272-15)

\$4.00 EA

Sleeves-(Metal)



837273 **39-53**
Intake to head 216ci. Exc 50-53 235ci (3 piece set) (03.281-15)

\$6.50 SET

3835506 **50-62**
Intake to head 235ci, 261ci (3 piece set) (03.281-15)

\$6.75 SET

Odds & Ends

Please call for availability on all Odds & Ends parts; once part is sold, it may no longer be in stock.

8560 **41-46**
Accy. vari-Speed Governor (11-0)

\$20.00 EA

7002890 **50-51**
Carb Float Bowl, 235ci Rochester (NOS) (03.724-0)

\$25.00 EA

5160 **49**
Carburetor, Carter We w/ Auto Choke (03.724-0)

\$195.00 EA

5280 **50-53**
Carburetor, Carter Y-F. For 216ci engine (03.725-0)

\$175.00 EA

700408S **54-57**
Carburetor Kit - 6 Cyl w/ H.T. (03.724-0)

\$15.00 EA

907 **41-62**
Contact Lever Floating Arm (Points) (3-0)

\$4.00 EA

5591843 **42-51**
Diaphragm kit. Fuel side, dual pump (11-0)

\$25.00 EA

Odds & Ends

5592876 **52**
Diaphragm rebuild kit (NORS). Use w/ part #559226 (11-0)

\$15.00 EA

5592877 **52-55**
Diaphragm rebuild kit (NORS). Use w/ part #5592627 (11-0)

\$15.00 EA

5592922 **52-55**
Diaphragm rebuild kit (NORS). Use w/ part #5592765 (11-0)

\$15.00 EA

1573094U **37-55**
Fuel pump glass bowl used (03.903-0)

\$10.00 EA

106 **35-55**
Fuel Pump Line To Carb (6 Cyl) NORS (11-0)

\$5.00 EA

5591547 **42-51**
Fuel & Vacuum Pump (NOS) (3.900-0)

\$90.00 EA

986640U **33-56**
Gas filter assembly (Used). (03.890-0)

\$10.00 EA

593306 **34-58**
Gas Lines NORS 7in. long (8.964-4)

\$15.00 EA

3835527 **37-53**
Intake manifold with oil filter. Fits 216ci. (03.265-0)

\$150.00 EA

3835881 **37-53**
Intake & exhaust manifold. Fits 216ci. (03.601-0)

\$175.00 EA

839577 **41-49**
Metering Rod- Carter W-1 (03.725-15)

\$2.50 EA

837368 **32-49**
Screw- Idle Mixture Carter W-1 (03.725-15)

\$2.00 EA

120T

Providing part #'s speeds up your order, improves accuracy, and helps us maintain low prices.

See Illustration Index for core charge information and a list of abbreviations. For Body Model information, see 5T.



130T: Exhaust System

Format = Part No., Year, Description, original Chevrolet Part Book Group No., Price and Unit Measure.

SANDERSON HEADERS

Small Block Engine

Part #	Year	Type	Steering/Suspension	Head	Price	Price
365790CC2 *	ALL	Tube	Stock (exc. 30-46) R&P or CS (Exc. 49-54)	SP or AP SP or AP	\$225.00	Jet Hot Coated \$375.00
365797CC3	ALL	Tube	R&P or CS (Exc. 30-46) 70-92 Camaro Clip	SP or AP SP or AP	225.00	375.00
365794CC1	ALL	Tube	67-79 Camaro Clip	SP	175.00	325.00
365795AP	ALL	Tube	67-79 Camaro Clip	AP	225.00	375.00
365795HO	ALL	Tube	67-79 Camaro Clip	HO	225.00	375.00
365796QP	ALL	Cast	R&P or CS 67-79 Camaro Clip	SP, AP, HO (Chevy heads only) SP, AP, HO (Chevy heads only)	320.00	480.00
365793QP	ALL	Cast	70-92 Camaro Clip	SP, AP, HO (Chevy heads only)	350.00	510.00

Big Block Engine

Part #	Year	Type	Steering/Suspension	Head	Price	Price
365783BB1	ALL	Tube	R&P or CS	Stock	\$265.00	Jet Hot Coated \$415.00
365785BB2	ALL	Tube	67-92 Camaro Clip	Stock	315.00	465.00
365787QP	ALL	Cast	R&P or CS 67-92 Camaro Clip	Stock	450.00	610.00
					450.00	610.00

R&P-Rack & Pinion Steering CS-Cross Steering (Drag link is parallel to tie rod [Vega Style Steering Box])

SP-Straight Plug AP-Angle Plug HO-High Output



365795HO ALL



365790CC2 ALL



365797CC3 ALL



365795AP ALL



365796 QP ALL
365796 QP ALL
365796 QP ALL



365783BB1 ALL
365785BB2 ALL



365794CC1 ALL

Returns require a return authorization number, please call.

130T: Exhaust System



Format = Part No., Year, Description, original Chevrolet Part Book Group No., Price and Unit Measure.

Street Rod Parts

Fenton Headers

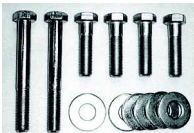


3657963A..... 37-62
Cast iron being reproduced under license from Fenton for all 1937-62 216ci, 235ci & 261ci engines. Wow! Comes with header flange and gaskets. (03.609-15)

\$260.00 PR

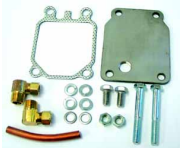
3657963G..... 37-62
Cast iron (GMC) being reproduced under license from Fenton for all 228in. , 247in. , 270in. & 302in. engines. Wow! Comes with header flange and gaskets. (03.609-15)

\$260.00 PR



3657963S..... 37-62
Bolt set for Fenton headers. (03.609-4)
\$4.00 SET

Fenton Heat Kit



838573B
Heat kit. Header to Fenton dual intake. (03.640-15)
\$40.00 EA

Tube Headers

Tube Headers
Tubing is mandrel bent to provide the highest flow possible, and fixture welded to ensure precise fit. Mounting flanges are O-ringed to reduce leakage.



3657963T..... 37-62
Black painted finish. Includes weld-on header pipe flanges. Fits 216ci or 235ci. (03.609-15)

\$132.00 SET

3657963TC..... 37-62
Ceramic coated finish. Includes weld-on header pipe flanges. Fits 216ci or 235ci. (03.609-15)

\$220.00 SET

Tube Headers



3657963SS..... 37-62
Polished stainless finish. Includes weld-on header pipe flanges. Fits 216ci or 235ci. (03.609-15)

\$180.00 SET



130T

Providing part #'s speeds up your order, improves accuracy, and helps us maintain low prices.

See Illustration Index for core charge information and a list of abbreviations. For Body Model information, see 5T. 91



130T: Exhaust System

Format = Part No., Year, Description, original Chevrolet Part Book Group No., Price and Unit Measure.

Restoration Parts

Exhaust System

Note: Complete system includes header pipe gasket, studs and nuts, header pipe spring (1938-42), header pipe, muffler, muffler clamps, muffler hanger, tailpipe, and tailpipe hanger as needed. Will not fit GMC.

Note: All pipes are aluminized at no extra charge.



599415B	37-40	1/2T	(03.705-15)	\$186.00	EA
599397B	37-40	3/4T	(03.705-15)	\$186.00	EA
3656764B	41-46	1/2T	(03.705-15)	\$186.00	EA
3657135B	41-48	3/4T	(03.705-15)	\$175.00	EA
3656962B	41-48	1-1/2T w/ 134-1/2in. wheelbase.	(03.705-15)	\$175.00	EA
3683656B	47-48	1/2T	(03.705-15)	\$186.00	EA
3683656C		1/2T	(03.705-15)	\$186.00	EA
3657135C		3/4T	(03.705-15)	\$171.50	EA
3656962C		1-1/2T w/ 134-1/2in. wheelbase.	(03.705-15)	\$161.50	EA
3696806A	50-53	1/2T	(03.705-15)	\$221.00	EA
3696161A	50-53	3/4T exc double duty.....	(03.705-15)	\$221.00	EA
3715243A	50-53	1T.....	(03.705-15)	\$221.00	EA
3692828A	50-53	1-1/2T& 2T 216ci.....	(03.705-15)	\$177.00	EA
3692828B	50-54	1-1/2T& 2T 235ci.....	(03.705-15)	\$177.00	EA
3696806B		1/2T	(03.705-15)	\$213.00	EA
3696161B		3/4T exc double duty.....	(03.705-15)	\$213.00	EA
3715243B		1T.....	(03.705-15)	\$213.00	EA

Oversize shipping charges apply to all Exhaust Systems. Please call for rate.

Gasket-Manifold

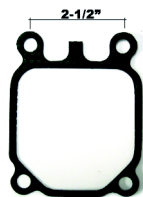


602483A.....37-53
Intake & exhaust manifold. Fits 216ci (3pcs) (03.270 -15)
\$11.00 SET

Gasket-Manifold

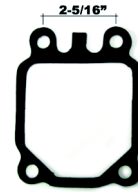


3707045.....50-58
Intake & exhaust manifold. Fits 235ci & 261ci (3pcs) (03.270-15)
\$11.00 SET



838290..... 37-53
Rectangle between manifolds. Fits 216ci (03.272-15)
\$4.00 EA

Gasket-Manifold



3835572..... 50-62
Rectangle between manifolds. Fits 235ci & 261ci (03.272-15)
\$4.00 EA

Studs In Manifold

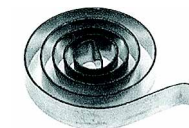


837552B..... 29-54
For header pipe, 3/8in. x 2in. w/ 5/8in. long brass hex nuts (03.275-4)
\$4.50 SET

Heat Riser Spring



602799..... 37-54
Anti-rattle (03.653-4)
\$7.00 EA



838573..... 37-54
Thermostat (03.653-4)
\$17.25 EA

Heat Riser Shaft



596264A..... 37-54
Oversize requires reaming worn manifold holes (03.650-15)
\$23.00 EA

Flange Plate



593607..... 37-53
Holds header pipe to manifold, 216ci (03.610-15)
\$6.25 EA



3696988..... 51-57
235ci, also fits Fenton headers (03.610-15)
\$8.75 EA

Gasket



593606..... 37-49
Header pipe to manifold. (03.611-2)
\$2.75 EA

Returns require a return authorization number, please call.

130T: Exhaust System



Format = Part No., Year, Description, original Chevrolet Part Book Group No., Price and Unit Measure.

Gasket



3692831 **50-54**
Header pipe to manifold. (03.611-2)
\$3.25 EA

Spring



368244 **32-48**
Supports rear of header pipe (exc 40-46 1T & 39-46 utility).
(04.827-15)
\$6.50 EA

Header Pipe

3652725 **37-40**
All (03.609-15)
\$56.00 EA

3684108 **41-48**
All (03.609-15)
\$56.00 EA

3691277 **49**
All (03.609-15)
\$56.00 EA

3693712 **50-53**
All with 216ci motor. (03.609-15)
\$68.00 EA

3693715 **50-54**
All with 235ci motor. (03.609-15)
\$62.00 EA

Oversize shipping charges apply to all Header Pipes. Please call for rate.

Muffler



Muffler style & sizes vary

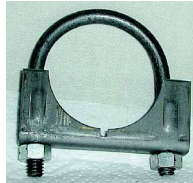
603746 **35-40**
(03.701-15)
\$51.00 EA

3656598 **41-49**
(03.701-15)
\$51.00 EA

Muffler

3693710 **50-54**
(03.701-15)
\$85.75 EA

Muffler Clamp



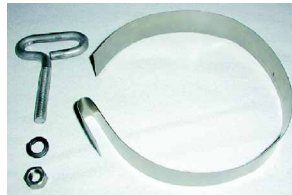
3693812 **37-49**
Rear, 1-5/8in. (03.708-4)
\$2.00 EA

3693811 **50-54**
Rear, 1-7/8in. (03.708-4)
\$2.50 EA

3693811 **37-49**
Front, 1-7/8in. (03.708-4)
\$2.50 EA

3694837 **50-54**
Front, 2in. (03.708-4)
\$2.00 EA

Muffler Hanger



3676257 **37-55**
(03.704-15)
\$6.00 EA

Tailpipe

599415 **37-40**
1/2T (03.705-15)
\$54.00 EA

599397 **37-40**
3/4T (03.705-15)
\$56.00 EA

3656764 **41-46**
1/2T (03.705-15)
\$56.00 EA

3657135 **41-49**
3/4T (03.705-15)
\$56.00 EA

Tailpipe

3656962 **41-49**
1-1/2T w/ 134-1/2in. wheelbase & 1t.
(03.705-15)
\$56.00 EA

3683656 **47-49**
1/2T (03.705-15)
\$56.00 EA

3696806 **50-54**
1/2T (03.705-15)
\$56.00 EA

3689574 **50-54**
Panel, Suburban, Canopy Express.
(03.705-15)
\$56.00 EA

3696161 **50-54**
3/4T exc Double Duty. (03.705-15)
\$56.00 EA

3715243 **50-59**
1T (03.705-15)
\$56.00 EA

3692828 **50-54**
1-1/2T & 2T, 8-3/8in long. (03.705-4)
\$23.00 EA

Oversize shipping charges apply on all tailpipes. Please call for rates.

Tailpipe Hanger



3656791 **37-54**
Correct reproduction. (03.706-15)
\$6.50 EA



3656791A **37-54**
Replacement. (03.706-15)
\$5.00 EA

130T

Providing part #'s speeds up your order, improves accuracy, and helps us maintain low prices.

See Illustration Index for core charge information and a list of abbreviations. For Body Model information, see 5T.



130T: Exhaust System

Format = Part No., Year, Description, original Chevrolet Part Book Group No., Price and Unit Measure.

Tailpipe Heat Shield



3689481R.....37-46
Under bed. (03.706-15)
\$6.75 EA



3689481S.....47-54
Under bed. (03.706-15)
\$7.00 EA

Tailpipe Clamp



594135..... ALL
Clamp, original for tailpipe extension w/ nut & bolt. (03.708-15)
\$3.50 EA

Exhaust Extension



985992A..... ALL
Era accessory stainless steel w/ stamped bowtie. (03.705-2)
\$21.00 EA



985992C..... ALL
CHROME Bowtie shaped outlet. 2-1/4" I.D. (not pre-drilled). (03.705-2)
\$31.50 EA



986885S..... ALL
STAINLESS STEEL Bowtie shape w/ mounting screws. 2-1/4" I.D. (not pre-drilled). (03.705-15)
\$44.00 EA



985848.....42-48
Bear Claw shape. Superb chrome reproduction of original. (03.705-15)
\$83.50 EA

Paint



3657963FA..... ALL
Very high temp, flat aluminum for manifolds & pipes. 12 oz spray can. (03.609-15)
\$10.00 EA



3657963E..... ALL
Clear, high temp (1200 degree) for exhaust etc, 12 oz spray can. (03.609-15)
\$10.00 EA



3657963C..... ALL
Stainless steel pigments. For exhaust manifolds & pipes. Gives a soft gray, metallic finish. (03.609-15)
\$13.00 PT

Paint



3657963D..... ALL
Cast blast high temp 1200 degree. Gray, fresh cast look for exhaust manifolds, etc. Rust preventative, 12 oz spray can. (03.609-15)
\$9.25 EA

Odds & Ends

Please call for availability on all Odds & Ends parts; once part is sold, it may no longer be in stock.

602366U..... 37-39
Exhaust Manifold- Good Used (1-0)
\$75.00 EA

839005..... 45-54
Intake manifold for 235ci. (03.265-0)
\$75.00 EA

3694163..... 50-57
Intake manifold. Fits all exc 216ci & DD (Used) (03.609-0)
\$65.00 EA.

3835881..... 37-53
Intake & exhaust manifold. Fits 216ci. (03.601-0)
\$175.00 EA

Returns require a return authorization number, please call.



140T: Clutches & Flywheels

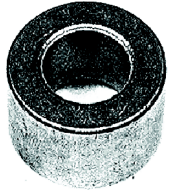
Format = Part No., Year, Description, original Chevrolet Part Book Group No., Price and Unit Measure.

Pilot Bearing



907109 31-39
(00.649-2)
\$22.00 EA

Pilot Bushing



412562 39-66
(00.649-4)
\$5.25 EA

Throwout Arm Ball



2054961C 32-37
2 pieces w/o clips or lockwasher. (00.796-0)
\$15.00 EA



2054961 38-54
Stud, 1-1/2in. long.
(00.796-15)
\$9.00 EA

Clip



838987 31-54
Throwout arm to ball stud. (00.823-3)
\$5.75 EA

Throwout Bearing

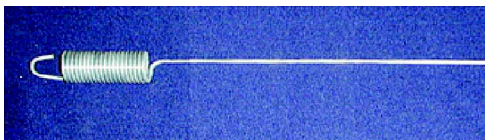


909422 38-54
(00.799-15)
\$33.25 EA

Throwout Arm Spring



3664881 41-46
7-5/16in. (00.844-15)
\$7.50 EA



3653114 47-54
6in. (00.844-15)
\$6.25 EA

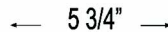
Clutch Pedal Return Spring



368244 32-46
(04.827-15)
\$6.50 EA



3698665 47-57
Overall length 5-3/4in.
(04.827-2)
\$5.00 EA



Clutch Linkage Rod



3676454 47-59
Rod 7-1/16in. (1 hook & 1 eye). (00.787-15)
\$6.00 EA



3676398 47-59
Offset rod (I shape) 2-1/4in. (00.787-15)
\$14.00 EA

Pressure Plate-Rebuilt



838956 38-53
9in. (\$50 core). (00.863-15)
\$80.00 EA

838949 38-53
Heavy duty, 10-3/4in. (\$50 core).
(00.863-15)
\$80.00 EA

3836715 54-57
Use w/ 9in. & 10in. disc (\$50 core).
(00.863-15)
\$86.00 EA

Clutch Disc-Rebuilt



3847450 38-54
9in. o.d. (\$40 core). (00.886-15)
\$41.25 EA

3835483 38-53
10-3/4in. o.d. (\$40 core). (00.886-2)
\$68.00 EA

Clutch Disc-Rebuilt

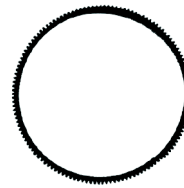
3836119 54-57
10in. (\$40 core). (00.886-15)
\$48.00 EA

Tool



838956A ALL
To align clutch disc.
(00.866-4)
\$7.00 EA

Flywheel Ring Gear



838177 37-54
139 teeth (exc powerglide). (00.667-4)
\$60.00 EA

Odds & Ends

Please call for availability on all Odds & Ends parts; once part is sold, it may no longer be in stock.

3835453N ALL
Clutch Disc, 10-3/4in. (NOS) Fits 216ci. Truck. (0.886-0)
\$75.00 EA

2054960N 38-42
Clutch fork screw (NOS) (00.796-0)
\$10.00 EA

3836004 38-53
Pressure plate shelf worn, rusty. Fits Pass, 1/2T, 3/4T & Heavy Duty (04.667-0)
\$30.00 EA

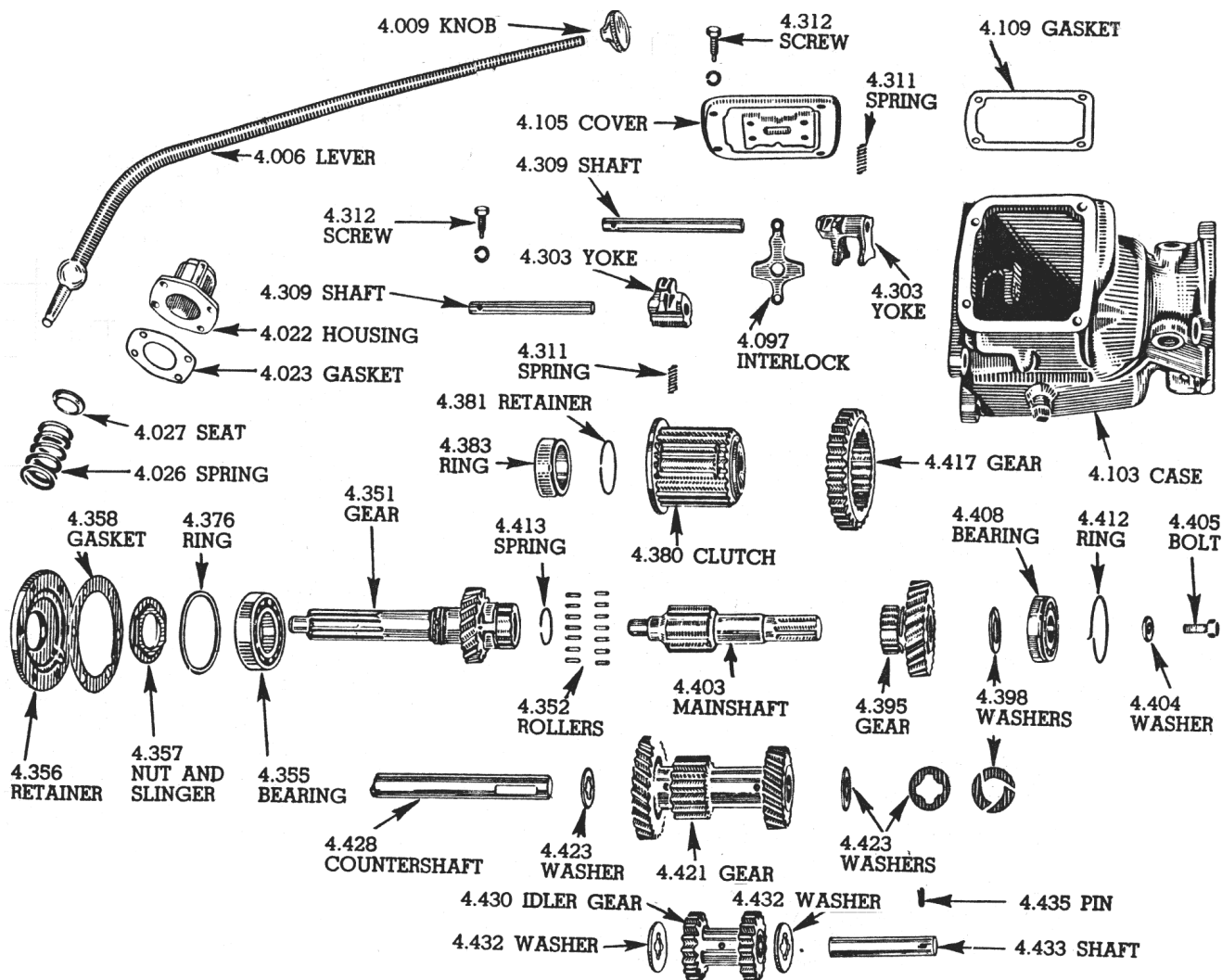
Returns require a return authorization number, please call.

150T: Transmissions, Shifters, Transmission Mounts & Related Speedo Cables

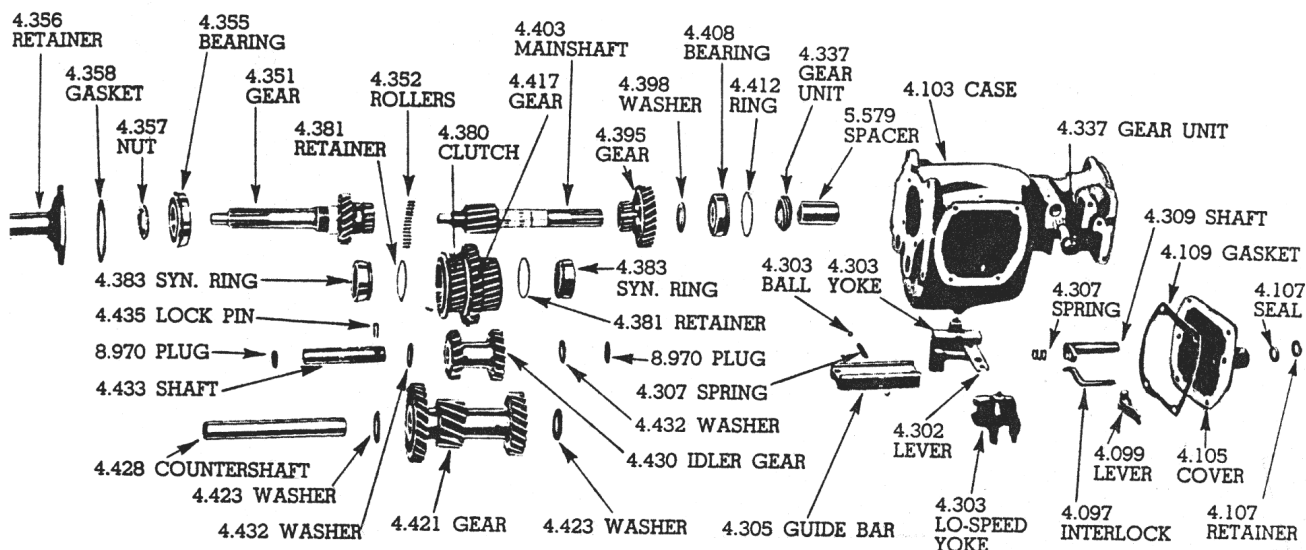


Format = Part No., Year, Description, original Chevrolet Part Book Group No., Price and Unit Measure.

150T



1937-47 SYNCHRO-MESH TRANSMISSION (CENTER GEARSHIFT)



1939-48 PASS. SYNCHRO-MESH TRANSMISSION (STEERING COLUMN GEARSHIFT)

Providing part #'s speeds up your order, improves accuracy, and helps us maintain low prices.

See Illustration Index for core charge information and a list of abbreviations. For Body Model information, see 5T.



150T: Transmissions, Shifters, Transmission Mounts & Related Speedo Cables

Format = Part No., Year, Description, original Chevrolet Part Book Group No., Price and Unit Measure.

Street Rod Parts

Speedometer Cable Kits (Lokar)

Premium Teflon-lined housing w/ machined aluminum fittings. Inner cable & outer housing can be cut to fit. Kit comes complete w/all fittings for GM applications. Fits TH-350, TH-400, 700-R4, Powerglide, TH-200, 200-R4 & 4L60.



SP-1500U ALL
Black housing.
(04.342-15)
\$66.25 EA



SP-1501HT ALL
Stainless braid housing.
(04.342-15)
\$105.50 EA

Line Clamp



- 13274 ALL 3/16in. single (12 clamps). (08.950-15).....\$17.00 SET
- 13277 ALL 1/4in. single (12 clamps). ... (08.950-15).....\$17.00 SET
- 13278 ALL 5/16in. single (12 clamps). (08.950-15).....\$17.00 SET
- 13279 ALL 3/8in. single (12 clamps). ... (08.950-15).....\$17.00 SET
- 13280 ALL 1/2in. single (12 clamps). ... (08.950-15).....\$17.00 SET
- 13281 ALL 5/8in. single (8 clamps). (08.950-15).....\$17.00 SET
- 13282 ALL 3/4in. single (8 clamps). (08.950-15).....\$17.00 SET
- 13283 ALL 7/8in. single (8 clamps). (08.950-15).....\$17.00 SET

Line Clamp



- 13276 ALL 3/16in. x 3/16in. double (6 clamps). (08.950-15) \$17.00 SET
- 13285 ALL 1/4in. x 1/4in. double (6 clamps). (08.950-15) \$17.00 SET
- 13286 ALL 5/16in. x 5/16in. double (6 clamps). (08.950-15) \$17.00 SET
- 13287 ALL 3/8in. x 3/8in. double (6 clamps). (08.950-15) \$17.00 SET
- 13288 ALL 1/2in. x 1/2in. double (6 clamps). (08.950-15) \$17.00 SET
- 13289 ALL 5/8in. x 5/8in. double (4 clamps). (08.950-15) \$17.00 SET
- 13290 ALL 3/4in. x 3/4in. double (4 clamps). (08.950-15) \$17.00 SET
- 13291 ALL 7/8in. x 7/8in. double (4 clamps). (08.950-15) \$17.00 SET



- 13275 ALL 3/16in. x 3/8in. combination (6 clamps).(08.950-15).... \$17.00 SET
- 13284 ALL 5/16in. x 3/8in. combination (6 clamps).(08.950-15).... \$17.00 SET

Restoration Parts

Note: Die cut pad & gaskets for floor insert over transmission see Section 320T.

Shift Knob



374993 29-47
3-speed floor shift push-on. Black. (04.009-15)
\$7.75 EA

Shift Knob



374993B.....29-54
4-speed screw-on. Black. (04.009-15)
\$7.50 EA



98509937
Brown, accessory. (04.009-15)
\$30.25 EA



368689847-53
Maroon. (04.009-15)
\$6.00 EA



369823354-59
Black (04.009-15)
\$6.00 EA

Floorshift Seal



365342037-47
Floor to transmission 3-speed. (04.015-15)
\$18.00 EA



368720037-54
Floor to transmission 4-speed. (04.015-2)
\$5.00 EA

Floor Shift Boot



3651348A..... ALL
Replacement-3 speed (uses #3654365t trim ring). (04.015-4)
\$9.00 EA

Returns require a return authorization number, please call.

150T: Transmissions, Shifters, Transmission Mounts & Related Speedo Cables



Format = Part No., Year, Description, original Chevrolet Part Book Group No., Price and Unit Measure.

Trim Ring



3654365TALL
Stainless retains boot
#3651348A.
(04.044-15)
\$12.00 EA

Bushing



36524448-53
Rubber shift rod ends (4 pcs). (04.016-2)
\$8.50 SET

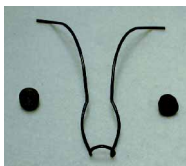
36524454
Rubber shift rod ends (6 pcs). (04.016-2)
\$12.50 SET

Bracket-Shift Tube Support



3698234 48-54
Supports top of shift
tube under steering
wheel. (04.018-15)
\$17.75 EA

Spring & Pivot Pins



3654731 40-57
Column shift handle (fits
40-54 car & 48-57
truck). (04.025-4)
\$8.25 SET

Pivot Pins



3653719 40-57
Column shift handle (2
pcs). (04.025-2)
\$2.50 PR

Metal Plug



142024 48-54
In shift box (also 49-54
car). (09.008-3)
\$1.00 EA

Rubber Bellows



3686796..... 48-59
On shift box, base of
steering column.
(04.015-4)
\$6.25 EA

Bearing



435844..... 37-57
Front bearing on main
drive gear. (04.355-15)
\$24.75 EA



95416837-54
Rear of trans case (tail shaft). (04.408-2)
\$30.00 EA

Tailshaft Bushing



3717682..... 48-54
Rear of tailshaft, 1/2T,
4-speed. (04.445-4)
\$16.75 EA

Shift Fork



3845048..... 49-55
2nd & 3rd gear (\$15
core). (04.303-15)
\$57.00 EA



591660..... 48-55
Seal for inside cover, 3-
speed (2 pcs).
(04.107-3)
\$12.50 SET

Transmission Gasket Set



3764394..... 37-54
3-speed. (04.005-15)
\$16.25 SET

Transmission Gasket Set



606664..... 31-47
4-speed. (04.005-15)
\$20.00 SET



3689458 48-63
Muncie 4-speed. (04.005-15)
\$12.00 SET

Reverse Idler Gear



591264..... 41-47
4 speed. (04.430-0)
\$30.00 EA

Cluster Gear



591074..... 40-53
3 speed for bushing
type. (04.421-3)
\$156.00 EA

Cluster Shaft



591213 40-57
3 speed roller bearing type. Fits bushing w/
modifications. (04.428-0)
\$20.00 EA

Bushing



591210..... 37-53
Fits bushing-styled
cluster (2 pcs).
(04.422-4)
\$14.00 SET

150T

Providing part #'s speeds up your order, improves accuracy, and helps us maintain low prices.

See Illustration Index for core charge information and a list of abbreviations. For Body Model information, see 5T.



150T: Transmissions, Shifters, Transmission Mounts & Related Speedo Cables

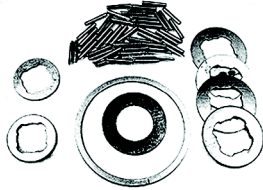
Format = Part No., Year, Description, original Chevrolet Part Book Group No., Price and Unit Measure.

Soft Plug



103892.....39-48
End of cluster shaft & reverse idler shaft.
(08.970-4)
\$1.00 EA

Small Parts Kit



609926 37-54
Thrust washers, needle bearings (3-speed). (04.004-2)
\$41.00 KIT

Transmission Rebuild

591187T ALL
3 speed rebuild. Includes gaskets, bearings and small parts kit. Other parts extra (please remove side covers & speedo gears prior to shipping). Oversized shipping charges apply. Please call for rates. (04.003-0)
\$450.00 EA

Transmission Mount



3652730A.....37-54
Rebuild kit: Pad & bolts.
(04.081-15)
\$8.00 SET



59411737-39
(04.081-2)
\$65.00 EA



3711049B.....42-57
Rubber, for turbo 350, 2-hole mount only.
(04.081-3)
\$12.00 EA

3711049C 42-57
Rubber, for turbo 350, turbo 400, & 400R, 1-hole mount. (04.081-3)
\$10.50 EA

Speedometer Cable



1567793.....37-57
W/ original housing assembly exc 1939-54.
(04.342-2)
\$34.50 EA
158829.....39-54
W/ original metal housing assembly.
(04.342-3)
\$35.25 EA



158829P.....39-54
W/ plastic housing assembly. (04.342-15)
\$20.00 EA
1588291A 37-57
Cable w/o housing. (04.342-2)
\$15.50 EA



1565706 37-57
Tip, steel (speedometer end of, speedo cable).
(04.342-3)
\$4.50 EA

Shift Lever



3656434 37-47
(Upper) Floor Shift. 37-39 Pass, 37-47 Truck.
(04.022-0)
\$17.50 EA

Odds & Ends

Please call for availability on all Odds & Ends parts; once part is sold, it may no longer be in stock.

591780.....49-54
2 & 3rd Shifter Shaft W Plate (12-0)
\$12.00 EA
590929N 37-39
2nd Gear-all 3 Speed (12-0)
\$35.00 EA

Odds & Ends

142260..... 37-57
Bearing Center S Front (All 4 speed) (12*000-0)
\$30.00 EA.
121856..... 31-47
Bearing counter shaft rear (4-speed) (12*000-0)
\$20.00 EA
954451..... 37-39
Bearing diff. side 37-39 all util. (5.536-0)
\$40.00 EA.
954358..... 48-57
Bearing Front On Main Drive Gear (04.355-0)
\$24.75 EA
590545..... 32-36
Bearing - trans main drive gear (4.355-0)
\$45.00 EA
954373..... 31-47
Bearing, Trans, Main Drive Gear ALL (12*000-0)
\$20.00 EA.
3661395U 41-42
Bearing yoke trunnion. Fits 235 (Used) (12*000-0)
\$10.00 EA
904913..... 54-55
Bearing 3 Speed, rear trans (COMM) (04.405-0)
\$30.00 EA
902100..... 30-39
Bearing Differential (1/2, 3/4 & 1 Ton) (05;536-0)
\$30.00 EA
954864..... 48-57
Bearing Main Shaft Rear (4 speed) (04.408-0)
\$30.00 EA
905207..... 41-47
Bearing Propeller Shaft (5.436-0)
\$30.00 EA
5560..... 29-54
Brass insert. Repairs worn trans (13-0)
\$25.00 EA
3663239..... 39-69
Cap steel front prop shaft (NOS) (04.341-0)
\$20.00 EA
3687429..... 48-54
Clamp, Gearshift Selector housing (12^000-0)
\$10.00 EA

Returns require a return authorization number, please call.

150T: Transmissions, Shifters, Transmission Mounts & Related Speedo Cables



Format = Part No., Year, Description, original Chevrolet Part Book Group No., Price and Unit Measure.

Odds & Ends

590927	37-39
3-speed (04.421-3)	
\$160.00 EA	
591191	40-57
Cluster gear. 3-speed for roller bearing type. (04.421-3)	
\$160.00 EA	
364495	34-37
Clutch Fork NOS (COMM, Utility) (12*000-0)	
\$25.00 EA	
3692835	50-54
Collar, U-joint Ball 50-54 Pass Powerglide (13-0)	
\$25.00 EA	
591603	48-57
Clutch Gear Synchronizing Cone 4 Speed (04.384-0)	
\$35.00 EA	
591667	48-50
Counter Gear, 1st Speed all w/ 4 speed (12*000-0)	
\$75.00 EA	
590826	32-40
Counter gear thrust washer (04.423-0)	
\$10.00 EA	
590620	33-36
Counter Shaft, 3 Speed Exc CC DC EC (12-0)	
\$15.00 EA	
591394	31-57
Counter Shaft Gear Key NOS 4 speed (4.421-0)	
\$6.50 EA	
357665	54-57
Differential Bearing Adjuster nut (13~000-0)	
\$25.00 EA	
3652336	40-53
Differential Case, 40-42 COMM, 46-53 1/2T, 53-57 1/2T (05.510-0)	
\$125.00 EA	
609951	34-37
Fork Unit Clutch Release COMM & Utility (12*000-0)	
\$20.00 EA.	
590481	31-37
Front Main Bearing Retainer (12-0)	
\$25.00 EA	

Odds & Ends

591298	38-46
Front Main Bearing Retainer 4 speed (12~000-0)	
\$20.00 EA	
954394	46-50
Front pinion bearing. All 1/2T (NOS) (04.355-0)	
\$50.00 EA	
591113	40-54
Gear. 1st & Reverse sliding (NOS). Exc heavy duty. (04.417-0)	
\$30.00 EA	
591578	48-50
Gear 2nd speed for 4-spd constant mesh (NOS) (04.395-0)	
\$20.00 EA	
590387	29-42
Gear shift lever cap 4 speed (04.015-0)	
\$25.00 EA	
590493	31-47
Gear trans High Speed Sliding (12*000-0)	
\$25.00 EA.	
3705067	37-39
Gear. Transmission main drive for 3-speed. (04.403-0)	
\$100.00 EA	
18860	54
Gearshift 1st & Rev Linkage (NOS) (12-0)	
\$15.00 EA	
3686836	48-54
Gearshift Operating Lever & Clamp (12-0)	
\$12.00 EA	
591501	48-54
Input shaft COMM & Utility w/ 4 speed (04;351-0)	
\$25.00 EA	
3688159	49-55
Lever, Gearshift Selector, 2nd & 3rd (5-1/4in overall length), fits 49-54 pass 3sp, 53-55 DD 3sp 1st series, (4.016-0)	
\$15.00 EA	
3686812	48-55
Lever, Gearshift Selector, 2nd & 3rd (4-1/4in) fits 48-52 COMM, 53-55 COMM 1st series exc DD, 55 COMM 3sp 6 cyl 2nd series (04.016-0)	
\$15.00 EA	
954869	48-57
Main shaft gear (04.112-0)	
\$40.00 EA	

Odds & Ends

5668232	55-56
Mast jacket bearing assembly, fits COMM & Utility (06.521-0)	
\$40.00 EA	
590621	32-36
Oil Slinger, Main Drive Gear (12-0)	
\$8.00 EA	
3682372	46-47
Propeller shaft bearing retainer (NOS) (05.439-0)	
\$20.00 EA	
591620	48-54
Retainer trans Main Drive Bearing (12*000-0)	
\$30.00 EA	
591119	40
Retainer trans rear bearing (All 4 speed) (04.317-0)	
\$45.00 EA	
3656434N	40-47
Retainer-gearshift Lever Ball 3 Speed (12-0)	
\$35.00 EA	
3694491	51-54
Reverse Band Brake Strut, P/g (NOS) (12-0)	
\$70.00 EA	
590925	37-39
Reverse idler gear for 3 Speed (NOS) (12-0)	
\$30.00 EA	
472931	32-36
Reverse idler gear. Fits standard w/ 3-speed. (4.43-0)	
\$30.00 EA	
3691568N	50-52
Ring-washer torque conv retain NOS (13*000-0)	
\$6.00 PR	
590517	31-47
Shaft 1st & 2nd speed, all w/ 4 speed (12*000-0)	
\$10.00 EA	
590853	37-39
Shift Yoke Shaft 1st & Reverse All 3 speed (12*000-0)	
\$35.00 EA	
3653607	40
Torque tube U-Joint housing rear (13*000-0)	
\$35.00 EA	

150T

Providing part #'s speeds up your order, improves accuracy, and helps us maintain low prices.

See Illustration Index for core charge information and a list of abbreviations. For Body Model information, see 5T. 101



150T: Transmissions, Shifters, Transmission Mounts & Related Speedo Cables

Format = Part No., Year, Description, original Chevrolet Part Book Group No., Price and Unit Measure.

Odds & Ends

- 591631 48-54**
Transmission case. For 3-speed commercial (Used). (04.103-0)
\$125.00 EA
- 591103 40**
Trans Case, COMM w/ 3 speed NOS (12^000-0)
\$150.00 EA
- 5908959 37-42**
Trans cover shift plate 3 speed floor shift 37-39 car 37-42 truck (04.105-0)
\$0.00 EA
- 3692608 48-57**
Trans Main Shaft 4 speed (All) (12^000-0)
\$65.00 EA.
- 590654 32-36**
Trans. Synchronizing Drum exc CC & DD (12-0)
\$25.00 EA
- 3686832U 48-50**
Transmission inspection cover 3spd (Used) (4.105-0)
\$75.00 EA
- 1307238 54-61**
Transmission Oil Plug w/ Seal (NOS) (12-0)
\$6.00 EA
- 591906 48-57**
Yoke, 1st & 2nd Speed All (4sp) (12^000-0)
\$30.00 EA.
- 141854 31-47**
Bearing Main Shaft Roller. All 4 speed (04.352-0)
\$20.00 EA.
- 591288 37-54**
Synchronizer Energizing Spring. 3-spd, 1-5/16" id x 1-3/8" oc x 7/64" thick (Used). (04.413-0)
\$12.00 EA



1950 Truck

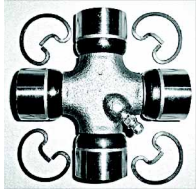
Returns require a return authorization number, please call.

160T: Drive Lines



Format = Part No., Year, Description, original Chevrolet Part Book Group No., Price and Unit Measure.

U-joint Cross Assembly



609948 33-53
33-39 4 speed front,
rear exc VE, VF; 40
front exc KC, WD; 41-53
front 3/4 exc Double-
Duty. (05.548-3)
\$38.00 EA



609944 40-54
Fits car & 1/2T.
(05.548-15)
\$42.00 EA

U-joint Lock Plates



3723489 40-54
2 plates & 4 bolts.
(05.586-15)
\$11.00 SET

U-joint Assembly

602795 37-39
W/ yokes, 3/4T, 3-speed. (05.548-15)
\$175.00 EA

604373 40-47
W/ yokes 3/4 & 40 1t 3-speed front.
(05.548-4)
\$150.00 EA

3653380 40
W/ yokes 1-1/2T (exc WD). (05.548-0)
\$150.00 EA



606799 40-47
W/ yokes 1/2T 3-speed. (05.548-3)
\$175.00 EA

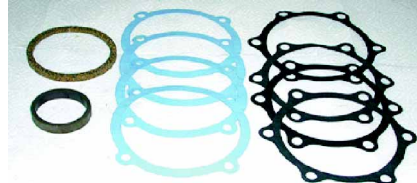
591646 41-53
W/ yokes 3/4T 3-speed. (05.548-15)
\$175.00 EA

591642 48-54
W/ yokes 1/2T 3-speed. (05.548-15)
\$110.75 EA

Torque Tube



3723490P 29-54
Ball seal kit, for drive
shaft. Fits 29-40 & 41-
54 cars w/ Powerglide.
(05.572-15)
\$13.50 EA



3723490 29-54
Ball seal kit, for drive shaft 29-40 & 41-54
cars, 1/2T & 3/4T truck w/ manual trans.
(05.572-15)
\$13.50 EA

Dowel Pin



347813 29-50
5/16in. , retains drive shaft bushing.
(05.450-3)
\$4.50 EA

Coupling Pin



3657332 40-54
Drive shaft to pinion. (05.457-3)
\$8.00 EA

Drive Shaft Bushing



596907 37-53
Front, 3/4T & 38-40 1T.
(05.451-4)
\$20.00 EA



3652328 40-50
Rear, 50 1st design.
(05.451-15)
\$28.00 EA

Drive Shaft Bushing

3694733 51-54
Rear, 1/2T. (05.451-2)
\$30.00 EA

Drive Shaft Seal



595010 37-39
1/2, 3/4 & 1T. (05.469-15)

\$9.00 EA

3691457 40-50
40 all & 41-50 1/2T. (05.469-15)
\$10.25 EA

Oakie Bushing

Replaces front & rear drive shaft
bushing & seal without disassembling
rear end and driveline.

595005B 37-39
1/2T, 3/4T & 1T. (05.451-15)

\$60.00 EA



3652328B 40-50
Car, 1/2, 3/4 & 1T. (05.451-15)

\$60.00 EA

3694733B 51-54
Car, 1/2, 3/4 & 1T. (05.451-0)

\$77.50 EA



609930A 40-50
Seal. (05.451-15)
\$5.00 EA

160T

Providing part #'s speeds up your order, improves accuracy, and helps us maintain low prices.

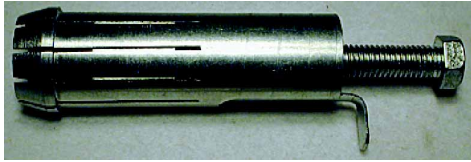
See Illustration Index for core charge information and a list of abbreviations. For Body Model information, see 5T. 103



160T: Drive Lines

Format = Part No., Year, Description, original Chevrolet Part Book Group No., Price and Unit Measure.

Tool



595005A..... **37-54**
Drive shaft bushing puller to rent (return in original condition for \$20 refund). (05.451-15)
\$40.00 EA

Odds & Ends

Please call for availability on all Odds & Ends parts; once part is sold, it may no longer be in stock.

954452 **30-39**
Bearing Pinion Shaft Front 30-36 PA (13*000-0)
\$30.00 EA.

954455 **33-39**
Bearing Pinion Shaft Front All Utility (13*000-0)
\$75.00 EA.

905113 **33-35**
Bearing-pinion Shaft Front (13-0)
\$20.00 EA

365393 **40**
Prop Shaft Bushing, Rear (Utility) (13*000-0)
\$20.00 EA

Odds & Ends

3705198..... **54-57**
Rear bearing dust shield (05.438-0)
\$25.00 EA

366989..... **31-38**
Lock Ring, Front Prop. Shaft Bearing (13-0)
\$5.00 EA

901105..... **33-35**
Pinion shaft bearing. Rear exc CC (13-0)
\$25.00 EA

370416..... **33-39**
Prop Shaft Bushing, Front (Utility) (13*000-0)
\$20.00 EA

600962..... **34-40**
Prop Shaft Bushing, Front Utility (13*000-0)
\$20.00 EA

Odds & Ends

3653931..... **40**
Propeller shaft housing bushing front (13*000-0)
\$25.00 EA

373526..... **34-36**
Torque tube U-joint housing. Fits DA,DB (05.664-0)
\$20.00 EA

376203..... **35-39**
U-Joint Rear 3 & 4 Speed (13*000-0)
\$165.00 EA

609944N **40-54**
U-joint rebuild kit. Fits car & 1/2 ton truck (NOS) (-0)
\$40.00 EA



1941 1/2 Ton—Sid & Pat Rice, Montana



Returns require a return authorization number, please call.

170T: Rear Axles, Bearings & Seals



Format = Part No., Year, Description, original Chevrolet Part Book Group No., Price and Unit Measure.

Street Rod Parts

Rear Axle Cover

475308 **37-62**
 Chrome with chrome filler plug. Chevy
 1/2Ton & 1937-42 3/4 and 1Ton trucks.
 (05.398-15)
\$50.00 EA

Restoration Parts

Ring & Pinion



3705439A..... **40-54**
 Conversion 3.55:1 (bolt in 40-50, 1937-39
 requires drive line modification).
 (05.529-15)
\$400.00 SET

Gaskets, Seals, Bearings

3705430KT **40-50**
 Gaskets, Seals, Bearings (05.529-0)
\$300.00 SET

3705439KT
 Gaskets, Seals, Bearings (05.529-0)
\$300.00 SET



3657740B **37-55**
 Shim Kit (05.460-15)
\$10.00 SET

Rear Axle Seal



592441 **33-54**
 1/2T & 37-42 3/4 & 1T. (05.822-15)
\$14.50 EA

Rear Axle Seal



3686563..... **46-57**
 3/4 & 1T. (05.822-2)
\$8.25 EA

Rear Axle Bearing & Seal



111121B..... **37-54**
 (05.855-15)
\$68.00 SET

188930B..... **46-57**
 3/4 & 1T. (05.855-15)
\$51.50 SET

Rear Axle Bearing

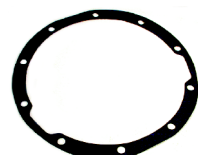


111121..... **37-54**
 1/2T & 37-42 3/4 & 1T.
 (05.855-15)
\$58.00 EA



188930..... **46-57**
 3/4 & 1T. (05.855-15)
\$43.25 EA

Gasket-Axle



370245..... **37-59**
 Center cover on rear
 axle, rear gasket, 1/2T
 & 37-42 3/4 & 1T.
 (05.399-15)
\$6.00 EA



370246..... **37-59**
 Differential to axle
 housing, front gasket,
 1/2T & 37-42 3/4 & 1T.
 (05.508-15)
\$3.50 EA

Differential Fill



344829 **29-54**
 Plug w/ gasket.
 (05.400-15)
\$5.75 EA

Carrier Bearing



7450385 **46-56**
 1/2T & 37-42 3/4T & 1T
 (uses 2). (05.536-15)
\$60.00 EA

Pinion Seal



3653618 **40-57**
 40 COE, 41-42 1-1/2T &
 larger (exc 1/2T & 40-55
 2-speed). (05.469-15)
\$15.00 EA

Pinion Bearing



954780 **35-54**
 Front, Passenger &
 1/2T. (05.447-15)
\$57.50 EA



125630 **35-54**
 Rear. Cars; 35-54 pass
 & 53-55 Corvette.
 Trucks; 35-42 COMM,
 46-54 1/2 Ton
 (05.484-15)
\$65.00 EA

Bushing & Bolt W/ Nut



3652182A **48-54**
 Bolt w/ nut, rear end to
 spring, 1/2T. (05.403-2)
\$27.25 PR

170T

Providing part #'s speeds up your order, improves accuracy, and helps us maintain low prices.

See Illustration Index for core charge information and a list of abbreviations. For Body Model information, see 5T. 105



170T: Rear Axles, Bearings & Seals

Format = Part No., Year, Description, original Chevrolet Part Book Group No., Price and Unit Measure.

Odds & Ends

Please call for availability on all Odds & Ends parts; once part is sold, it may no longer be in stock.

- 144535 36**
Bearing, inner axle shaft fits 1-1/2 ton (05.855-0)
\$25.00 EA
- 901604 48-50**
Bearing counter shaft rear (4-speed) (04.408-0)
\$30.00 EA
- 7450385N 46-56**
Carrier Bearing- 1/2in. (NOS) w/ race. (05.536-0)
\$60.00 SET
- 3714787 46-57**
Differential case 1/2T, 3/4T (05.517-0)
\$150.00 EA

Odds & Ends

- 364538 33-39**
Differential Case 1/2, 3/4 & 1 Ton (05.510-0)
\$150.00 EA
- 189638 32-36**
Rear pinion bearing 2 speed rear axle, vacuum shift (05.484-0)
\$25.00 EA
- 3847057 46-50**
Rod assy w/ 2spd rear axle (NOS) (05.635-0)
\$20.00 EA
- 3653928 40-47**
Spacer gasket, metal rear wheel hub w/ 1/2in. axle bolt holes fits utility (05.811-0)
\$10.00 EA
- 3651377 39-41**
Stud, shaft to hub cap 2 spd axle 1.5 ton (13*000-0)
\$6.00 SET



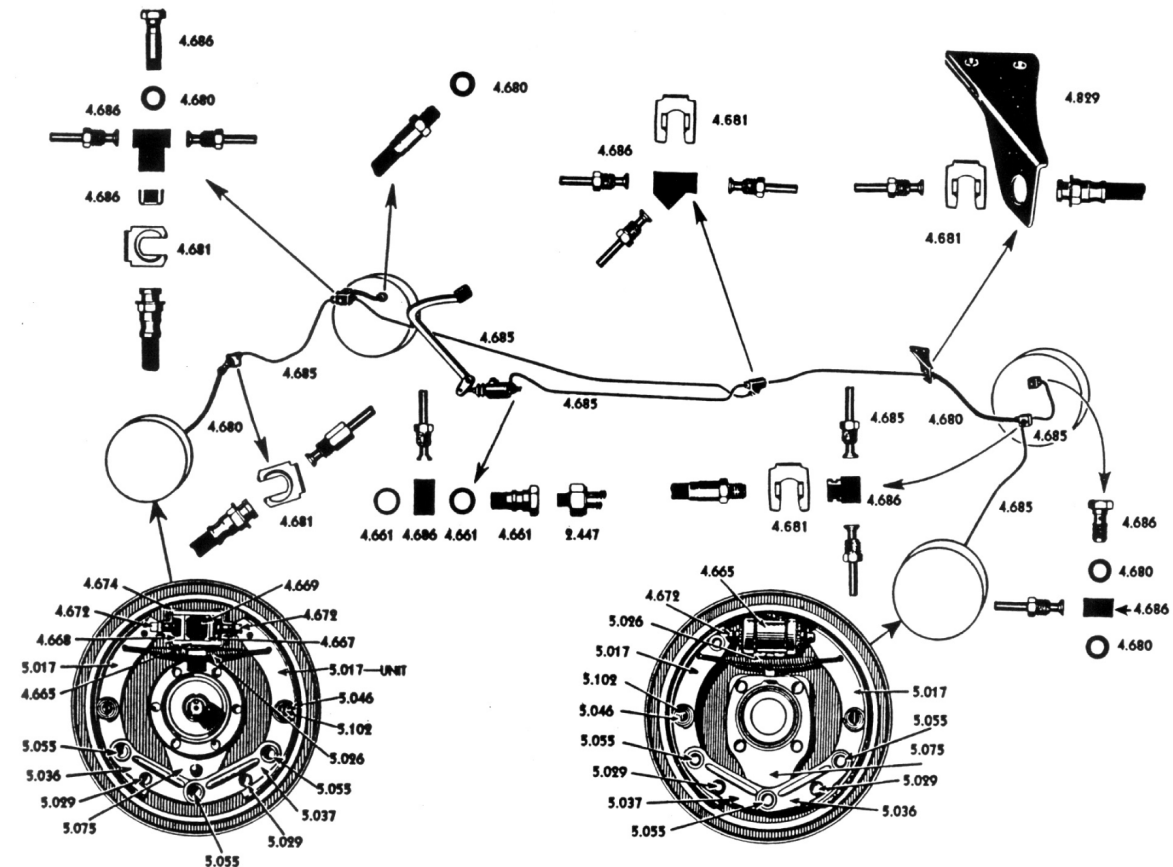
1950—William Tate, Missouri

Returns require a return authorization number, please call.

180T: Brake Parts

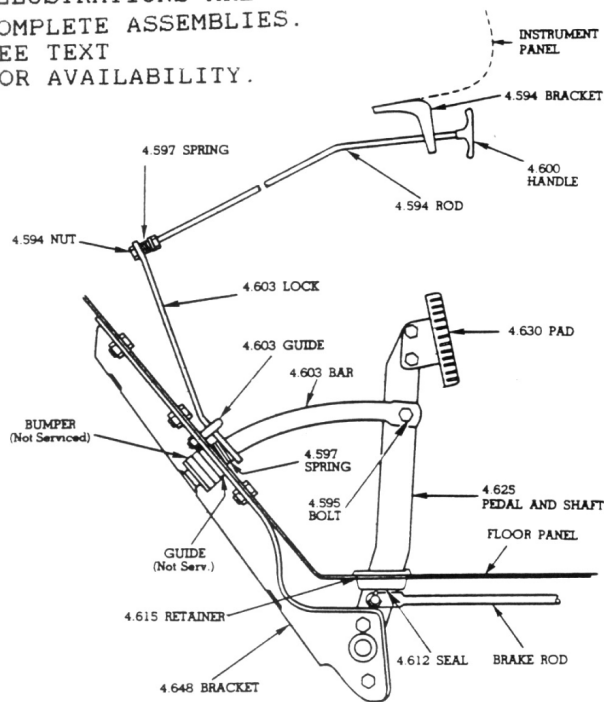


Format = Part No., Year, Description, original Chevrolet Part Book Group No., Price and Unit Measure.

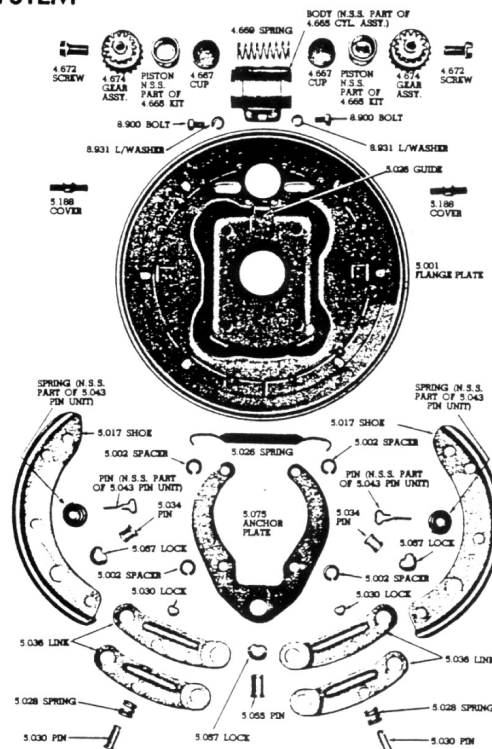


HYDRAULIC BRAKE SYSTEM

ILLUSTRATIONS ARE COMPLETE ASSEMBLIES. SEE TEXT FOR AVAILABILITY.



TRUCK PARKING BRAKE CONTROLS (FOOT OPER.)



HYDRAULIC BRAKE PARTS—FRONT

180T

Providing part #'s speeds up your order, improves accuracy, and helps us maintain low prices.

See Illustration Index for core charge information and a list of abbreviations. For Body Model information, see 5T. 107



180T: Brake Parts

Format = Part No., Year, Description, original Chevrolet Part Book Group No., Price and Unit Measure.

Street Rod Parts

Disc Brake Conversion Kit



ABS375 47-54
6 lug front w/ master cylinder and booster. Keep your 6 lug a 6 lug. Features rotors, Chevy truck calipers, brake hoses & dust caps. Master cylinder/ power brake unit features a 7-1/2" dual diaphragm booster, proportioning valve & adjustable rod to set your brake pedal height. (05.809-0)
\$845.00 SET

Brake Residual Valve



ABS10 ALL
10 Lbs. A must for applications where master cylinder is below calipers. (05.809-15)
\$19.00 EA



ABS2 ALL
2 Lbs. A must for applications where master cylinder is below calipers. (05.809-15)
\$19.00 EA

Disc Brake Conversion Brackets

Designed for firewall application & hanging pedals. Polished. Does not include proportioning valve or bracket for master cylinder.



5989081A 37-40
Brackets and mounting hardware. (05.809-15)
\$180.25 PR

Disc Brake Conversion Brackets

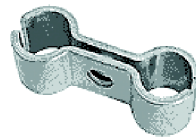
5989081B 41-50
Brackets and mounting hardware. (05.809-15)
\$190.00 PR
5989081C 51-54
Brackets and mounting hardware. (05.809-15)
\$180.25 PR

Master Cylinder & Brake Booster Assy



MASCYL1 47-54
Bolt in replacement using stock brake pedal. 7in. dual diaphragm brake booster. All new components. Specify your application-disc/disc or disc/drum. All bracketry included. Bolt-in application onto stock frames of 47-54 and 55 1st series trucks. (04.650-0)
\$399.00 EA

Separator



LC1737-D6 ALL
3/16" x 3/16". Use for brake, fuel, ignition wire, etc (08.950-15)
\$17.00 EA

Line Clamp



13274 ALL 3/16in. single (12 clamps). (08.950-15) \$17.00 SET
13277 ALL 1/4in. single (12 clamps)... (08.950-15) \$17.00 SET
13278 ALL 5/16in. single (12 clamps). (08.950-15) \$17.00 SET
13279 ALL 3/8in. single (12 clamps)... (08.950-15) \$17.00 SET

Line Clamp

13280 ALL 1/2in. single (12 clamps)... (08.950-15) \$17.00 SET
13281 ALL 5/8in. single (8 clamps)... (08.950-15) \$17.00 SET
13282 ALL 3/4in. single (8 clamps)... (08.950-15) \$17.00 SET
13283 ALL 7/8in. single (8 clamps)... (08.950-15) \$17.00 SET



13276 ALL 3/16in. x 3/16in. double (6 clamps). (08.950-15) \$17.00 SET
13285 ALL 1/4in. x 1/4in. double (6 clamps). (08.950-15) \$17.00 SET
13286 ALL 5/16in. x 5/16in. double (6 clamps). (08.950-15) \$17.00 SET
13287 ALL 3/8in. x 3/8in. double (6 clamps). (08.950-15) \$17.00 SET
13288 ALL 1/2in. x 1/2in. double (6 clamps). (08.950-15) \$17.00 SET
13289 ALL 5/8in. x 5/8in. double (4 clamps). (08.950-15) \$17.00 SET
13290 ALL 3/4in. x 3/4in. double (4 clamps). (08.950-15) \$17.00 SET
13291 ALL 7/8in. x 7/8in. double (4 clamps). (08.950-15) \$17.00 SET



13275 ALL 3/16in. x 3/8in. combination (6 clamps).(08.950-15).... \$17.00 SET
13284 ALL 5/16in. x 3/8in. combination (6 clamps).(08.950-15).... \$17.00 SET

Clamp



120521 ALL
1/4in. bolt-on strap. For wire or tube (4 pcs). (08.950-4)
\$2.50 SET

Returns require a return authorization number, please call.

180T: Brake Parts

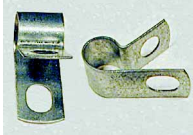


Format = Part No., Year, Description, original Chevrolet Part Book Group No., Price and Unit Measure.

Clamp



120521AALL
5/16in. insulated bolt-on
strap. For wire or tube
(4 pcs) (08.950-4)
\$2.50 SET



120521BALL
3/8in. bolt-on strap. For
wire or tube (4 pcs).
(08.950-4)
\$2.50 SET

Restoration Parts

Emergency Brake Release



3690404 48-51
Handle (chrome).
(04.592-15)
\$13.32 EA



1990717 52-53
Knob (maroon).
(04.600-15)
\$9.00 EA



1990717A 54
Knob (black).
(04.600-15)
\$10.00 EA

368725248-55
U-bolt for foot brake release lock guide.
(4.603-15)
\$9.25 EA

Emergency Brake Bracket



3687303 48-55
For foot operated pedal.
(04.648-15)
\$45.00 EA

Emergency Brake Cable



59732737-46
1/2T (takes 2). Does not include clevis.
(04.826-3)
\$80.00 EA
369417047-54
1/2T (takes 2) (1947-50 use your end).
(04.826-2)
\$45.75 EA

Gasket



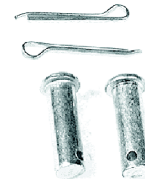
476136..... 36-54
Emergency cable to
backing plate.
(04.834-15)
\$3.00 PR

Boot



3691420..... 37-54
Emergency cable to
cable housing.
(04.834-4)
\$6.50 SET

Clevis End Pin



3682642..... 37-53
Emergency brake.
(04.833-15)
\$2.25 PR

Control Rod Assembly



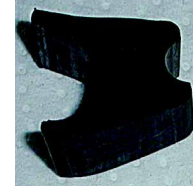
368929748-54
Emergency brake (1/2T). (04.826-15)
\$75.00 SET

Grommet



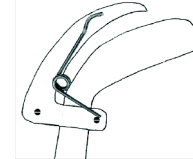
3696521..... 51-54
(09.775-15)
\$1.25 EA

Anti-Rattle Rubber Spacer



369387 37-54
Hand brake handle
release rod. (04.605-15)
\$4.50 EA

Spring



373980 32-57
Emergency hand brake
release lever.
(04.597-15)
\$4.50 EA

Brake Pedal Return Spring



368244..... 36-46
Overall length 3in.
(04.827-15)
\$6.50 EA



3698665..... 47-57
Overall length 5-3/4in.
(04.827-2)
\$5.00 EA

Bushings

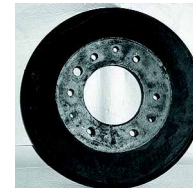


3682074..... 37-46
Clutch & brake pedal
shaft (13/16in. o.d. x
3/4in. i.d. x 1-25/64in. l)
(04.626-15)
\$12.00 PR

Brake Drum



602432A 36-50
Front, straight axle. 1/2T & commercial (6
lug). (05.809-15)
\$95.00 EA



601985 36-50
Rear 1/2T & 37-42 3/4T.
(05.809-15)
\$85.25 EA

180T

Providing part #'s speeds up your order, improves accuracy, and helps us maintain low prices.

See Illustration Index for core charge information and a list of abbreviations. For Body Model information, see 5T. 109



180T: Brake Parts

Format = Part No., Year, Description, original Chevrolet Part Book Group No., Price and Unit Measure.

Brake Drum

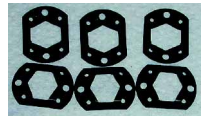
3696266 **51-56**
Front or rear 1/2T. (05.809-15)
\$72.00 EA

Gasket-Brake Drum



365673 **29-57**
Brake drum (6 lug) front
or rear. (05.819-3)
\$3.25 PR

Tinnerman Nuts



365897 **ALL**
Retains rear brake drum
(6 pcs). (05.810-4)
\$3.50 SET

Brake Shoes

Note. Inquire about Brake Shoes for Larger Trucks.



3681129 **36-52**
36-50 1/2T front & rear, 37-42 3/4t rear w/
11in. brakes 37-52 3/4 t front, 37-42 1t front
(does 2 wheels) \$15 core. (05.017-15)
\$34.00 PR

3696177 **51-56**
Front 2 wheels (\$15 core). (05.017-15)
\$26.00 SET

3695709 **51-56**
Rear 2 wheels (\$15 core) w55b.
(05.017-15)
\$33.50 SET

3703512 **53-59**
3/4 & 1 t front, 3/4 rear \$15 core (exc 14in.
brakes, duals & 7.50in. x 17in. tire).
(05.017-15)
\$48.25 PR

Brake Shoe Hold Down Kit



3696704 **51-57**
2 wheels (8 pcs).
(05.043-3)
\$7.50 SET

Brake Shoe Hold Down

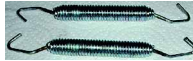


475509 **36-50**
Spring (2 pcs).
(05.046-4)
\$3.00 SET



475506 **36-50**
J-hook (2 pcs).
(05.102-4)
\$3.00 SET

Brake Shoe Return Springs



475511 **37-50**
For 2 wheels (2 pcs) 36-
42 all, 46-50 1/2T, 3/4T
front only. (05.026-4)
\$6.75 SET



3680890 **46-52**
3/4T rear and 1T front.
(05.026-15)
\$8.00 EA

Brake Shoe Springs



3694822 **51-54**
Return & adjusting,
Passenger & 1/2T (does
2 wheels) (6 pcs).
(05.026-3)
\$19.00 SET

Pin-Lock



475508 **36-52**
Brake shoe 9/16in. o.d.
(exc 51-52 1/2T) (2 pcs)
Fits 1 side. (05.030-4)
\$3.00 SET

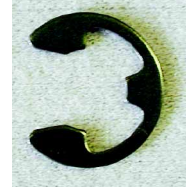


475508E **36-52**
E-clip. Replaces original
on brake shoe. 9/16in.
o.d. (exc 51-52 1/2t) (2
pcs). (05.030-4)
\$1.50 SET



358829 **30-52**
Shoe anchor 29/32in.
o.d. (1/2T & most 3/4T)
(2 pcs). (05.057-15)
\$3.00 SET

Pin-Lock



358829E **30-52**
Replacement (e-clip)
brake shoe, 29/32in.
o.d. (2 pcs). (05.057-4)
\$1.50 SET

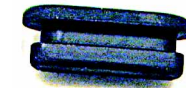


359380 **30-57**
Shoe anchor 1-3/16in.
o.d. some 3/4 & most 1T
(2 pcs). (05.057-2)
\$6.00 EA



359380E **30-57**
Replacement E-clip for
brake shoe, 1-3/16in.
o.d. some 3/4 & most 1T
(2 pcs). (05.057-4)
\$1.50 SET

Brake Adjust Hole Plugs



475516B **36-54**
Plugs (rubber) (8 pcs).
(05.188-4)
\$5.00 SET



475516 **36-54**
Plugs (original metal) (8
pcs). (05.188-4)
\$8.00 SET

Brake Hose



476719 **36-54**
36-50 all, 51-55 Comm, Util (1st Series)
(exc. 1/2-ton), 56-57 Comm, Util (2nd
Series) (exc. H, Series 3-A). Takes 3.
(04.680-2)
\$22.00 EA

3696551 **51-57**
51-54 Pass, 51-57 1/2-ton (Exc. M, Series
3-B) 53-57 Corv., 55-57 Pass. Takes 3.
(04.680-2)
\$22.00 EA

Returns require a return authorization number, please call.

180T: Brake Parts



Format = Part No., Year, Description, original Chevrolet Part Book Group No., Price and Unit Measure.

U-clip



334961 36-57
For brake hose to frame
(uses 3) (3 piece set).
(04.681-4)
\$3.00 SET

Copper Washer



231343 36-57
For brake hose (3 pcs).
(04.671-4)
\$5.00 SET

Brake Line Sets

Oversize shipping charges apply to all Brake Line Sets. Please call for rate.

3696833 **ALL**
Steel 1/2T (specify year when ordering).
(04.865-0)
\$145.00 SET

369683S **ALL**
Stainless 1/2T (specify year when ordering). (04.865-0)
\$170.00 SET

3696844 **37-52**
Steel 3/4T (specify year when ordering).
(04.865-0)
\$145.00 SET

369684S **37-52**
Stainless 3/4T (specify year when ordering). (04.865-0)
\$170.00 SET

Master Cylinder



5450257 36-37
1/2T (\$100 core).
(04.650-15)
\$175.00 EA



5454576E 38-46
New for 1/2T. Must reuse old push rod & retainer. (04.650-15)
\$124.50 EA



5454576 38-46
Rebuilt 1/2T (\$100 core). (04.650-15)
\$115.00 EA



5454381 38-46
Except 1/2T (\$35 core).
(04.650-15)
\$136.00 EA

Master Cylinder



5454575 47-50
1/2T (\$35 core).
(04.650-15)
\$125.00 EA



5454382 47-51
Except 1/2T (\$35 core).
(04.650-15)
\$142.50 EA



5454384 51
1/2T (\$35 core).
(04.650-3)
\$55.00 EA



5454459 52-54
1/2T & 53-54 3/4 & 1T
(exc Hydramatic & Double Duty) (\$35 core). (04.650-15)
\$120.00 EA



5454382 52-54
1-1/2T, 2T & 52 Double Duty (\$35 core).
(04.650-15)
\$142.50 EA

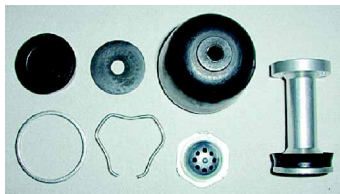


5454384 53-54
Double Duty & Hydramatic (\$35 core).
(04.659-3)
\$55.00 EA

Master Cylinder Rebuild Kit

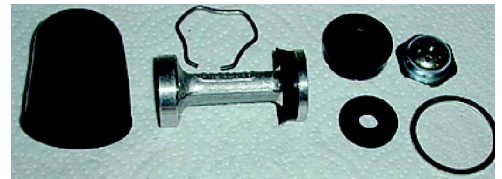


5453950 36-50
1/2T (1in. bore). (04.650-15)
\$18.00 EA



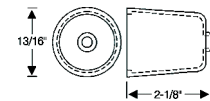
5454428 36-57
1-1/2T, 2T & 36-52 3/4, 1T (1-1/4in. bore).
(04.649-15)
\$28.25 EA

Master Cylinder Rebuild Kit



5450962 51-54
1/2T & 53-54 3/4, 1T (1-1/8in. bore).
(04.649-2)
\$20.00 EA

Rubber Boot



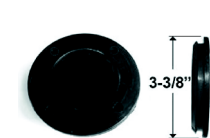
5450551 36-57
On master cylinder.
(04.659-15)
\$14.00 EA

Gasket



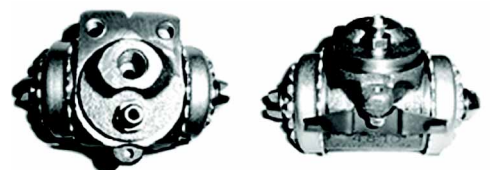
080445 37-57
Master cylinder cap.
(04.651-3)
\$1.50 EA

Plug



592865 36-54
Master cylinder inspection (in floor).
(12.541-3)
\$10.25 EA

Wheel Cylinder-Front



5300869 36-52
36-50 1/2, 3/4, 1, 1-1/2T, 2T & 51-52 3/4T
(exc 50 Double Duty). (04.665-15)
\$67.50 EA

5455479L 51-59
Left 1/2T. (04.665-15)
\$43.25 EA

5455478R 51-59
Right 1/2T. (04.665-15)
\$43.25 EA

5453780 51-52
1-1/2T & 2T. (04.665-15)
\$63.50 EA

180T

Providing part #'s speeds up your order, improves accuracy, and helps us maintain low prices.

See Illustration Index for core charge information and a list of abbreviations. For Body Model information, see 5T. 111



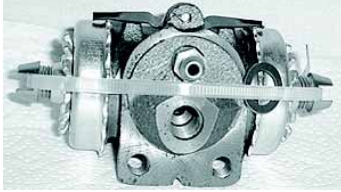
180T: Brake Parts

Format = Part No., Year, Description, original Chevrolet Part Book Group No., Price and Unit Measure.

Wheel Cylinder-Front

5453819 **53-54**
1-1/2T & 2T (1in. piston). (04.665-2)
\$48.00 EA

Wheel Cylinder-Rear



5300866 **36-50**
1/2t, 37-42 3/4T w/ 11in. drum. (04.665-15)
\$40.00 EA

5300885 **36-50**
1-1/2T. (04.665-15)
\$85.00 EA

5450071 **37-52**
1T & 3/4T w/ 14in. drum. (04.665-15)
\$49.50 EA

5453819 **51-54**
Rear (04.665-2)
\$48.00 EA

5455480L **53-57**
Left, 1T. (04.665-4)
\$37.00 EA

5455480R **53-57**
Right, 1T. (04.665-4)
\$37.00 EA

5453866 **51-53**
Front on rear axle (1-1/2T, 2T). (04.665-15)
\$84.00 EA

5453865 **51-53**
Rear on rear axle (1-1/2T, 2T). (04.665-15)
\$81.50 EA

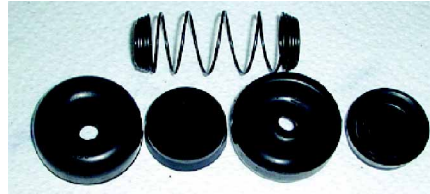
5454313 **53-59**
Front on rear axle (1-1/2T, 2T). (04.665-15)
\$72.00 EA

5454314 **53-59**
Rear on rear axle (1-1/2T, 2T). (04.665-15)
\$67.50 EA

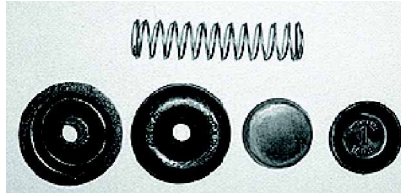
Wheel Cylinder Kit-Front



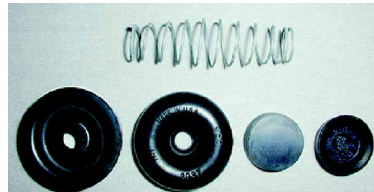
5450431 **36-52**
36-50 1/2, 3/4, 1, 1-1/2T, 2T & 51-52 3/4T
(exc 50 Double Duty) (1-1/4in. bore).
(04.665-15)
\$20.00 EA



5455661 **51-59**
1/2T & 53-57 3/4 & 1T. (1-1/8in. bore).
(04.665-3)
\$9.00 EA

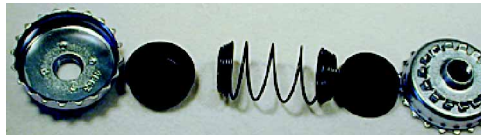


5455660 **53**
1-1/2T & 2T. (04.665-2)
\$8.00 EA



5454399 **54-59**
1-1/2T & 2T. (04.665-3)
\$8.50 EA

Wheel Cylinder Kit-Rear

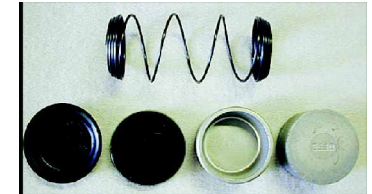


5450429 **36-50**
1/2T & 37-42 3/4T with 11in. drum (1-3/16in. bore). (04.665-15)
\$16.25 EA

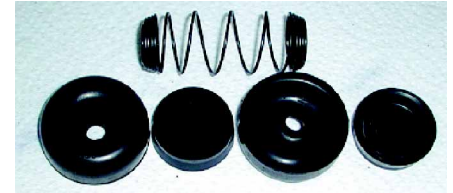
Wheel Cylinder Kit-Rear



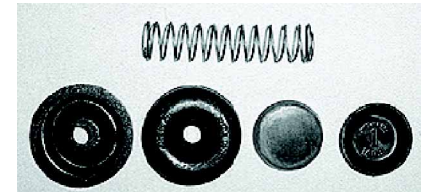
5450435 **36-50**
W/ pistons 1-1/2T & 2T (1-1/2in. bore).
(04.665-2)
\$17.50 EA



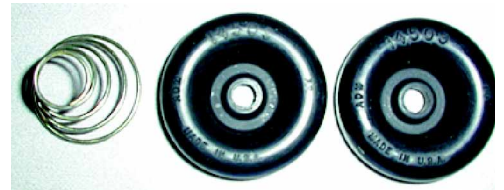
5450434 **36-52**
W/ pistons 3/4T with 14in. drum 40-52 1T
(exc Double Duty) (1-3/8in. bore).
(04.665-2)
\$18.75 EA



5455661 **51-57**
3/4T (exc 56 Double Duty). (04.665-3)
\$9.00 EA



5455660 **51-59**
1/2T (04.665-2)
\$8.00 EA



5454488 **51-57**
1-1/2T & 2T. (04.665-3)
\$13.50 EA

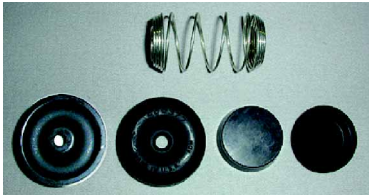
Returns require a return authorization number, please call.

180T: Brake Parts



Format = Part No., Year, Description, original Chevrolet Part Book Group No., Price and Unit Measure.

Wheel Cylinder Kit-Rear



5454252 **53-59**
1T (04.665-3)
\$10.00 EA

Bleeder Valve



5300926 **36-57**
Wheel cylinder.
(04.666-15)
\$1.75 EA

Brake Line Junction Bolt



476099 **37-54**
Brake line junction block bolt. Fits all car and 51-55 3/4 ton up to 2 ton trucks. (4.686-0)
\$2.75 EA

Brake Line Junction Block



497756 **36-57**
Block for rear brake hose at rear axle housing. Fits 1936-50 All, 1951-57 3/4, 1 Ton & Utility. (4.686-15)
\$19.50 EA



3696552 **51-57**
Block for rear brake hose at rear axle housing. Fits 1951-57 ALL & 1/2 Ton. (4.686-15)
\$19.50 EA



476100 **36-50**
Block for rear brake hose at rear axle housing. Fits 1936-50 ALL, 51-57 3/4, 1 Ton & Utility. (4.686-15)
\$18.00 EA

Brake Line Junction Block



3696540 **51-54**
Block, left front brake line at master cylinder. Fits 1951-54 PASS (EXC. CONV) & 1/2 ton. (4.686-15)
\$18.00 EA



3692044 **49-54**
Block front brake line at master cylinder. Also fits 49-54 Convertible. With nut. (4.686-15)
\$23.00 EA

Clip



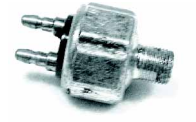
3735074C **ALL**
3/8in. slot, gas, brake line, wire harness (4 pcs). (08.950-4)
\$4.00 SET

148129A **ALL**
Double ended, holds 1/4in. brake & 5/16in. gas line to frame (snaps into hole). (08.950-4)
\$3.00 EA

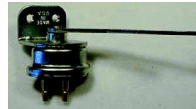
Brake Light Switch



1997725 **36-42**
Hydraulic (41-42 COE only). (02.447-2)
\$12.50 EA



403936
Hydraulic. (02.447-2)
\$8.75 EA



1997901 **42-54**
Mechanical (exc 42 COE). (02.447-2)
\$18.00 EA

Brake Fluid



603486B **ALL**
DOT 5, silicone. Less corrosion. (04.683-15)
\$18.00 QT



5450285B **ALL**
DOT 4 (12 oz). (04.683-15)
\$3.00 EA

Brake Cleaner



6129423 **ALL**
Superior cleaner. Many uses (spray can). (04.683-2)
\$3.00 EA

180T

Providing part #'s speeds up your order, improves accuracy, and helps us maintain low prices.

See Illustration Index for core charge information and a list of abbreviations. For Body Model information, see 5T. 113



180T: Brake Parts

Format = Part No., Year, Description, original Chevrolet Part Book Group No., Price and Unit Measure.

Odds & Ends

Please call for availability on all Odds & Ends parts; once part is sold, it may no longer be in stock.

- 3693452 51-55**
Brake backing plate right side (05.001-0)
\$34.00 EA.
- 3693451 51-55**
Backing Plate, Rear Left fits 51-54 Passenger, 53-55 Corvette, 51-55 1/2 ton (1st series) (05.001-0)
\$35.00 EA.
- 7450131 49-53**
Front inner bearing, 49-50 2 ton (13*000-3)
\$45.00 EA
- 3680959U 46**
Brake cable 46 3/4 (Used) (4.826-0)
\$25.00 EA
- 477443U 36-50**
Brake link small pin & spring used fits 1936-50 passenger car & 1946-50 1/2 ton & 3/4 ton exc DD (05.029-0)
\$5.00 PR
- 592412U 36-52**
Brake links used (fits 1936-50 passenger, 1936-42 truck, 1946-50 1/2 ton, 3/4 ton exc DD, 1951-52 3/4 ton exc DD) (05.036-0)
\$20.00 PR
- 3653268U 40-52**
Clevis. Fits 40-52 Pass, 55-59 3/4, 1 & 1.5 Ton w/ HT, 3spd, HD & 2nd series (Used) (04.826-0)
\$10.00 EA
- 378548 34-57**
Deflector, Rear Wheel Hub NOS (14*000-0)
\$8.00 EA.
- 3684247 47-52**
Emergency brake cable 1 ton NOS (14*000-0)
\$60.00 EA
- 91949 55-59**
Emergency Brake Cable (55-59 1/2T) (14*000-0)
\$40.00 EA
- 3651404 39-46**
Emergency brake cable. Fits all Utility. (14^000-0)
\$60.00 EA
- 3686685 48-50**
Emergency Brake cable (Utility) (14*000-0)
\$45.00 EA

Odds & Ends

- 3658405 37-42**
Emergency brake cables, 37-38 3/4T (14^000-0)
\$45.00 EA
- 596565 37-50**
Bolt, flange plate spacer fits 1937-52 Utility Exc COE, HD or 1946-50 1-1/2T except school bus chassis (05.002-0)
\$15.00 PR
- 3687294 52-55**
Foot brake pedal latch bar, COMM NOS (14*000-0)
\$17.50 EA
- 597235 39**
Front anchor plate & links. (05.075-0)
\$40.00 EA
- 144526 36-40**
Inner Race & Roller outer axle bearing (13*000-0)
\$25.00 EA
- 370957 29-38**
Oil Deflector, Front Hub, Straight (14*000-0)
\$6.00 EA
- 3656987U 40-57**
Pedal assembly brake and clutch (02.008-0)
\$25.00 EA
- 592420U 36-50**
Pin for brake link used (05.036-0)
\$15.00 EA
- 3695834 51-57**
Propeller shaft dual shoe brake link outer connecting angle on one end fits 51-55 1 ton utility first series except COE, 55-57 2nd series all (05.610-0)
\$15.00 EA
- 3650735 39-48**
Seal - wheel bearing front fits 39 COE, 40-48 2 Ton & 46-48 school bus chassis (06.326-0)
\$10.00 EA
- 5300890 36-50**
Wheel brake cylinder cup 1-1/2in. rear (4.665-0)
\$0.50 EA
- 1409123 36**
Wheel brake cylinder cup rear 1-1/16in. (4.665-0)
\$0.50 EA

Odds & Ends

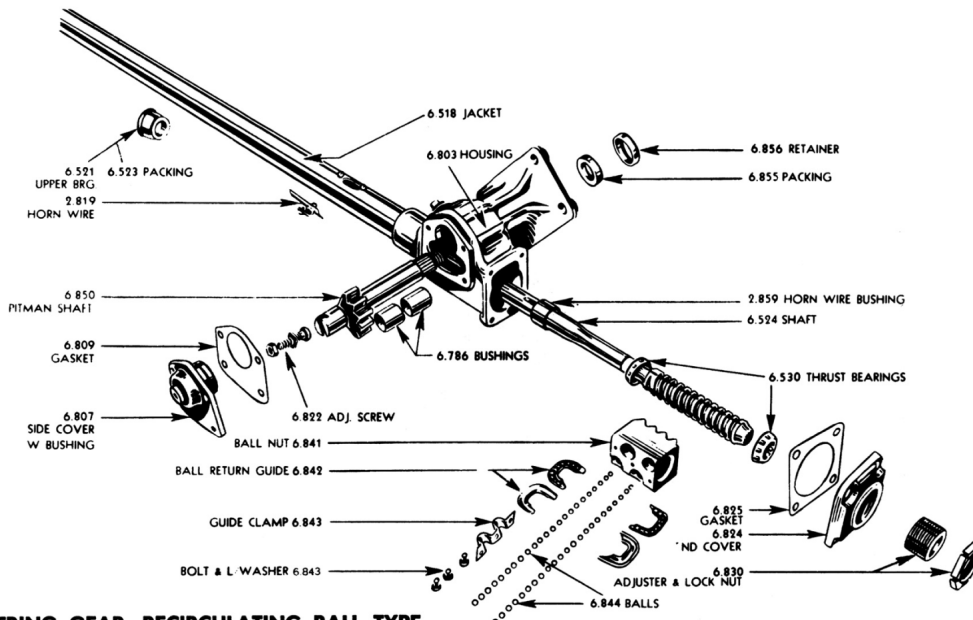
- 5450031 51-59**
Wheel brake cylinder cups. Fits 51-52 and 53-59 CBL (4.665-0)
\$0.50 EA
- 5450073 46-50**
Wheel brake cylinder cups front 1-3/8in. (4.665-0)
\$0.50 EA
- 5465299 53**
Wheel brake cylinder. Front 1in. (4.665-0)
\$0.50 EA
- 5451615-1 46-48**
Wheel brake cylinder rear (4.665-0)
\$19.00 EA
- 5300885N 36-50**
Wheel brake cylinder rear NOS 1.5 ton (04.665-0)
\$85.00 EA
- 1074825 36-50**
Wheel brake cylinders front 1-3/16in. (4.665-0)
\$0.50 EA
- 5300922 36-50**
Wheel Cylinder Adjust Screw Rear (Utility) (04.672-0)
\$3.00 EA
- 5300800 ALL**
Wheel cylinder cup 1-3/16 in (04.667-0)
\$2.00 EA
- 5300866U 54-60**
Wheel cylinder NOS shelf worn (04.665-0)
\$50.00 EA
- 5455484N 53-57**
Wheel cylinder rear 1 ton DD (14~000-0)
\$55.00 EA
- 5450431N 36-48**
Wheel brake cylinder spring & cups. Front for 1-1/4in. bore, Delco NOS. (04.665-0)
\$15.00 SET
- 5455480 53-57**
Wheel cylinder rear 3/4 ton (04.665-0)
\$40.75 EA

Returns require a return authorization number, please call.

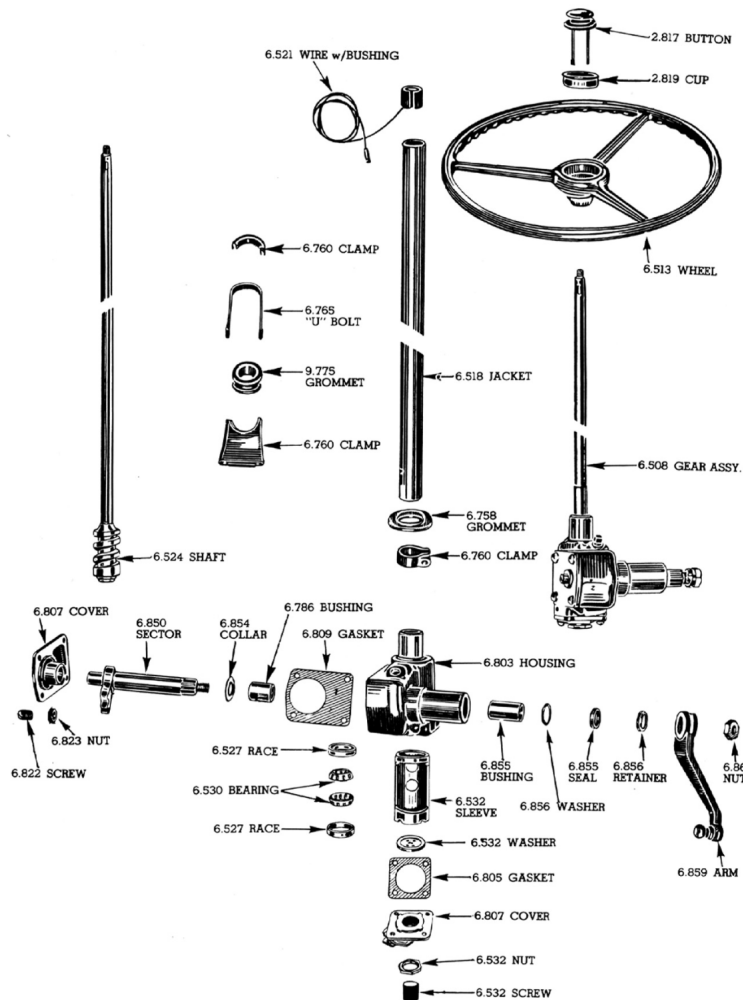
190T: Steering Components & Related



Format = Part No., Year, Description, original Chevrolet Part Book Group No., Price and Unit Measure.



1941-46 STEERING GEAR—RECIRCULATING BALL TYPE



1937-40 TRUCK AND 1937 GB SERIES PASSENGER CAR

190T

Providing part #'s speeds up your order, improves accuracy, and helps us maintain low prices.

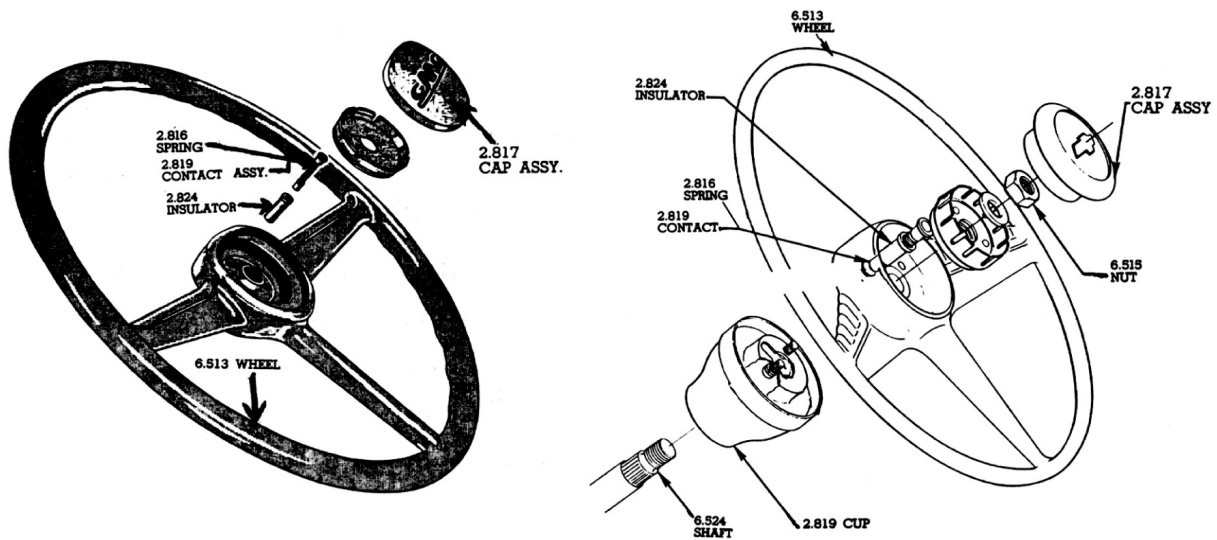
See Illustration Index for core charge information and a list of abbreviations. For Body Model information, see 5T. 115



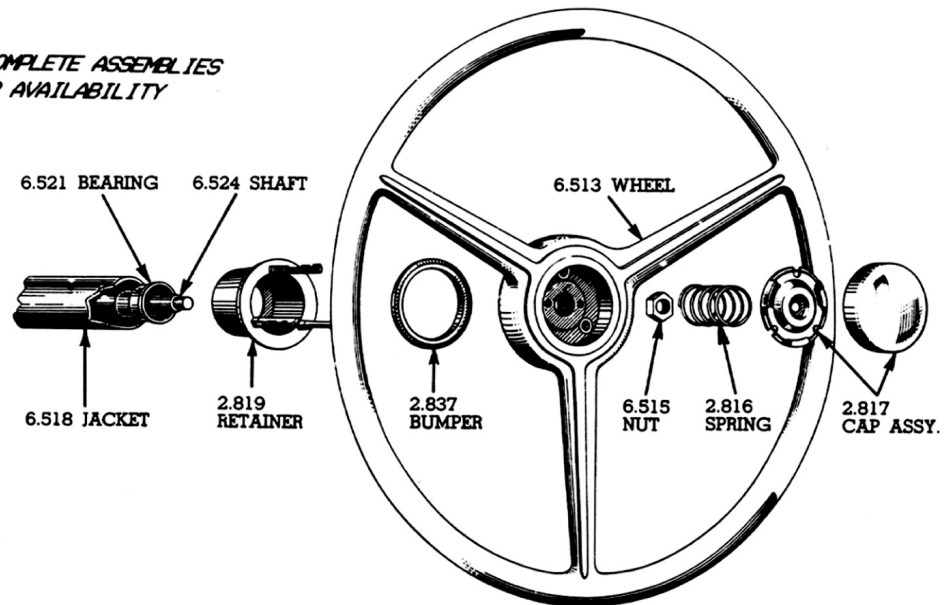
190T: Steering Components & Related

Format = Part No., Year, Description, original Chevrolet Part Book Group No., Price and Unit Measure.

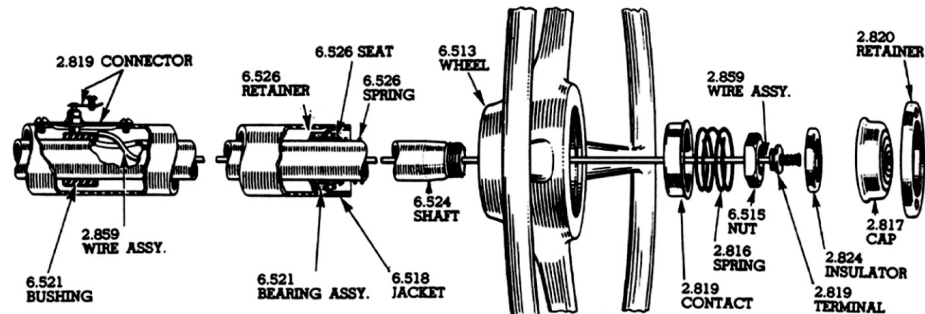
HORN CONTACT PARTS



ILLUSTRATIONS ARE COMPLETE ASSEMBLIES
SEE TEXT FOR AVAILABILITY



HORN CONTACT PARTS—CONVENTIONAL TRUCK



HORN CONTACT PARTS—CAB-OVER-ENGINE

Returns require a return authorization number, please call.

190T: Steering Components & Related



Format = Part No., Year, Description, original Chevrolet Part Book Group No., Price and Unit Measure.

Street Rod Parts

Telescopic (Power) & Tilt Steering Column (Flaming River)

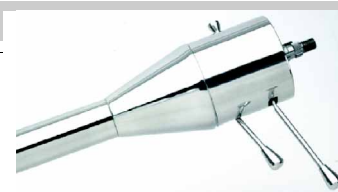
Power Telescopic and Tilt column in one package. Full 2 inch range of travel. Unique design telescopes from the tube with a remote, compact stainless steel cable drive which can be mounted under the dash, seat or anywhere you can think to hide it (72" cable length). You can even add 2-position memory control at a minimal cost. Easy to install, complete functionality. Available for floor shift applications only. Order in mill finish (paintable) or polished stainless.



FR20011PM	ALL	30-32in., Polished Stainless Finish. W/ memory control. (04.007-0)	\$1,550.00	EA
FR20012PM	ALL	32-34in., Polished Stainless Finish. W/ memory control. (04.007-0)	\$1,550.00	EA
FR20011P	ALL	30-32in., Polished Stainless Finish. (04.007-0)	\$1,390.50	EA
FR20012P	ALL	32-34in., Polished Stainless Finish. (04.007-0)	\$1,390.50	EA
FR20011M	ALL	30-32in., Mill Finish. (04.007-0)	\$1,133.00	EA
FR20012M	ALL	32-34in., Mill Finish. (04.007-0)	\$1,133.00	EA

Tilt Steering Column-Floor Shift (Flaming River)

Flaming River now manufactures an all new column shift, tilt steering column. All new components have been engineered by Flaming River incorporating state-of-the-art technology in this nostalgic design. Each column comes complete with gear shift arm, stainless steel dress up kit, illuminated gearshift indicator and GM wiring (4-1/4in. connector) and a removable 12 position linkage arm. Shaft size=1in. DD, 2in. tube diameter.



FR20000	ALL	1-3/4in. o.d. x 28in. length. Steel finish (paintable). (04.007-15)	\$329.00	EA
FR20000SS	ALL	1-3/4in. o.d. x 28in. length. Polished, stainless steel finish. (04.007-15)	\$479.00	EA
FR20001	ALL	1-3/4in. o.d. x 30in. length. Steel finish (paintable). (04.007-15)	\$329.00	EA
FR20001SS	ALL	1-3/4in. o.d. x 30in. length. Polished, stainless steel finish. (04.007-15)	\$479.00	EA
FR20005-28	ALL	2in. o.d. x 28in. length. Steel finish (paintable). (04.007-15)	\$329.00	EA
FR20005-28SS	ALL	2in. o.d. x 28in. length. Polished, stainless steel finish. (04.007-15)	\$483.25	EA
FR20005	ALL	2in. o.d. x 30in. length. Steel finish (paintable). (04.007-15)	\$329.00	EA
FR20005SS	ALL	2in. o.d. x 30in. length. Polished, stainless steel finish. (04.007-15)	\$479.00	EA
FR2000MCSS	ALL	Polished Stainless. Since it is only 17" long, it reduces u-joint angles and removes visible tube from the engine compartment increasing component clearance. (04.007-15)	\$384.00	EA

Tilt Steering Column-Column Shift (Flaming River)

Flaming River now manufactures an all new column shift, tilt steering column. All new components have been engineered by Flaming River to incorporate state-of-the-art technology in this nostalgic design. Each column comes complete with gear shift arm, stainless steel dress up kit, illuminated gearshift indicator and GM wiring (4-1/4in. connector) and a removable 12 position linkage arm with each column for easy alignment. Shaft size is 1in. DD 2i. tube diameter.



FR20020	ALL	2in. o.d. x 28in. length. Steel finish (paintable). (04.007-0)	\$534.75	EA
FR20020PL	ALL	2in. o.d. x 28in. length. Chrome & stainless steel finish. (04.007-15)	\$664.50	EA
FR20021	ALL	2in. o.d. x 30in. length. Steel finish (paintable). (04.007-0)	\$534.75	EA
FR20021PL	ALL	2in. o.d. x 30in. length. Chrome & stainless steel finish. (04.007-15)	\$664.50	EA
FR20111NS	ALL	Concealed neutral safety switch, can be installed on you gear shift column. Includes switch & billet aluminum cover. (04.007-15)	\$36.00	EA

190T

Providing part #'s speeds up your order, improves accuracy, and helps us maintain low prices.

See Illustration Index for core charge information and a list of abbreviations. For Body Model information, see 5T. 117

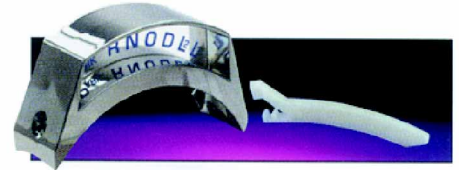


190T: Steering Components & Related

Format = Part No., Year, Description, original Chevrolet Part Book Group No., Price and Unit Measure.

Shift Indicator (Flaming River)

FR20010-KIT	ALL	Black ABS housing w/ pointer. (04.007-15)\$69.00	EA
LFR20010-OVKIT	ALL	Black ABS overdrive housing w/ pointer. (04.007-15)\$69.00	EA
FR20010-KITC	ALL	Chrome ABS housing w/ pointer. (04.007-15)\$95.00	EA
FR20010-OVKITC	ALL	Chrome ABS overdrive housing w/ pointer. (04.007-15)\$95.00	EA



Gearshift Arm (Flaming River)

This 12-Position Shifter Arm makes it easier to line up and adjust your transmission linkage. It is also removable to minimize the hole in the floorboard. Straight arm included free with each gearshift column.



FRGSARM	ALL	Straight gearshift arm. (04.038-15)\$29.00	EA
---------	-----	-------------------------------------	--------------	----



FRGSARM-OF	ALL	Offset gearshift arm. (04.038-15)\$29.00	EA
------------	-----	-----------------------------------	--------------	----

Steering Column Drop



BIS27025	ALL	2-1/2in. drop for 2" column, POLISHED finish. Billet Specialties. (06.761-15)\$60.00	EA
----------	-----	---	--------------	----

Flaming River's Column Drops are machined from billet aluminum with a smooth radius edge. This sleek design is available in satin or mirror finish.



FR20102	ALL	2-1/2in. drop for 1-3/4in. column, satin finish. (06.761-15)\$82.25	EA
FR20102PL	ALL	2-1/2in. drop for 1-3/4in. column, polished finish. (06.761-15)\$91.75	EA
FR20107	ALL	2-1/2in. drop for 2in. column, satin finish. (06.761-15)\$82.25	EA
FR20107PL	ALL	2-1/2in. drop for 2in. column, polished finish. (06.761-15)\$91.75	EA
FR20103	ALL	3-1/2in. drop for 1-3/4in. column, satin finish. (06.761-15)\$82.25	EA
FR20103PL	ALL	3-1/2in. drop for 1-3/4in. column, polished finish. (06.761-15)\$91.75	EA
FR20108	ALL	3-1/2in. drop for 2in. column, satin finish. (06.761-15)\$82.25	EA
FR20108PL	ALL	3-1/2in. drop for 2in. column, polished finish. (06.761-15)\$91.75	EA

Column Floor Mounts



BIS27920	ALL	1-7/8" column MOUNT FLOOR. Billet Specialties. (06.758-15)\$60.00	EA
----------	-----	--	--------------	----

Billet aluminum ball and collar swivel design floor mount simplifies column installation by allowing up to a 60 degree angle.



FR20100	ALL	1-3/4in. floor shift. Flaming River. (06.758-15)\$82.25	EA
FR20101	ALL	2in. column shift. Flaming River. (06.758-15)\$82.25	EA

Returns require a return authorization number, please call.

190T: Steering Components & Related



Format = Part No., Year, Description, original Chevrolet Part Book Group No., Price and Unit Measure.

Column Floor Mounts



FR20100CVR	ALL	Floor mount firewall cover. Polished aluminum cover to finish the engine side column of the floor mount. Flaming River. (06.758-15)	\$46.50	EA
------------	-----	---	---------	----

Tilt Column Wiring Accessories (Flaming River)



FR20118-2	ALL	Plug adapter-horseshoe shaped connector used in 67-68 Camaro. (Plug adapter FR20118 could be used in place of this adapter). (02.555-15)	\$40.25	EA
-----------	-----	--	---------	----



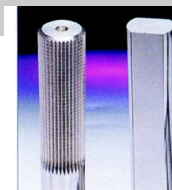
FR20118-1	ALL	Flasher kit used for classic vehicles that did not come equipped with 4-ways. Includes flasher, female adapter & terminals. (02.555-15)	\$71.25	EA
-----------	-----	---	---------	----



FR20118	ALL	Plug adapter kit, female plug. Supplied with terminals. Can be used to adapt any existing wiring harness to mate with 4-1/4in. connector. (02.555-15)	\$15.50	EA
---------	-----	---	---------	----

Steering Shaft-Billet (Flaming River)

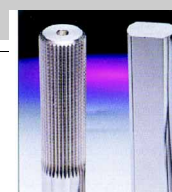
FR1870-X	ALL	Splined shaft in 2in. increments (4in. to 16in.) unplated. (05.548-15)	\$35.50	EA
FR1870-XPL	ALL	Splined shaft in 2in. increments (4in. to 16in.) plated. (05.548-15)	\$59.50	EA
FR1871-XX	ALL	Splined shaft in 2in. increments (18in. to 22in.) unplated. (05.548-0)	\$39.50	EA
FR1871-XXPL	ALL	Splined shaft in 2in. increments (18in. to 22in.) plated. (05.548-15)	\$59.50	EA
FR1850	ALL	DD 18in. shaft, unplated. (05.548-15).....	\$31.00	EA
FR1851	ALL	DD 36in. shaft, unplated. (05.548-15).....	\$50.00	EA



Steering Shaft-Stainless (Flaming River)

Stainless Steel shafts are manufactured from high quality 303 stainless.

FR1850SSPL	ALL	Polished stainless steel shafts, 18in. DD. (05.548-15)	\$70.00	EA
FR1851SSPL	ALL	Polished stainless steel shafts, 36in. DD. (05.548-15)	\$89.00	EA
FR1870-XSS	ALL	Polished stainless steel shafts splined in 2in. increments (4in. to 16in.). (05.548-15).....	\$102.50	EA
FR1871-XXSS	ALL	Polished stainless steel shafts splined in 2in. increments (18in. to 22in.)(05.548-15).....	\$102.50	EA



U-joints--Billet-Joint Steering Box (Flaming River)

The Billet-Joint U-Joints are CNC machined from aircraft steel to precision tolerances. The sealed needle bearing design will last ten times longer than a standard pin & block universal joint. The unique nickel plating prevents rust without the hassle of painting.

FR1709DD	ALL	9/16in. -26 spline box, 3/4in. DD shaft. (05.548-15)	\$71.50	EA
FR1709DDPL	ALL	9/16in. -26 spline box, 3/4in. DD shaft (polished). (05.548-15)	\$91.50	EA
FR1708	ALL	9/16in. -26 spline box, 3/4in. -36 shaft. (05.548-15)	\$71.50	EA
FR1708PL	ALL	9/16in. -26 spline box, 3/4in. -36 shaft (polished) (05.548-15)	\$91.50	EA
FR1722DD	ALL	5/8in. -36 spline box, 3/4in. DD shaft. (05.548-15)	\$71.50	EA
FR1722DDPL	ALL	5/8in. -36 spline box, 3/4in. DD shaft (polished). (05.548-15)	\$91.50	EA
FR1726DD	ALL	5/8in. -36 spline box, 3/4in. -36 shaft. (05.548-15)	\$71.50	EA
FR1726DDPL	ALL	5/8in. -36 spline box 3/4in. -36 shaft (polished). (05.548-15)	\$91.50	EA
FR1724	ALL	3/4in. -30 spline box, 3/4in. -36 shaft. (05.548-15)	\$71.50	EA



Providing part #'s speeds up your order, improves accuracy, and helps us maintain low prices.

See Illustration Index for core charge information and a list of abbreviations. For Body Model information, see 5T. 119



190T: Steering Components & Related

Format = Part No., Year, Description, original Chevrolet Part Book Group No., Price and Unit Measure.

U-joints--Billet-Joint Steering Box (Flaming River)

FR1724PL	ALL	3/4in. -30 spline box, 3/4in. -36 shaft (polished) (05.548-15)	\$91.50	EA
FR1733DD	ALL	3/4in. -30 spline box, 3/4in. DD shaft. (05.548-15)	\$71.50	EA
FR1733DDPL	ALL	3/4in. -30 spline box, 3/4in. DD shaft (polished).(05.548-15)	\$91.50	EA
FR1715DD	ALL	3/4in. -36 spline box, 3/4in. DD shaft. (05.548-15)	\$71.50	EA
FR1715DDPL	ALL	3/4in. -36 spline box, 3/4in. DD shaft (polished). (05.548-15)	\$91.50	EA
FR1711	ALL	3/4in. -36 spline box, 3/4in. -36 shaft. (05.548-15)	\$71.50	EA
FR1711PL	ALL	3/4in. -36 spline box, 3/4in. -36 shaft (polished).	\$91.50	EA

U-joints--Billet-Joint Steering Column (Flaming River)

FR1707DD	ALL	1in. DD column, 3/4in. Shaft. (05.548-15)	\$71.50	EA
FR1707DDPL	ALL	1in. DD column, 3/4in. shaft (polished). (05.548-15)	\$91.50	EA
FR1746DD	ALL	1in. DD column, 3/4in. -30 shaft. (05.548-15)	\$71.50	EA
FR1746DDPL	ALL	1in. DD column, 3/4in. -30 shaft (polished) (05.548-15)	\$91.50	EA
FR1714DD	ALL	1in. DD column, 3/4in. -36 shaft. (05.548-15)	\$71.50	EA
FR1714DDPL	ALL	1in. DD column, 3/4in. -36 shaft (polished).(05.548-15)	\$91.50	EA
FR1717DD	ALL	1in. DD column, 3/4in. DD shaft. (05.548-15)	\$71.50	EA
FR1717DDPL	ALL	1in. DD column, 3/4in. DD shaft (polished)	\$91.50	EA
FR1754DD	ALL	1in. DD column, 1in. DD shaft. (05.548-15)	\$71.50	EA
FR1754DDPL	ALL	1in. DD column, 1in. DD shaft (polished).(05.548-15)	\$91.50	EA

U-joints--Stainless Steering Box (Flaming River)

Flaming Rivers Stainless Steel U-joints are made with 303 Stainless Steel for its strength, superior corrosion resistance & shine. The stainless steel joints have such a precision machined finish that they look pretty right out of the box. Add some polishing & they are gorgeous!



FR2509DD	ALL	9/16in. -26 spline box, 3/4in. DD shaft. (05.548-15)	\$80.00	EA
FR2509DDPL	ALL	9/16in. -26 spline box, 3/4in. DD shaft (polished).(05.548-15)	\$100.00	EA
FR2508	ALL	9/16in. -26 spline box, 3/4in. -36 splined shaft.(05.548-15)	\$80.00	EA
FR2508PL	ALL	9/16in. -26 spline box, 3/4in. -36 splined shaft (polished).(05.548-15)	\$100.00	EA
FR2522DD	ALL	5/8in. -36 spline box, 3/4in. DD shaft. (05.548-15)	\$80.00	EA
FR2522DDPL	ALL	5/8in. -36 spline box, 3/4in. DD shaft (polished).	\$100.00	EA
FR2526	ALL	5/8in. -36 splined shaft box, 3/4in. -36 splined shaft (05.548-15)	\$80.00	EA
FR2526PL	ALL	5/8in. -36 splined shaft box, 3/4in. -36 splined shaft (polished) (05.548-15)	\$100.00	EA
FR2533DD	ALL	3/4in. -30 spline box, 3/4in. DD shaft. (05.548-15)	\$80.00	EA
FR2533DDPL	ALL	3/4in. -30 spline box, 3/4in. DD shaft (polished). (05.548-15)	\$100.00	EA
FR2524	ALL	3/4in. -30 spline box, 3/4in. -36 splined shaft. (05.548-15)	\$80.00	EA
FR2525PL	ALL	3/4in. -30 spline box, 3/4in. -36 splined shaft (polished). (05.548-15)	\$100.00	EA
FR2515DD	ALL	3/4in. -36 spline box, 3/4in. DD shaft. (05.548-15)	\$80.00	EA
FR2515DDPL	ALL	3/4in. -36 spline box, 3/4in. DD shaft (polished). (05.548-15)	\$100.00	EA
FR2511	ALL	3/4in. -36 spline box, 3/4in. -36 splined shaft. (05.548-15)	\$80.00	EA
FR2511PL	ALL	3/4in. -36 spline box, 3/4in. -36 splined shaft (polished). (05.548-15)	\$100.00	EA

U-joints Stainless Steering Column (Flaming River)

FR1716DD	ALL	3/4" DD column, 3/4in. DD shaft. (05.548-15)	\$71.50	EA
FR2514DD	ALL	1in. DD column, 3/4in. -36 splined shaft.(05.548-15)	\$80.00	EA
FR2514DDPL	ALL	1in. DD column, 3/4in. -36 splined shaft (polished) (05.548-15)	\$100.00	EA
FR2517DD	ALL	1in. DD column, 3/4in. DD shaft. (05.548-15)	\$80.00	EA
FR2517DDPL	ALL	1in. DD column, 3/4in. DD shaft (polished). (05.548-15)	\$100.00	EA



Returns require a return authorization number, please call.

190T: Steering Components & Related



Format = Part No., Year, Description, original Chevrolet Part Book Group No., Price and Unit Measure.

Restoration Parts

Steering Shaft Support Bearing



FR1810ALL
3/4in., zinc plated for steering systems with multiple joints. Fits splined or DD shafts. (05.548-0)
\$29.00 EA

Steering Wheel



756084A 47-53
Black. Superior quality. (06.513-15)
\$200.00 EA



758625A 54
Black. Superior quality. (06.513-15)
\$200.00 EA

Insulator



3681057A 34-46
Steering column to dash, brown exc COE. (06.758-15)
\$11.50 EA



598145 34-46
Steering column to dash, black exc COE. (06.758-15)
\$1.75 EA



3685524 47-53
Steering column to dash, black exc COE. (06.758-15)
\$2.50 EA



3700190 54
Steering column to dash. (06.758-15)
\$3.00 EA

Grommet



357507..... 29-46
Steering column at floor (exc COE). (06.758-15)
\$29.75 EA



3685928..... 47-54
Steering column with metal core & sponge seal #3682871 at firewall (floor shift). (06.758-15)
\$13.00 EA



3685928A 47-54
Steering column without metal core at firewall (floor shift). (06.758 -15)
\$16.50 EA



3687204..... 47-54
Steering column at firewall (column shift). (06.758-3)
\$5.50 EA



3682871..... 47-54
Steering column at firewall (floor shift). (06.758-2)
\$4.00 EA



3687205..... 48-54
Steering column with metal core & sponge seal #3687204 at firewall (column shift). (06.758-15)
\$16.00 EA

Rubber Ring



755899..... 41-46
Anti-rattle under steering wheel. (02.819-3)
\$7.25 EA

Bearing



264887..... 41-46
Under steering wheel. (06.521-15)
\$15.50 EA

Bearing



270255 47-54
Under steering wheel. (06.521-15)
\$60.00 EA

Steering Gear Overhaul Kit

Note: Steering gear overhaul kits do not include worm gear, pitman shaft or sector shaft. Those items sold separately.



264277A 38-40
Includes roller bearings. (06.524-15)
\$75.50 KIT



267880A 41
(06.524-15)
\$111.25 KIT



267880B 42-46
Exc 1T & larger COE. (06.524-15)
\$113.00 KIT



5060231A 47-54
(06.524-15)
\$127.50 SET

Bearings & Balls For Steering Worm Gear



266741 41
Balls in ball nut steering worm gear (30 piece). (06.844-4)
\$10.00 SET



206800 42-57
Balls in ball nut steering worm gear (30 piece). (06.844-4)
\$8.00 SET

190T

Providing part #'s speeds up your order, improves accuracy, and helps us maintain low prices.

See Illustration Index for core charge information and a list of abbreviations. For Body Model information, see 5T. 121



190T: Steering Components & Related

Format = Part No., Year, Description, original Chevrolet Part Book Group No., Price and Unit Measure.

Bearings & Balls For Steering Worm Gear



261866B.....37-40
Thrust bearing (2) & race (2). (06.530-15)
\$37.00 SET



179291B.....41-54
Thrust bearing (2) & race (2). (06.530-15)
\$70.00 SET

Gasket



269298.....41-46
Steering gear side cover. (06.809-3)
\$2.50 EA

Pitman Shaft



609936.....38-40
Steering gear. (06.850-3)
\$85.00 EA

Screw



266678.....41-57
Adjuster for pitman shaft. (06.822-15)
\$7.25 EA

Bushing-Pitman Shaft



266316.....34-54
Pitman shaft. (06.786-15)
\$17.25 EA

Pitman Shaft Seal



262155.....37-57
(06.855-15)
\$7.00 EA

Drag Link Kit



608840.....32-59
Tie rod end rebuild kit, plugs, springs, seats, exc 53-59 drag link. (06.874-15)
\$26.50 PR

Drag Link Rebuild Kit



608840N.....32-40
NOS. Includes plugs, springs & seats (exc 39-48 knee action). (06.874-4)
\$35.00 PR

Drag Link



609749.....37-46
Fits 37-46 1/2, 3/4, 1 and 1-1/2 ton vehicles. Includes part #608840 (Tie rod end rebuild kit). (06.870-15)
\$89.50 EA



3699489.....47-52
Includes Drag Link Kit #608840 (Tie rod end rebuild kit). (06.870-15)
\$100.00 EA



3696469.....53-54
With tie rod ends. (06.870-15)
\$86.75 EA

Balls



595586B.....30-59
Drag link end on steer & pitman arms. (06.874-15)
\$47.00 SET



595586A.....30-52
Tie rod end on 1/2T steering arms (2 pcs). (06.874-3)
\$42.00 SET

Drag Link Seals



3705009A.....32-52
2-7/8in. long, metal as original. (06.886-4)
\$17.25 SET



3705009.....32-52
2-1/4in. long, rubber replacement. (06.886-3)
\$17.75 SET

Long Tie Rod



367528.....32-54
Rod only (40-54 1/2T & 3/4T). (06.230-15)
\$40.00 EA

Tie Rod End



374226R.....34-54
1/2T & 3/4T (replacement type complete w/ ball) right. (06.233-15)
\$36.00 EA

374227L.....34-54
1/2T & 3/4T (replacement type complete with ball), left. (06.233-15)
\$36.00 EA

Returns require a return authorization number, please call.

190T: Steering Components & Related



Format = Part No., Year, Description, original Chevrolet Part Book Group No., Price and Unit Measure.

Caster Adjusting Wedges



- 474682** **ALL**
Beam axle, 2 degree (aluminum). (7.425-4)
\$10.50 PR
- 474682D** **ALL**
Beam axle, 2 1/2 degree (aluminum).
(07.425-4)
\$10.50 SET
- 474682E** **ALL**
Beam axle, 3 degree (aluminum).
(07.425-3)
\$10.50 SET
- 474682F** **ALL**
Beam axle, 3 1/2 degree (aluminum).
(07.425-2)
\$10.50 SET
- 474682A** **ALL**
Beam axle, 4 degree (aluminum).
(07.425-4)
\$10.50 SET

Odds & Ends

Please call for availability on all Odds & Ends parts; once part is sold, it may no longer be in stock.

- 596575U** **46**
3rd arm (steering) fits DR, DS, OR, OS, PK
(06.103-0)
\$40.00 EA
- 266667** **41**
Ball nut for steering gear, fits all
commercial & utility exc COE (15*000-0)
\$45.00 EA
- 270263** **47-53**
Ball Nut, Steering Worm Gear (2 Ton)
(15*000-0)
\$45.00 EA
- 08420** **34**
Bushing, Pitman Shaft (NOS) (15-0)
\$4.00 PR
- 3686831** **48-54**
Column shift clamp. All 3-speed.
(12*000-0)
\$12.00 EA

Odds & Ends

- 3835580U** **50-55**
Exhaust manifold. Casting # 3835580
(Used) (03.601-0)
\$75.00 EA
- 266048N** **41**
Guide steering gear ball return fits all
commercial & utility exc COE (15<000-0)
\$15.00 PR
- 756190** **47-53**
Horn button. Fits comm (2.817-0)
\$35.00 EA
- 755850U** **47-53**
Horn Cap Used (04-000-0)
\$15.00 EA
- 1116775** **34-54**
Horn Relay (NOS) (2.815-0)
\$30.00 EA
- 595271U 39-46** **39-46**
Pitman arm (Used) (6.859-0)
\$75.00 EA
- 609937** **41-46**
Pitman Shaft (Steering Gear) (06.850-0)
\$85.00 EA
- 609936N** **38-40**
Pitman Shaft (NOS). Some surface rust.
(06.850-0)
\$85.00 EA
- 3847342** **47-54**
Sector (Pitman Shaft) (06.850-0)
\$85.00 EA
- 3667227** **37-50**
Steering arm fits 1-1/2 ton left or right
(06.103-0)
\$25.00 EA
- 373781** **34-36**
Steering connecting rod (drag link)
(06.870-0)
\$75.00 EA
- 3703563** **53-57**
Steering knuckle (spindle) fits 3/4T & 1T
(15*000-0)
\$65.00 EA
- 607317** **35-37**
Steering Knuckle Spindle (Utility)
(15^000-0)
\$75.00 EA
- 3656527** **41-50**
Steering knuckle stop NOS 1/2T
(15^000-0)
\$20.00 EA

Odds & Ends

- 3678194** **46-50**
Steering knuckle stop NOS (fits 46 PP, PR,
PS; 47-50 DD, SBC & 2T) use with
3681101 forged I-beam (06.009-0)
\$15.00 EA
- 753325** **38-40**
Steering wheel fits all except JA, KA, KB,
KH & COE (Used) (06.513-0)
\$100.00 EA
- 3701357U** **54-57**
Steering wheel hub without single level
hole used (06.512-0)
\$20.00 EA
- 756084U** **47-53**
Steering Wheel Used (04-000-0)
\$70.00 EA
- 374227N** **32-56**
Tie rod end. Left side. (4-59/64in.) (25/36-
16 left hand thread) Stamped L. Fits 32-34
all exc CC & DC, 35-38 Pass, COMM exc
EC, FC, GB & HB, 39-42 COMM, 46-56
1/2T & 3/4T exc DD. (06.233-0)
\$35.00 EA
- 374226N** **32-56**
Tie rod end left (4-59/64 in) (25/36-16 right
hand thread) Stamped R. Fits 32-34 all exc
CC & DC, 35-38 Pass, COMM exc EC, FC,
GB & HB, 39-42 COMM, 46-56 1/2T & 3/4T
exc DD. (06.233-0)
\$35.00 EA
- 267880** **41-46**
Worm Gear & Shaft (06.850-0)
\$125.00 EA
- 270260** **47-53**
Worm Gear & Shaft 2T & School Bus
Chassis (15^000-0)
\$125.00 EA
- 5660219** **49-50**
Worm Gear & Shaft (50 1st Design)
(06.524-0)
\$150.00 EA
- 264279** **38-40**
Worm Gear & Shaft (All Utility) (06.524-0)
\$150.00 EA
- 267888** **41-46**
Worm Gear & Shaft Utility exc COE
(15^000-0)
\$150.00 EA

190T

Providing part #'s speeds up your order, improves accuracy, and helps us maintain low prices.

See Illustration Index for core charge information and a list of abbreviations. For Body Model information, see 5T. 123



190T: Steering Components & Related

Format = Part No., Year, Description, original Chevrolet Part Book Group No., Price and Unit Measure.



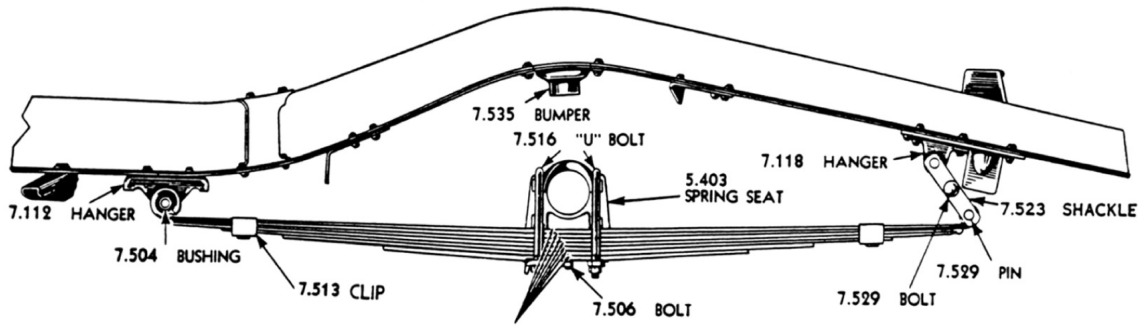
1949 Truck with Wood Accents

Returns require a return authorization number, please call.

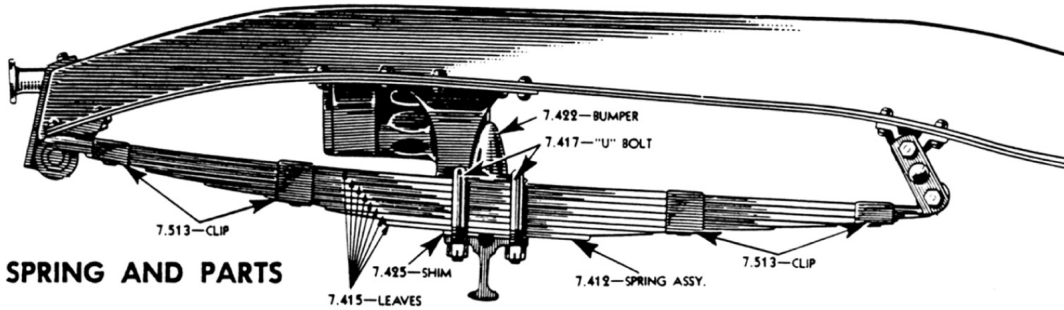
200T: Front Suspension Components, Shocks, King Pins & Shackles



Format = Part No., Year, Description, original Chevrolet Part Book Group No., Price and Unit Measure.

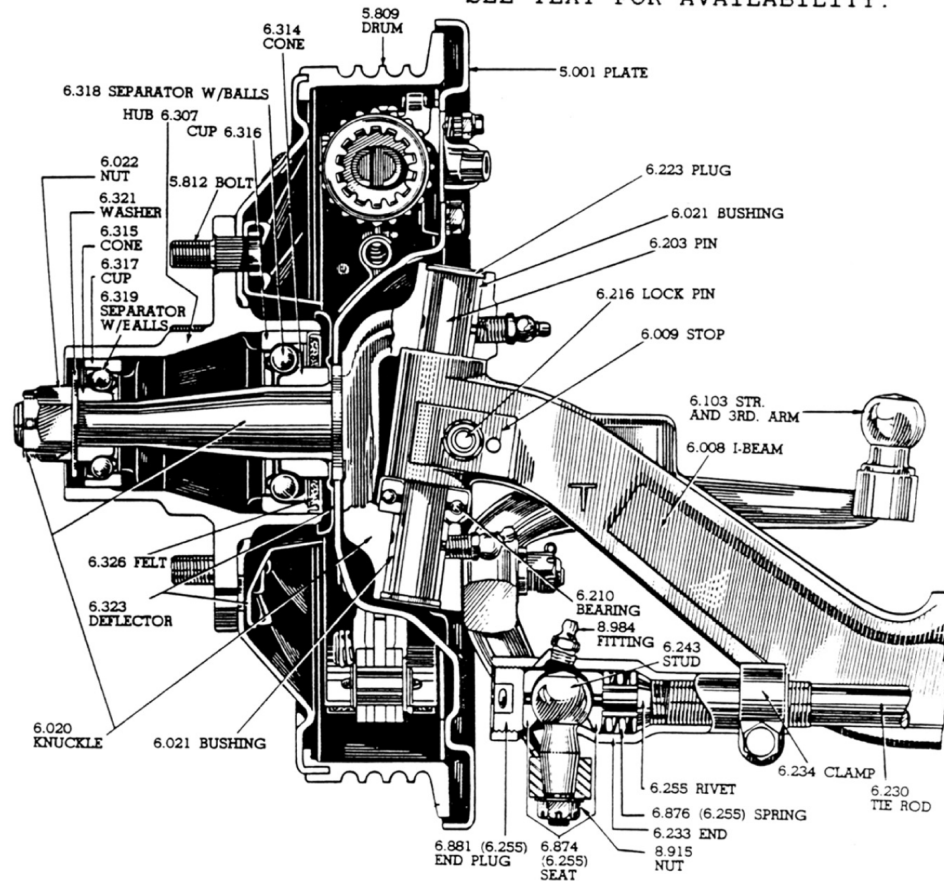


REAR SPRING AND PARTS



FRONT SPRING AND PARTS

ILLUSTRATIONS ARE COMPLETE ASSEMBLIES.
SEE TEXT FOR AVAILABILITY.



FRONT AXLE—CONVENTIONAL TRUCK (EXC. HVY. DUTY)

200T

Providing part #'s speeds up your order, improves accuracy, and helps us maintain low prices.

See Illustration Index for core charge information and a list of abbreviations. For Body Model information, see 5T. 125



200T: Front Suspension Components, Shocks, King Pins & Shackles

Format = Part No., Year, Description, original Chevrolet Part Book Group No., Price and Unit Measure.

Grease Fitting



191758 ALL
1/8in. national pipe,
straight. (08.984-4)
\$1.25 EA



110347 ALL
1/4in. x 28 taper thread,
90 degree. (08.984-3)
\$1.25 EA

Shocks



1072707 **34-50**
Right front, dual action (#1730-A) \$75 core.
(07.345-15)
\$183.75 EA

1072708 **34-50**
Left front, dual action (#1430-B) \$75 core
(07.345-15)
\$183.75 EA



5516237G **50-54**
Front, 1/2T & 3/4T (07.345-2)
\$57.25 SET

Shock Absorber Fluid



603489S ALL
(06.386-3)
\$6.75 QT

Tube Shock Mounts



3700440 **47-54**
Upper front or rear. Fits
1/2T (replacement for
50-54). (07.395-15)
\$35.25 EA

Tube Shock Mounts



3693687 **47-54**
Lower front, left
(07.395-0)
\$20.50 EA



3693688 **47-54**
Lower front, right
(07.395-0)
\$20.50 EA



3655328 **47-54**
Lower rear, left or right,
1/2T (replacement for
50-54). (07.395-15)
\$21.75 EA

Shock Conversion Kit



3700440B **47-49**
W/ gas shocks (4). Includes hardware &
brackets. 1/2T. (07.395-15)
\$298.00 SET

Shock Link



043032A **30-49**
9-5/16in. overall (07.355-3)
\$20.00 EA

Bushings



041133 **30-49**
Shock link, 1/2T, 3/4T.
(07.388-3)
\$8.00 PR



041133B **30-49**
Shock link single action-
w/ brass bushings, pins
& cotter keys, beam
axle superior.
(07.388-3)
\$11.00 PR

Bushings



043816 **33-53**
Shock link double action
shock 33-46 all, 47-49
1/2, 3/4, 1T & 50-55
double duty. (07.388-4)
\$6.00 SET



3501467 **39-46**
Sway bar (rubber) use
with #350146 (2 piece)
(07.240-3)
\$14.00 SET



350146 **39-46**
Sway bar shaft (steel
bushed rubber) use with
#3501467 (07.240-3)
\$24.75 PR



3708378 **50-57**
Shock, rubber (8), w/
washers & nuts.
(07.388-4)
\$14.25 SET



3708378 **50-54**
Sway bar rubber links
(8) w/ washers & nuts
(07.388-4)
\$14.25 SET

King Pins



602691 **29-39**
1/2T, 34-39 3/4 & 1T (06.203-15)
\$78.75 PR



601019 **31-52**
46-52 3/4, 1T & 31-50 1-
1/2T (06.203-15)
\$50.00 PR



602690 **40**
1/2T, 3/4T & 1T
(06.203-15)
\$69.00 PR

Returns require a return authorization number, please call.

200T: Front Suspension Components, Shocks, King Pins & Shackles



Format = Part No., Year, Description, original Chevrolet Part Book Group No., Price and Unit Measure.

King Pins



605121 41-54
1/2T (06.203-15)
\$49.00 PR



3691111 46-57
Double duty, 2T, 46-47
1-1/2T, 48-57 1-1/2T
heavy duty (06.203-15)
\$44.50 PR



3704112 53-54
3/4, 1, 1-1/2T (exc
Double-duty, School
Bus chassis, heavy
duty) (06.203-2)
\$65.00 PR

Shackles



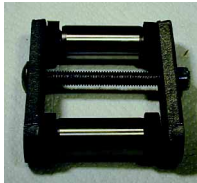
604478 34-46
Front 34-36 all, 37-40
(exc COE) 41-46 1/2T &
3/4T (07.523-3)
\$85.00 SET



609071 39-54
Front COE & 41-46 1, 1-
1/2T, 2T (07.436-3)
\$72.75 SET



3847459 47-54
Front (1/2T & 3/4T)
(07.436-3)
\$52.00 SET



3847460 47-56
Front 1T & larger exc
Double Duty & COE
(07.436-3)
\$62.00 SET

Shackle Rebuild Kit



373199 30-54
Does 2, pins, bushings
& seals, 1/2T & 3/4T (16
pcs). (07.427-4)
\$41.50 SET

Shackle Rebuild Kit



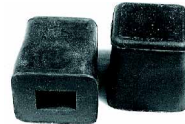
3653273..... 39-54
Does 2, pins, bushings,
seals, 39-40 COE, 41-
54 1, 1-1/2T, 2T, Double
Duty (16 piece)
(07.427-4)
\$34.00 SET

Seals

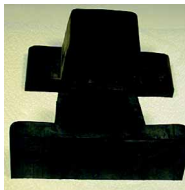


593705..... 34-54
Rubber for steel bushed
shackles (8 pcs).
(07.443-4)
\$9.25 SET

Bumper-Axle

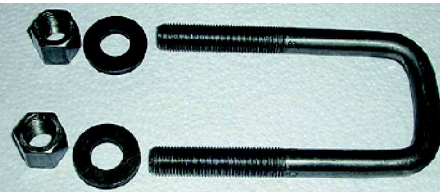


3653084..... 40-54
Axle (exc Double Duty &
53-54 3/4, 1, 1-1/2T & 2-
ton) (07.422-3)
\$16.00 SET



3700034..... 52-57
52-54 1T, 53-54 3/4T,
55-57 all. (07.535-3)
\$31.50 SET

U-bolt



601231 34-54
W/ nuts, front axle to spring, 34-49 1/2, 3/4,
1T & 50-54 1/2T (07.417-15)
\$11.25 EA

Bolt



1288224..... ALL
Leaf spring center (exc
utility vehicle) (2 pcs).
(07.506-4)
\$1.50 SET

Front Leaf Spring

Note: Spring Order requires purchase of fixed end pins & bushings (pressed in free).

599316 39-46
1/2T (7 leaves) (07.412-15)

\$460.00 PR

3656610 41-46
3/4T (8 leaves) (07.412-15)

\$470.00 PR

3702793 47-54
1/2T & 3/4T, exc Double Duty (8 leaves)
(07.412-15)

\$450.00 PR

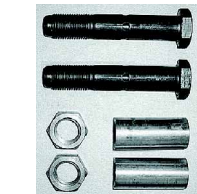
Oversize shipping charges apply to all Front Leaf Springs. Please call for rate.

Bolt & Bushing



593990B 37-54
Fixed end front springs,
1/2T & 3/4T (2 piece)
(07.428-3)

\$39.25 SET



3657393 39-54
Fixed end front spring,
41-54 1, 1-1/2T & 2T
(39-40 COE) (07.428-3)

\$40.50 PR

Liner



3699910T 37-54
For leaf springs.
(07.495-4)

\$23.75 SET

Sway Bar



3683028 47-54
Sway bar, front, complete, 1-1/8in.
diameter w/ links and bushings (07.241-15)
\$152.00 SET

200T

Providing part #'s speeds up your order, improves accuracy, and helps us maintain low prices.

See Illustration Index for core charge information and a list of abbreviations. For Body Model information, see 5T. 127



200T: Front Suspension Components, Shocks, King Pins & Shackles

Format = Part No., Year, Description, original Chevrolet Part Book Group No., Price and Unit Measure.

Odds & Ends

Please call for availability on all Odds & Ends parts; once part is sold, it may no longer be in stock.

593044 37-40

Bushing, King Pin, GB, HB, JB, KB, KC
(15-0)

\$10.00 EA

3186987U

Delco shock. 14-1/2in. compressed, 22-1/2in. extended. Verify fitment for your vehicle. (07.345-0)

\$20.00 EA

4984842U

Delco shock. 15in. compressed, 23-1/2in. extended. Verify fitment for your vehicle. (07.345-0)

\$20.00 EA

603537N 29-39

King pins NOS .010 over, fits 29-39 1/2 ton & 34-39 3/4 ton (06.203-0)

\$75.00 EA

602691N 37-39

King pin repair kit NOS fits all COMM
(06.203-0)

\$25.00 EA

1054146U 50

Shock front left used fits Double Duty
(07.345-0)

\$75.00 EA

301231N 50-55

U-bolts, fits front- 1st series. No nuts or washers. (-0)

\$20.00 PR

Returns require a return authorization number, please call.

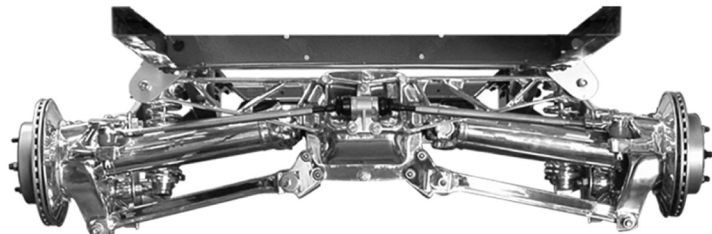
205T: Front & Rear Suspension Conversions



Format = Part No., Year, Description, original Chevrolet Part Book Group No., Price and Unit Measure.

Independent Front & Rear Suspension Kits

Now you can have the ride, superior handling, cornering and braking provided only by the advanced technology built into the Corvette suspension.



Rear kit shown assembled and polished



Front kit shown assembled and polished

Chevs of the 40's now offers quality kits to adapt the late model ('84-'87 and '88-'95) Corvette front and rear independent suspensions to your '47-'55 Chevy truck.

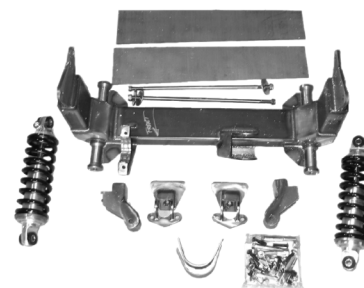


IRS kit shown with optional coil overs

These kits are designed to fit *your* frame. All brackets are laser cut from cold rolled steel and heli-arc welded for strength and unsurpassed good looks.

These kits utilize Corvette C-4 front and rear suspension components mounted to your frame using the stock Corvette geometry. The real bonus is this system uses the stock Corvette Power Rack and Pinion Steering Unit as designed by GM, eliminating any "bump steer" problems inherent with units from vehicles designed in the '70s with light weight vehicles and economy in mind.

You can have GM sports car handling on your GM manufactured truck. All the Corvette suspension components are manufactured from forged aluminum which allows you to decrease vehicle weight while also maintaining strength and a solid suspension.



IFS kit shown with optional coil overs

Not only will you be amazed at how well your truck rides but how fun it will be to drive with a Corvette front and rear suspension installed. And let's not forget 4-wheel disc brakes *designed* to mount to your suspension.

Available Aldan Eagle coil over shocks for front or rear allow you to adjust the ride to your liking with 6-position adjustable compression damping and spring rate adjustment also. Rugged construction and combination of oil and gas charging incorporated in each shock are only part of the reason we recommend them with our IFS and IRS kits. Kits come complete with instructions and all hardware.

You'll enjoy the handling and new life brought to your truck with these very affordable suspension kits for years to come.

Front Suspension

- SUSCORF1 84-87 C-4 IFS-front without coil over shocks (see below) \$795.00
- SUSCORF2 88-96 C-4 IFS-front without coil over shocks (see below) \$850.00

Rear Suspension

- SUSCORR1 84-87 C-4 IRS-rear without coil over shocks (see below) \$710.00
- SUSCORR2 88-96 C-4 IRS-rear without coil over shocks (see below) \$725.00

Aldan Coil-Over Shocks

- SHOCKF1 Front shock \$399.00 pr
- SHOCKF2 Front shock w/ chrome springs \$479.00 pr
- SHOCKF3 Front shock w/ polished housing \$454.00 pr
- SHOCKF4 Front shock w/ chrome springs & polished housing \$534.00 pr
- SHOCKR1 Rear shock \$399.00 pr
- SHOCKR2 Rear shock w/ chrome springs \$479.00 pr
- SHOCKR3 Rear shock w/ polished housing \$454.00 pr
- SHOCKR4 Rear shock w/ chrome springs & polished housing \$534.00 pr



205T

Providing part #'s speeds up your order, improves accuracy, and helps us maintain low prices.

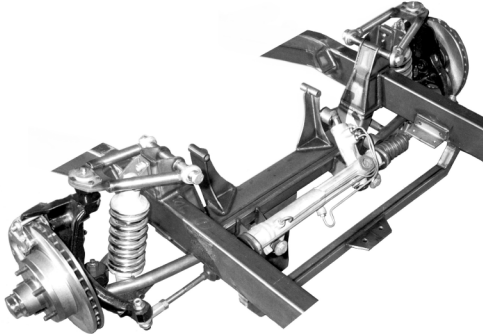
See Illustration Index for core charge information and a list of abbreviations. For Body Model information, see 5T. 129



205T: Front & Rear Suspension Conversions

Format = Part No., Year, Description, original Chevrolet Part Book Group No., Price and Unit Measure.

Keep your GM all GM with our custom front and rear subframes designed to fit your chassis using GM-based components



No longer do you have to go to the junk yard to buy a Camaro or whatever front chassis section to "clip" your car or truck frame. We have been making custom designed front IFS and rear IRS, standard, or stepped chassis subframes for a few years now, and it has become part of our standard product line. We can design a front or rear-steer subframe for any street rod, classic Chevy, large car or truck. Whether you want air bags, or coilovers, we will design an IFS subframe that will be the same width as your chassis rails, have the same wheel base, any track width, any step over the front IFS, engine mounts, rack-and-pinion steering, core support mount or whatever is necessary. Computer generated, mandril-bent, custom steps over the IFS is also an option.

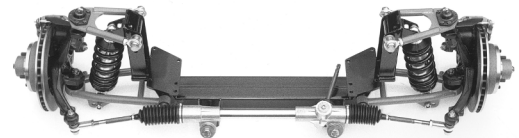
Our standard brake packages with these IFS "clips" are the '70-'81 Camaro 11-inch disc brake (5-on-4 3/4) or the '77-'88 Impala/Caprice 12-inch disc brake (5-on-5). We offer steering linkage kits, stock column adapters to splined U-joints, Flaming River or ididit columns to solve your steering hook-up problems.

The rear chassis subframes can be tubbed, stepped, air bagged or whatever you'd like. To complete your new rear clip, we jig-narrow and straighten Ford rearends and use Dutchman alloy axles any spline, any wheel bolt-pattern, big or small bearings, any flange (GM, Ford or Mopar). We also offer a universal rear 4-link kit with two styles of Panhard bars and a universal transmission crossmember/trans mount kit. Both come extra long so you can cut-to-fit for your chassis needs.

Send us the dimensions for a free estimate. Other options include custom bent 1-inch od front-and -rear sway bars, Wilwood or Baer high performance brakes. Complete rearends or housings are available from Halibrand, Alston's FAB9, new '58 Ford style housings, Championship style, a used housing from our pile or bring your own! We are a dealer for Air Ride Technologies, Baer Racing Brakes, Wilwood and many other popular street rod and classic Chevy manufacturers.

Bring your ride into the 21st century and have a great handling hot rod with a custom subframe! You'll have rack-and-pinion steering, disc brakes, narrower front track for more turning room under the fender, coilovers or air bags, and it will mate perfectly to the width of your existing frame rails. Most of all you'll have all the adjustability we build into all of our other IFS kits and direct replacement chassis!

Weld-in Front-Steer IFS for Cars & Pickups '33-54 Chevy Cars • '33-59 Chevy PU



This front-steer, independent front suspension (I.F.S.) is designed for those early cars and trucks that have plenty of space in front of the crossmember for the rack-and-pinion steering. The weld-in kits are available for '33-'54 Chevy cars and '33-'59 Chevy trucks in Stage I or Stage II.

The most complete kit, Stage II, features a 2 X 4 X .188-inch wall box-tube crossmember that holds the D.O.M. 1-inch diameter X .156-inch wall lower tubular A-arms and 7/8-inch diameter X .156-inch wall upper tubular control A-arms. Steering is provided by a Flaming River manual rack-and-pinion, while two '70-'81 GM Camaro spindles, ball joints, 11-inch rotors, and calipers give you stock over-the-counter GM parts available most everywhere! With a two-position lower mount and a three-position upper mount, the Hal Corp. aluminum, adjustable coilover-shocks will give the stance you like best!

Our popular Stage I kit (designed to use the Stage II components) features everything in the Stage II kit except the spindles, balljoints, rotors, calipers, and rack.

Your options (can be substituted at an additional cost) include a '83-'89 T-Bird power rack, chrome A-arms, 12-inch diameter rotors, bolt-pattern changes, front sub-frames, anti-sway bars, and different tread-widths are available.

Returns require a return authorization number, please call.



Format = Part No., Year, Description, original Chevrolet Part Book Group No., Price and Unit Measure.

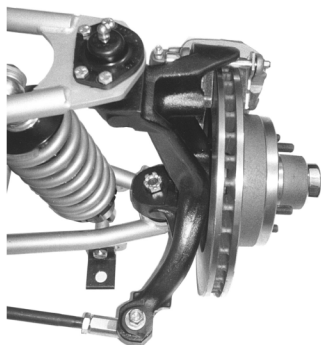
We offer stance adjustability like no one else!

All of our IFS kits with either air bags, ShockWave™ units or coilovers have an adjustable upper A-arm tower-mount that gives you about 3-inches of adjustment up-and-down. All of our lower A-arms have a two position lower mount for coilovers or ShockWave™ Air Ride systems. At the rear of our chassis, you'll find a three-position mount for either coilovers or shocks. Combine this with the adjustability of our Hal coilovers and you'll have 3-4-inches of stance adjustment up front and the same at the rear with any of our IFS kits, chassis clips, or direct replacement chassis!

The basis for all our IFS kits

You'll notice there is one thing in common about all our IFS kits, and that's the use of the stock GM '70-'81 Camaro front spindle. We've really chosen this spindle for the benefit of our customers. Let me point out why we like these front-steer spindles so much!

They offer either an 11 or 12-inch GM brake package with 2-15/16-inch diameter caliper pistons, vented rotors on the same balljoints using either the 11- or 12-inch spindle. These very popular balljoints were used by GM on their mid-sized cars from '73-'88, and on '77-'88 Caprice/Impala (12-inch disc brakes, most with 5-on-5 bolt pattern) and the '70-'81 Camaro with 11-inch brakes (5-on-4 3/4 pattern).



So what does this mean to you? The brake options using these spindles are better than anything else over the counter! We use very common, easy-to-find parts at the junk yard or over-the-counter at any parts house! With our product line, you can have either 11- or 12-inch (Delco caliper) disc brakes without having to change a thing! This caliper applies much more pressure on the rotor than later down-sized versions!

This also means to our customers on a budget that buying our economical Stage I kits lets you save about \$800 (over the complete Stage II)! Every kit is available in a Stage I form! The Stage I allows you to provide spindles, rotors, calipers, balljoints, and rack from a donor car or directly over the counter from any parts house in the USA or Canada! All of our IFS kits are alignable at any frontend shop or GM dealer!

205T

Providing part #'s speeds up your order, improves accuracy, and helps us maintain low prices.

See Illustration Index for core charge information and a list of abbreviations. For Body Model information, see 5T. 131



205T: Front & Rear Suspension Conversions

Format = Part No., Year, Description, original Chevrolet Part Book Group No., Price and Unit Measure.

JIM MEYER RACING PRODUCTS, INC.

Revised
1/07

2007 PRICE LIST

<u>I.F.S.</u>		<u>REAR SUSPENSION</u>	
WELD IN STD. F.S. IFS-10-1/2" ROTORS	2450.00	4-BAR KITS	325.00
WELD IN STD. F.S. IFS-11" ROTORS	2600.00	4-LINK KITS-WITH 4130 ROD ENDS	525.00
WELD IN STD. F.S. IFS-STAGE I	1800.00	PANHARD ROD ASSEMBLY	125.00
BOLT IN STD. IFS-ADD	200.00	G-4 PANHARD ROD	295.00
WELD IN STD. F.S. PICKUP IFS-11" ROTORS	2600.00	LOWER SHOCK MOUNTS-STD. OR G-4	95.00
WELD IN STD. F.S. PICKUP IFS-STAGE I	1800.00	C/O CROSSMEMBER-STD. OR G-4	95.00
WELD IN HD. F.S. IFS-12" ROTORS	2995.00	REAR SUSPENSION KIT-Std. Kit	935.00
WELD IN HD. F.S. IFS-STAGE I	2200.00	G-4 REAR SUSPENSION KIT	1095.00
WELD IN STD. R.S. IFS-10-1/2" ROTORS	2550.00	REAR SUB FRAME	995.00
WELD IN STD. R.S. IFS-11" ROTORS	2700.00	9" HOUSING - any width	1095.00
WELD IN STD. R.S. IFS-STAGE I	2100.00	(Suspension kit installed with new Dutchman axles & bearings-Suspension kit additional)	
WELD IN STD. NARROW IFS-10-1/2" ROTORS	2550.00	FABRICATED 9" HOUSING - additional	350.00
CHEVY II-NOVA IFS-11" ROTORS	2795.00	ENGINE & TRANSMISSION MOUNT KITS	279.00
CHEVY II-NOVA IFS-STAGE I	1895.00	TRANS/MOTOR MNT KIT/ENERGY SUSPN M/M	379.00
60-87 CHEVY P.U. IFS-12" ROTORS	3425.00	MOTOR MOUNTS-Frame Brackets	125.00
60-87 CHEVY P.U. IFS-STAGE I	2850.00	MANUAL MASTER CYLINDER	75.00
55-57 CHEVY BOLT IN IFS-11" ROTORS	2795.00	BRAKE BOOSTER & MASTER CYLINDER 7"	179.00
55-57 CHEVY BOLT IN ECONO IFS	1495.00	BRAKE PEDAL - 7" BOOSTER & M/C	350.00
53-62 CORVETTE IFS-10-1/2" ROTORS	2750.00	8" BOOSTER-Upgrade	100.00
53-62 CORVETTE IFS-11" ROTORS	2900.00	CLUTCH PEDAL - Additional	45.00
53-62 CORVETTE IFS-STAGE I	2295.00	53-62 CORVETTE MASTER CYLINDER KIT-manual	295.00
63-82 CORVETTE-"A" ARM & C/O KIT	1495.00	53-62 CORVETTE MASTER CYLINDER KIT-power	595.00
63-82 CORVETTE-SUSPENSION KIT	2195.00	ROD ENDS-TEFLON LINED:	
64-72 CHEVELLE-SUSPENSION KIT	2195.00	1018	4130
67-81 CAMARO PRO TOURING SUBFRAME	6495.00	3/8"	10.00 15.00
		1/2"	14.00 21.00
		5/8"	18.00 26.00
		3/4"	20.00 32.00
		URETHANE BUSHINGS	6.00
		3/4" ADJUSTER WITH BUSHINGS	25.00
		TRI-5 REAR LADDER BAR KIT	850.00
		<u>I.F.S. PARTS</u>	
		H.D. 'A' ARMS - Lower - pr.	450.00
		Top - pr.	250.00
		BALL JOINTS-Most	25.00
		BALL JOINT BOOTS-ea.	5.00
		U-JOINTS - FLAMING RIVER	75.00
		DOUBLE D SHAFT - per inch	1.50
		FRONT SUB FRAME or REAR SUBFRAME	995.00
		53-62 CORVETTE STEERING COLUMN MOUNT	95.00
		CORVETTE COLUMN BUSHING	25.00
		TIE ROD ENDS & ADAPTERS	95.00
		PIVOT SHAFT ASSEMBLIES-pr.	95.00
		QA1 C/O SHOCKS WITH SPRINGS	400.00
		QA1 ADJUSTABLE SHOCKS WITH SPRINGS	495.00
		QA1 DOUBLE ADJUSTABLE SHOCKS WITH SPRINGS	795.00
		COIL OVER SPRINGS - pr.	95.00
		BOLT ON TOP SHOCK MOUNT - pr.	75.00
		CROSSMEMBER ASSEMBLY - Most models	650.00
		CORE SUPPORT CROSSMEMBERS	125.00
		SPINDLES - Front Steer-67-72 GM 11"	250.00
		or Rear Steer- new-with arms pr.	
		DROPPED SPINDLES	295.00
		BIG SPRING COIL OVER CONVERSION	180.00
		BIG SPRING COIL OVER CONVERSION UPGRADE	125.00
		STAINLESS BRAKE HOSE KIT	85.00
<u>I.F.S. OPTIONS-ADDITIONAL</u>			
<u>AIR SUSPENSIONS</u>			
Air Ride Tech. Shocks - pr.	900.00		
Firestone Air Bags - ea.	125.00		
Air Comp. Kit - 4 Wheel-ARC4100EZ	1695.00		
Air Comp. Kit - 2 Wheel - ARC4000	699.00		
Add Air to I.F.S.	600.00		
Add Air to R. Suspension Kit	600.00		
ANTI-SWAY BAR KITS-Std. Front	175.00		
ANTI-SWAY BAR KIT-Heavy Duty Nascar Bar	275.00		
12" ROTORS & CALIPERS-Upgrade	200.00		
CHANGE ROTOR BOLT PATTERN	125.00		
STEERING HOOK UP KIT - 2 pc.	195.00		
3-pc.	295.00		
CORVETTE 3 PC. with Brackets	360.00		
BAER BRAKES-FRONT-12" or 13"	1695.00		
REAR-12"	1145.00		
DRILL-SLOT-ZINC WASH-ROTORS-PR.	150.00		
<u>FRONT WILWOOD BRAKE KIT 12"</u>			
DRILLED ROTORS	995.00		
POLISHED & DRILLED	1150.00		
FRONT 13" ADD \$600.00 TO ABOVE			
<u>REAR WILWOOD BRAKE 12" WITH E. BRAKE</u>			
DRILLED ROTORS	995.00		
POLISHED & DRILLED	1150.00		
RACK & PINION FITTINGS - PR.	35.00		
DRILLED-SLOTTED ROTORS 11" PR.	195.00		
CORVETTE P.S.	895.00		
Pump, Pulleys - Bracket, Hoses			
Side Motor Mounts			

Returns require a return authorization number, please call.

210T: Rear Suspension Components & Shocks



Format = Part No., Year, Description, original Chevrolet Part Book Group No., Price and Unit Measure.

Street Rod Parts

Lowering Blocks



373201B.....37-54
2in. , w/ u-bolts. (07.427-15)
\$60.00 SET

.....37-54
3in. , w/ u-bolts. (07.427-0)
\$65.00 SET

Conversion Kit



3700440B.....47-49
W/ gas shocks (4), hardware and brackets,
1/2T. (07.395-15)
\$298.00 SET

Restoration Parts

Single Action Shock



1054421.....34-49
Left rear, 1/2Tt, #1430MA (\$50 core).
(07.345-15)

\$171.00 EA

535256.....34-49
Right rear, 1/2T, #1430LP (core \$50).
(07.345-15)

\$171.00 EA

Dual Action Shock



1054425.....34-47
Left rear, #1731-U (\$50 core). (07.345-15)
\$162.00 EA

1054424.....34-47
Right rear, #1731-T (\$50 core). (07.345-15)
\$162.00 EA

1054424.....48-49
Left rear, #1731-T (\$50 core). (07.345-15)
\$162.00 EA

1054425.....48-49
Right rear, #1731-U (\$50 core).
(07.345-15)
\$162.00 EA

Shocks



5516239G47-54
Rear, 1/2T (original 50-54 will fit 47-49 w/
conversion). (07.345-4)

\$50.75 PR

5394579G47-54
Rear, 3/4T (original 50-54 will fit 47-49 w/
conversion). (07.345-2)

\$65.00 SET

Tube Shock Mounts



3700440..... 47-54
Upper front or rear. Fits
1/2T (replacement for
50-54). (07.395-15)

\$35.25 EA



3655328..... 47-54
Lower rear, left or right,
1/2T (replacement for
50-54). (07.395-15)

\$21.75 EA

Bushing



041133..... 30-49
For shock link, 1/2T,
3/4T. (07.388-3)
\$8.00 PR

Bushing



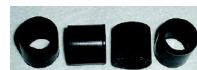
041133B 30-49
Shock link single action-
w/ brass bushings, pins
& cotter keys, beam
axle superior.
(07.388-3)

\$11.00 PR



041153..... 33-53
In shock arm, rubber,
double action.
(07.377-15)

\$7.25 EA



043816..... 33-53
Shock link double action
shock 33-46 all, 47-49
1/2, 3/4, 1T & 50-55
double duty. (07.388-4)

\$6.00 SET



3708378..... 50-57
Shock, rubber (8), w/
washers & nuts.
(07.388-4)

\$14.25 SET

Shackles-Rear



350441 34-54
1/2T & 3/4T (2 pcs).
(07.523-2)

\$65.00 SET

Shackle Rebuild Kit



373199..... 30-54
Does 2, pins, bushings
& seals, 1/2T & 3/4T (16
pcs). (07.427-4)

\$41.50 SET



3725531B 33-55
3/4T, 1T & Utility (exc
Panel). (07.573-15)

\$82.00 SET

Grease Fitting



191758..... ALL
1/8in. national pipe,
straight. (08.984-4)
\$1.25 EA

210T

Providing part #'s speeds up your order, improves accuracy, and helps us maintain low prices.

See Illustration Index for core charge information and a list of abbreviations. For Body Model information, see 5T. 133



210T: Rear Suspension Components & Shocks

Format = Part No., Year, Description, original Chevrolet Part Book Group No., Price and Unit Measure.

Grease Fitting



110347 **ALL**
1/4in. x 28 taper thread,
90 degree. (08.984-3)
\$1.25 EA

Seals-Shackle



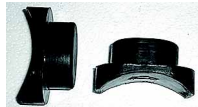
593705 **34-54**
Rubber for steel bushed
shackles (8 pcs).
(07.443-4)
\$9.25 SET

Bushing

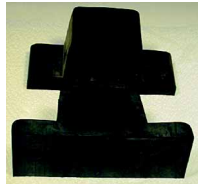


3652182A **48-54**
Bolt w/ nut, rear end to
spring, 1/2T. (05.403-2)
\$27.25 PR

Bumper-Rear Axle



365627 **34-46**
1/2T (07.535-15)
\$29.25 PR



3700034 **52-57**
52-54 1T, 53-54 3/4T,
55-57 all. (07.535-3)
\$31.50 SET

U-bolt



602509 **31-46**
Rear axle to spring, 1/2T. (07.417-15)
\$11.25 EA

601231 **47-54**
W/ nuts, rear axle to spring pivot, 1/2T.
(07.417-15)
\$11.25 EA

Bolt



1288224 **ALL**
Leaf spring center (exc
utility vehicle) (2 pcs).
(07.506-4)
\$1.50 SET

Teflon Liner



3699910T **37-54**
For leaf springs.
(07.495-4)
\$23.75 SET

Rear Leaf Spring

Note: Spring order requires purchase of
fixed end pins & bushings (pressed in
free).

SPECIFY65T **37-54**
Original springs will allow severe axle wrap
w/ the torque tube removed and these are
needed for an open drive shaft. Also helps
to center axle in wheel wells. Can be made
with arch to lower vehicle. (07.503-15)
\$450.00 EA

3659368 **36-46**
1/2T (8 leaves). (07.503-15)
\$625.00 PR

3683317 **47-54**
1/2T (8 leaves). (07.503-15)
\$635.00 PR

3656559 **41-54**
3/4T (7 leaves). (07.503-15)
\$615.00 PR

Oversize shipping charges apply to all
Rear Leaf Springs. Please call for rate.

Bolt & Bushing



593990B **34-54**
Front of rear spring,
1/2T. (07.428-3)
\$39.25 PR

Odds & Ends

Please call for availability on all Odds &
Ends parts; once part is sold, it may no
longer be in stock.

042852 **39-54**
Shock absorber link pin, fits 33-50 COMM
CT or 33-55 1.5 ton rear (09.650-0)
\$2.00 EA

3656558 **46-47**
U-bolt fits 1-1/2T, School bus chassis &
panel (07.516-0)
\$20.00 EA

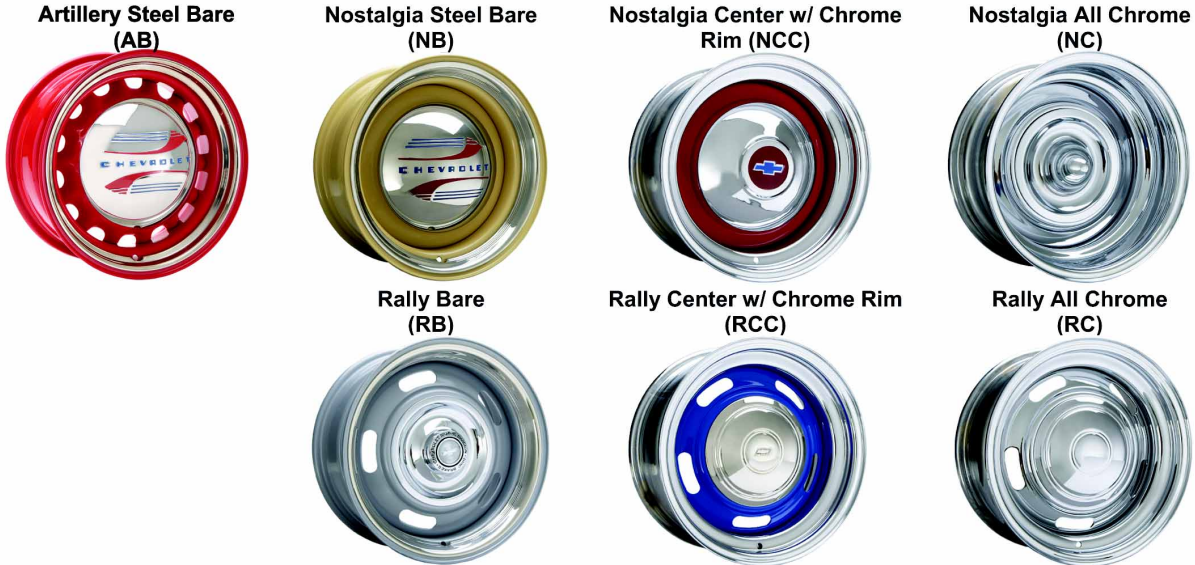
Returns require a return authorization number, please call.



Format = Part No., Year, Description, original Chevrolet Part Book Group No., Price and Unit Measure.

Custom Wheels

Group #5.803

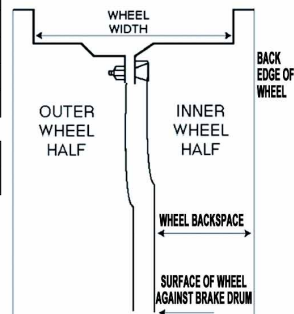


Wheels require modified hubcaps, which are sold separately—refer to following pages

	AB	NB	NCC	NC	RB	RCC	RC
	Artillery Bare	Nostalgia Steel Bare Center (Smoothie)	Nostalgia Steel Bare Center w/ Chrome Rim (Smoothie)	Nostalgia Steel All Chrome (Smoothie)	Rally Bare	Rally Bare Center w/ Chrome Rim	Rally All Chrome
14 x 5		\$50.00	\$66.00	\$74.00	\$60.00	\$76.00	\$84.00
14 x 6		\$50.00	\$66.00	\$74.00	\$60.00	\$76.00	\$84.00
14 x 7		\$58.75	\$79.00	\$90.25	\$68.75	\$89.00	\$100.25
15 x 5	\$115.00	\$54.00	\$75.00	\$82.00	\$64.00	\$85.00	\$92.00
15 x 6	\$118.00	\$55.00	\$75.00	\$82.00	\$65.00	\$85.00	\$92.00
15 x 7	\$121.00	\$59.00	\$80.00	\$85.00	\$69.00	\$90.00	\$95.00
15 x 8	\$124.00	\$65.00	\$87.00	\$92.00	\$75.00	\$97.00	\$102.00
15 x 10	\$152.00	\$74.00	\$108.00	\$112.00	\$84.00	\$118.00	\$122.00
15 x 12	\$217.00	\$135.00	\$165.00	\$186.00	\$145.00	\$175.00	\$196.00
15 x 14	\$229.00	\$145.00	\$175.00	\$195.00	\$155.00	\$185.00	\$205.00
16 x 6		\$88.00	\$104.00	\$115.00	\$98.00	\$114.00	\$125.00
16 x 7		\$101.00	\$115.00	\$117.00	\$111.00	\$125.00	\$127.00
16 x 8		\$101.00	\$126.00	\$122.00	\$111.00	\$136.00	\$132.00
16 x 10		\$122.00	\$142.00	\$164.00	\$132.00	\$152.00	\$174.00
16 x 12		\$152.00	\$172.00	\$182.00	\$162.00	\$182.00	\$192.00

Backspacing	14 x 5	14 x 6	14 x 7	15 x 5	15 x 6	15 x 7	15 x 8	15 x 10	15 x 12	15 x 14
Standard Backspace	3	3 1/4	3 1/2	2 3/4	3 1/2	4	4 1/4	4 1/2	4 1/4	4 1/4
Minimum (on standard)	3	3 1/4	3 3/4	2 3/4	3 1/2	4	4 1/4	4 1/2	4 1/4	4 1/4
Maximum (on standard)	3 5/8	4 1/2	5 1/4	3 1/4	4 1/4	5	6	7 1/2	9 3/4	11 3/4
Reverse (minimum)	1 3/4	1 3/4	1 3/4	2	2	2	2	2 1/2	2 1/2	2 1/2
Reverse (maximum)	2 5/8	3	3 1/2	2 5/8	2 3/4	3 1/8	4 1/4	5 3/4	7 1/2	9 1/2
Backspacing Min/ Max - Artillery Wheels										
Minimum (on standard)				2 1/2	3 1/2	3 3/4	4	4 1/2	4 1/2	4 1/2
Maximum (on standard)				3	4	5	5 3/4	7	8 1/2	9 1/2

Measure your installation carefully—deep back spacing on front wheels can sometimes cause interference between rim and disc brake caliper



Note: To order wheels choose style code (top row) & add size (left column)
Example: "NCC14x7"

220T

Providing part #'s speeds up your order, improves accuracy, and helps us maintain low prices.

See Illustration Index for core charge information and a list of abbreviations. For Body Model information, see 5T. 135



220T: Hub Caps, Beauty Rims, Wheels, Tires & Wheel Bearings

Format = Part No., Year, Description, original Chevrolet Part Book Group No., Price and Unit Measure.

Street Rod Parts

Billet Specialties Wheels

Need to add that final touch of class to your ride? We now offer the complete line of wheels from Billet Specialties. Please call for availability and sizing.

Hub Caps-Modified

5% discounts for sets of 4



594453M **37-38**
Stainless. Modified for nostalgia wheel (05.858-3)
\$58.75 EA



594453MR **37-38**
Modified for rally wheel (05.858-4)
\$75.50 EA

594453MRS **37-38**
Stainless. Modified for rally wheel (05.858-15)
\$58.75 EA

599748MRS **39**
Stainless. Modified to fit rally wheel (05.858-2)
\$58.75 EA

599748MS **39**
Stainless. Modified to fit nostalgia wheel (05.858-15)
\$58.75 EA

Hub Caps-Modified

5% discounts for sets of 4



599748MR **39**
Modified to fit rally wheel (05.858-4)
\$75.50 EA



654307M **40**
Modified to fit nostalgia wheel (05.858-4)
\$75.50 EA

654307MR **40**
Modified to fit rally wheel. (05.858-4)
\$75.50 EA



3658374M **41-48**
1941-48 Passenger (41-46 Commercial exc 46 1T). Modified to fit Nostalgia wheel. (05.858-2)
\$75.50 EA

3658374MR **41-46**
1941-48 Passenger (41-46 Commercial exc 46 1T) Modified to fit rally wheel. (05.858-4)
\$75.50 EA

3705092A **47-53**
1/2T, modified to fit nostalgia wheel (05.858-15)
\$63.00 EA

3705092AR **47-53**
1/2T, modified to fit rally wheel (05.858-4)
\$63.00 EA

Hub Caps-Modified

5% discounts for sets of 4



3705092M **37-48**
(Set only) Baby moon, 37-46 1/2T & 37-41 3/4T (05.858-2)
\$160.00 SET

3908671 **ALL**
Police, plain. Fits nostalgia wheel (05.858-3)
\$20.00 EA

3908671B **ALL**
Police, plain. Fits nostalgia wheel (05.858-3)
\$75.00 SET



3908672 **ALL**
Police, plain. Fits rally wheel (05.858-4)
\$37.50 EA

3908673B **ALL**
(Set only) Police w/ bowtie. Fits rally wheel (05.858-15)
\$125.00 SET

Hub Caps-Custom



HCAPCROSS14
14 inch Crossbar style. (05.858-15)
\$175.00 SET

Returns require a return authorization number, please call.

220T: Hub Caps, Beauty Rims, Wheels, Tires & Wheel Bearings



Format = Part No., Year, Description, original Chevrolet Part Book Group No., Price and Unit Measure.

Hub Caps-Custom

5% discounts for sets of 4



HCAPCROSS15
15 inch Crossbar style.
(05.858-15)
\$175.00 SET

HCAPLANCER14 37-54
14 inch 57 Lancer style.(05.858-15)
\$175.00 SET



HCAPLANCERB15 ...
37-54
15 inch 57 Lancer
style.(05.858-15)
\$175.00 SET

HCAPLANCER..... 37-54
15 inch 59 Lancer style.(05.858-15)
\$352.00 SET



3705092N 37-54
14" Nude Figure.
Chrome (05.858-15)
\$300.00 SET

37050920 37-54
15" Nude Figure. Chrome (05.858-15)
\$350.00 SET

Valve Stem Cap



CROWNCAPR.....**ALL**
Crown cap. Red plastic
(5 pcs) (05.804-15)
\$5.00 SET

Nude Lady



3705092H**ALL**
3 dimensional nude
figure handle or hubcap
ornament. Chrome, 12-
1/4in. length. (05.858-3)
\$38.00 EA

Restoration Parts

Hub Caps-Stock

5% discounts for sets of 4



2019471 37-46
GMC 1/2T & 37-41 GMC 3/4T. (05.858-15)
\$32.75 EA



594453S 37-38
Stainless (05.858-15)
\$39.50 EA



599748S 39
Stainless (05.858-15)
\$39.50 EA



654307S 40
Hub Caps (stainless steel) (05.858-15)
\$39.50 EA

Hub Caps-Stock

5% discounts for sets of 4



654307B 40
(05.858-0)
\$200.00 SET

3658374S 41-48
Stainless 1941-48 Passenger (41-46
Commercial exc 46 1T) (05.858-15)
\$30.75 EA



3705092 47-53
1/2T. Chrome. (05.858-15)
\$40.00 EA



3705092S 47-53
1/2T. Stainless steel. (05.858-2)
\$50.00 EA

3705092B 47-53
1/2T (05.858-15)
\$155.00 SET



3680919 47-53
Chrome with red (3/4, 1T) (05.858-15)
\$47.50 EA

220T

Providing part #'s speeds up your order, improves accuracy, and helps us maintain low prices.

See Illustration Index for core charge information and a list of abbreviations. For Body Model information, see 5T. 137



220T: Hub Caps, Beauty Rims, Wheels, Tires & Wheel Bearings

Format = Part No., Year, Description, original Chevrolet Part Book Group No., Price and Unit Measure.

Hub Caps-Stock

5% discounts for sets of 4



3705092P 47-53
GMC chrome with white lettering. 1/2T only
(05.858-15)
\$28.50 EA

3705092G 47-53
GMC chrome with red lettering. 1/2T only
(05.858-15)
\$28.50 EA



3708057 54
Superior 1/2T (05.858-2)
\$52.50 EA

3708057C 54
1/2T (05.858-15)
\$28.50 EA



3708058 55-59
GMC 1/2T (superior) (05.858-0)
\$200.00 SET



3704844 39-53
Retaining clip. Fits 39-53 Pass & 1/2T truck.
(05.864-15)
\$1.25 EA

Decal Hub Cap

3705092R 47-53
Red (set of 4) (05.858-4)

\$8.00 SET

3705092K 47-53
Black (set of 4) (05.858-0)

\$2.00 EA

3705092GR 47-55
GMC decal. Red (set of 4) (05.858-0)

\$2.00 EA

3705092GK 47-55
GMC decal. Black (set of 4) (05.858-4)

\$7.50 EA

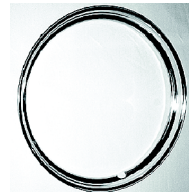
3705092GW 47-55
GMC decal. White (set of 4) (05.858-0)

\$2.00 SET

Beauty Ring



986259 ALL
15in. (outer wheel)-
original (05.858-15)
\$26.00 EA



1279680 ALL
16in. (outer wheel)-
original (05.858-15)
\$26.00 EA

Tires

Oversize shipping charges apply.
Please call for rate.

Tire - White Wall, Radial

Note: All tires must be inflated to
manufacturers recommended PSI.



368981R ALL
(670x15) Coker classic. 2-3/8in. white wall
(05.804-0)

\$164.00 EA

368982R ALL
(670x16) 3in. white wall (05.804-0)

\$184.00 EA

3693215R ALL
(650x16) 3-1/2in. white wall (05.804-0)

\$179.00 EA



3693215RC ALL
(650x16) Coker Classic
3-1/4in. white wall.

(05.804-0)

\$196.00 EA

Tire - Black Wall, Radial



599887R ALL
(600x16) BF Goodrich.

Made from original
molds. (05.804-0)

\$169.00 EA

Returns require a return authorization number, please call.

220T: Hub Caps, Beauty Rims, Wheels, Tires & Wheel Bearings



Format = Part No., Year, Description, original Chevrolet Part Book Group No., Price and Unit Measure.

Tire - White Wall, Bias Ply



- 599886** ALL
(600x16) BF Goodrich 3-1/2in. white wall.
Made from original molds. (05.804-0)
\$128.00 EA
- 3693215** ALL
(650x16) BF Goodrich 3-3/4in. white wall
(05.804-0)
\$132.00 EA
- 3693215RB** ALL
(650x16) Firestone 3-1/4in. white wall.
(05.804-0)
\$139.00 EA
- 368981** ALL
(670x15) BF Goodrich 3-5/8in. white wall
tubeless (05.804-0)
\$127.00 EA

Tire - Black Wall, Bias Ply



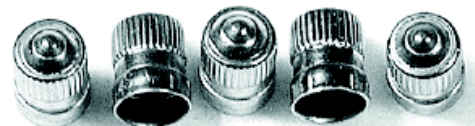
- 599887** ALL
(600x16) BF Goodrich. 4 ply. Made from
original moulds. (05.804-0)
\$106.00 EA
- 3693215B** ALL
(650x16) BF Goodrich. (05.804-0)
\$114.00 EA
- 368981B** ALL
(670x15) BF Goodrich. Tubeless.
(05.804-0)
\$109.00 EA

Tube



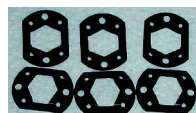
- 599885** ALL
600-650 x 16 (05.804-0)
\$13.00 EA

Valve Stem Cap



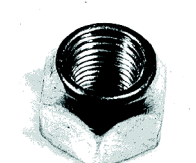
- 599884** ALL
Original metal style (5 pcs) (05.804-4)
\$6.50 SET

Tinnerman Nuts



- 365897** ALL
Retains rear brake drum
(6 pcs). (05.810-4)
\$3.50 SET

Lug Nut



- 358501** 29-57
Pass Car, 1/2T & 29-42
3/4 & 1T (05.813-4)
\$1.00 EA

Stud For Lug Nut



- 370465** 36-50
Front 1/2T & 36-42 3/4,
1T (05.812-2)
\$3.00 EA



- 476515** 51-57
Front 1/2T (05.812-4)
\$3.00 EA



- 375696** 36-57
Rear 1/2T & 36-42 3/4,
1T (05.812-2)
\$3.00 EA

Spindle Nut & Washer

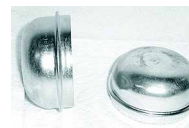


- 379656** 35-57
1-1/2T & 2T, 46-57 3/4T
(06.022-15)
\$6.00 SET



- 378137** 40-54
1/2T & 40-42 3/4, 1T
(06.022-3)
\$6.25 SET

Dust Cover



- 370262** 36-54
Front wheel bearing
dust cover. Fits 1/2T &
36-42 3/4 & 1T
(05.858-4)
\$10.00 PR

Front Wheel Bearing Seal



- 352488** 29-40
Cars & 1/2t trucks.
(06.326-4)
\$20.75 EA



- 379654** 35-57
1-1/2T, 46-57 3/4 & 1T
exc 42 bus, 51-52 1-
1/2T & heavy duty
(06.326-15)
\$29.00 EA



- 3656536** 41-57
1/2T, 41-42 3/4 & 1T
(06.326-4)
\$13.50 EA

Front Wheel Bearing-Inner



- 909002** 29-40
Inner. Front wheel. Fits Pass, 1/2T & 3/4T
(06.311-15)
\$85.00 EA
- 909026** 35-52
35-42 utility, 46-50 3/4, 1, 1-1/2T; 51-52 3/4
& 1T (06.311-15)
\$64.50 EA
- 909052** 41-57
Inner. Fits 41-42, 1/2T, 3/4, 1T (06.311-15)
\$61.00 EA
- 173241** 46-49
Utility, 2T, school bus chassis (06.317-15)
\$42.00 EA
- 909046** 53-57
3/4, 1, 1-1/2T (06.311-3)
\$68.25 EA

220T

Providing part #'s speeds up your order, improves accuracy, and helps us maintain low prices.

See Illustration Index for core charge information and a list of abbreviations. For Body Model information, see 5T. 139



220T: Hub Caps, Beauty Rims, Wheels, Tires & Wheel Bearings

Format = Part No., Year, Description, original Chevrolet Part Book Group No., Price and Unit Measure.

Front Wheel Bearing-Inner



909002R **29-40**
ROLLER replacement. Inner, front. PASS & 1/2T & 3/4T. (06.311-15)

\$96.00 EA

909026R **35-52**
Roller replacement 35-42 utility, 46-50 3/4, 1, 1-1/2T; 51-52 3/4 & 1T (06.311-15)

\$132.00 EA

909052R **41-57**
Inner. Roller replacement. Fits 1/2T, 41-42 3/4, 1T (06.311-15)

\$58.00 EA

909046R **53-57**
Roller replacement (3/4, 1, 1-1/2T) (06.311-15)

\$70.50 EA

Front Wheel Bearing-Outer



909001 **29-57**
Outer. Fits Pass and 1/2T & 29-42 3/4T (06.313-15)

\$35.00 EA

909025 **35-52**
35-42 1-1/2T, 2T; 46-50 3/4, 1, 1-1/2T; 51-52 3/4 & 1T (06.313-15)

\$36.00 EA

173238 **46-49**
2T & bus with 15/16in. diameter hole (49 early) (06.313-15)

\$48.00 EA

188932 **46-57**
3/4T, 1T rear (05.855-15)

\$20.40 EA

909045 **53-57**
3/4, 1, 1-1/2T (06.313-15)

\$43.00 EA

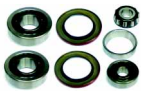
Front Wheel Bearing-Outer



909001R **29-57**
ROLLER replacement. Outer. Fits Pass & 1/2T & 29-42 3/4T (06.313-15)

\$46.00 EA

Roller Bearing Conversion



BEARINGKIT .. 41-57

Convert your ball bearings to roller. For both sides of front end. (06.311-15)

\$170.00 SET

Front Wheel Bearing-Outer

909025R **35-52**
Roller replacement (35-42 1-1/2T, 2T; 46-50 3/4, 1, 1-1/2T; 51-52 3/4 & 1T) (06.313-15)

\$76.75 EA

909045R **53-57**
Roller replacement (3/4, 1, 1-1/2T) (06.313-15)

\$84.25 EA

Odds & Ends

Please call for availability on all Odds & Ends parts; once part is sold, it may no longer be in stock.

986108N **47-48**
Accy. Tire Tracks (-4)

\$100.00 SET

986358U **49-50**
Accy. Wheel Cover (Used) (16-0)

\$45.00 EA

12380 **48**
Accy. Wheel Covers, 16in. (Used) (16-0)

\$65.00 EA

909602U **46-57**
Inner bearing cup, NOS fits 1/2 ton (06.316-0)

\$30.00 EA

Odds & Ends

909066 **60-61**
Front wheel bearing-inner, fits 1/2 ton (06.311-0)

\$25.00 EA

3705092AD **47-53**
Hub Cap-1/2T-modified Nost (Imperfect) (5.858-0)

\$30.00 EA

3658374U **41-48**
Hub Cap (Used) (16-0)

\$25.00 EA

654307MD **40**
Hub Cap-modified for Nostalgia Wheel (Imperfect) (5.858-0)

\$42.50 EA

3653926 **40-47**
Lock, Axle Shaft Bolt (Utility) (13*000-0)

\$2.00 EA

379655 **42-50**
Oil Deflector, Front Hum 1-1/2T (15~000-0)

\$5.00 EA

3689081N **40-47**
Rear Wheel Hub Conversion Kit (Utility) (13~000-0)

\$25.00 EA

909702 **29-50**
Wheel bearing separator assembly w/ balls inner fits all pass & 1/2 ton (06.318-0)

\$30.00 EA

985705 **41-42**
Wheel discs w/o ribs. Needs rechromed (16-0)

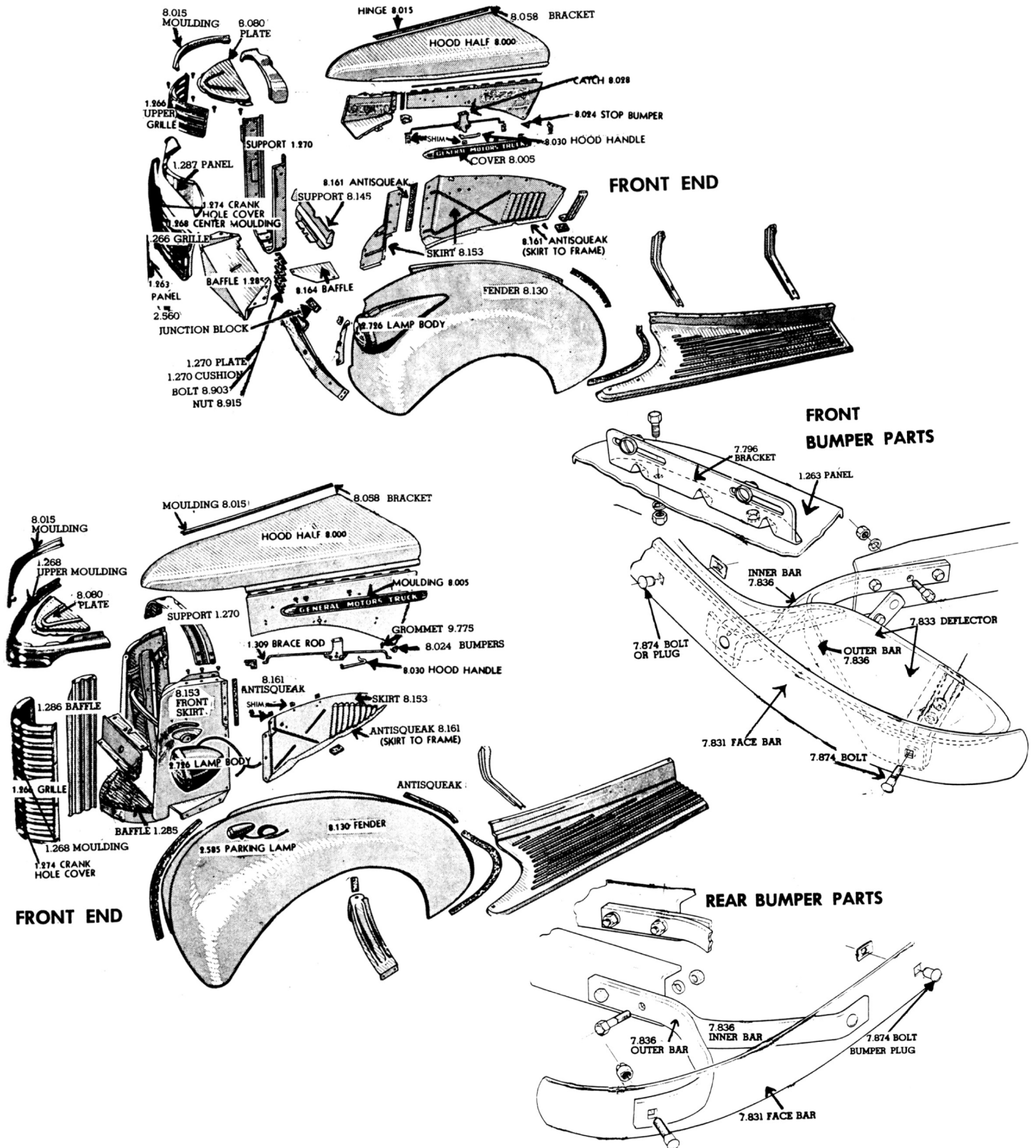
\$150.00 EA

Returns require a return authorization number, please call.

230T: Bumper



Format = Part No., Year, Description, original Chevrolet Part Book Group No., Price and Unit Measure.



230T

Providing part #'s speeds up your order, improves accuracy, and helps us maintain low prices.

See Illustration Index for core charge information and a list of abbreviations. For Body Model information, see 5T. 141



230T: Bumper

Format = Part No., Year, Description, original Chevrolet Part Book Group No., Price and Unit Measure.

Street Rod Parts

NEW! Contoured Briz Bumper



BRIZ5RIB-C
5-rib polished alloy bumper. Does not include brackets or bolts. Fits 47-54 Chevy trucks. 4-1/2" face. (07.831-15)
\$350.00 EA

Bumpers - Briz



BRIZ3RIB
3 rib, fully polished (on both sides) alloy bumper. 2-7/8" face. (07.831-15)
\$195.00 EA



BRIZ5RIB **35-48**
Original 5 rib, fully polished (on both sides) alloy bumper. Fits 41-54 Chevy trucks. 4-1/2" face. Mount Front or Rear. (07.831-15)
\$195.00 EA

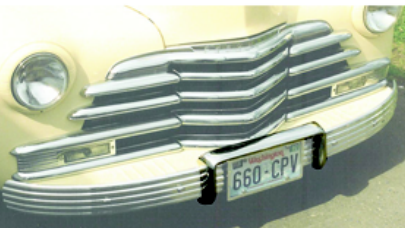
Bumpers - Briz



BRIZ5RIB-SHOEBOX
Original 5 rib polished alloy bumper. Fits 41-54 Chevy trucks. 4-1/2" face. (07.831-0)
\$205.00 EA

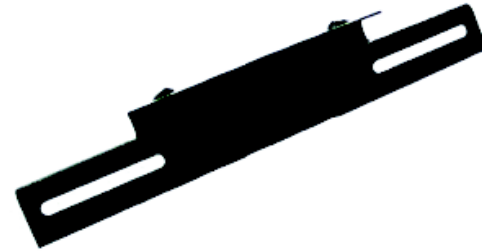


BRIZBOLT **ALL**
Polished, Stainless bumper bolt. Radiused head to fit over ribs. (-15)
\$6.00 EA



BRIZBGUARD
Polished (-15)
\$130.00 EA

Bumpers - Briz



BRIZBRKT
License plate mounting bracket for BRIZ license guard. (-0)
\$18.00 EA

Brackets for Briz Bumpers. Please call or visit our web site for your application.

Bumpers-Polished Stainless

Oversized shipping charges apply to. Please call for rate.



594648S **37**
Fits Master. (07.831-0)
\$345.00 EA



3847305S **38-39**
No holes. Studs for brackets welded to back. (07.831-0)
\$345.00 EA



3653339S **40**
No holes. Studs for brackets welded to back. Exc rear of Wagon or Sedan Delivery. (16.400-0)
\$345.00 EA

3658265S **41-46**
Polished stainless. No bolt holes (exc 41-42 COE & 46 1-1/2T w/ 160in. wheelbase). (07.831-0)
\$275.00 EA

Returns require a return authorization number, please call.

230T: Bumper



Format = Part No., Year, Description, original Chevrolet Part Book Group No., Price and Unit Measure.

Bumpers-Polished Stainless

3658265SA41-46
Polished stainless. No bolt holes. Fits 1/2T & 3/4T (original panels & Suburbans w/ doors had 1-1/2in. less arc). (07.831-0)

\$275.00 EA

3700438SS.....47-54
Smooth (no holes) Front, polished stainless. Also fits rear of Panel & Suburban. (07.831-0)

\$345.00 EA

3700438S.....47-54
Front, polished stainless. Also fits rear of Panel & Suburban. (07.831-2)

\$275.00 EA



3683350S.....47-53
Rear, polished stainless, exc Panel & Suburban. Nice! (07.831-0)

\$345.00 EA

Splash Apron-Front

Oversized shipping charges apply. Please call for rate.

606785F41-46
Bumper to grille. Fiberglass. (01.287-15)

\$95.00 EA



368414547-53
Bumper to grille. Steel (does not fit GMC) superior quality. (01.287-15)

\$100.00 EA

3684145C.....47-53
Bumper to grille. Chrome (does not fit GMC). (01.287-15)

\$200.00 EA



3684145F47-53
Bumper to grille. Fiberglass (does not fit GMC). (01.287-15)

\$95.00 EA

370122654
Bumper to grille. Steel (does not fit GMC). (01.287-15)

\$100.00 EA

Splash Apron-Front

3701226C.....54
Bumper to grille. Chrome (does not fit GMC). (01.287-15)

\$150.00 EA

3701226F54
Bumper to grille. Fiberglass (does not fit GMC). (01.287-15)

\$85.75 EA



3684145G47-53
Bumper to grille. Steel, GMC. (01.287-15)

\$100.00 EA

Roll Pan

Oversized shipping charges apply. Please call for rate.



3658265P41-46
Steel pan. Rear with license plate recess. Replaces back bumper for smooth look. (07.831-15)

\$125.00 EA

3683305P.....47-53
Steel pan. Rear with license plate recess. Replaces back bumper for smooth look. (07.831-15)

\$125.00 EA



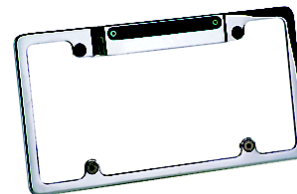
3683305FS.....47-53
Fiberglass pan. Smooth rear panel replaces back bumper (no license plate recess). (07.831-15)

\$95.00 EA

3705437P54
Steel pan. Rear with license plate recess. Replaces back bumper for smooth look. (07.831-15)

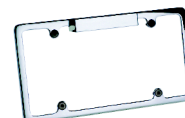
\$125.00 EA

License Plate Frame



BIS55520..... ALL
Billet aluminum with license light and 3rd brake light. (09.777-15)

\$70.00 EA



BIS55220 ALL
Billet aluminum, smooth with license light. (09.777-15)

\$50.00 EA



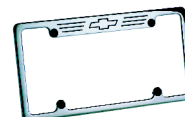
BIS55120 ALL
Billet aluminum, smooth. (09.777-15)

\$30.00 EA



BIS55320 ALL
Billet aluminum with Chevy Bowtie & license light. (09.777-15)

\$55.00 EA



BIS55623 ALL
Billet aluminum with Chevy Bowtie. (09.777-15)

\$35.00 EA



986710L ALL
Polished aluminum lighted w/ bowtie comes with hardware. (09.778-15)

\$60.00 EA

230T

Providing part #'s speeds up your order, improves accuracy, and helps us maintain low prices.

See Illustration Index for core charge information and a list of abbreviations. For Body Model information, see 5T. 143



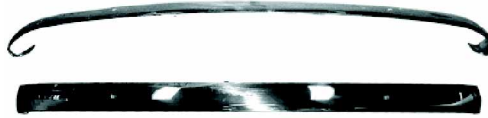
230T: Bumper

Format = Part No., Year, Description, original Chevrolet Part Book Group No., Price and Unit Measure.

Restoration Parts

Bumpers-Triple Plated Chrome

Oversized shipping charges apply. Please call for rate.



594648 **37**
Fits Master & Commercial 1/2 ton thru 1 ton. (07.831-0)
\$295.00 EA



3847305 **38-39**
Front or Rear. (07.831-0)
\$295.00 EA



3653339 **40**
Front or Rear. Exc rear of Wagon or Sedan Delivery. (07.831-0)
\$295.00 EA

3658265 **41-46**
Front. Exc 41-42 COE & 46 1-1/2T w/ 160in. wheelbase. (07.831-0)
\$265.00 EA

3658265A **41-46**
Rear. 1/2T & 3/4T (original panels & Suburbans w/ doors had 1-1/2in. less arc). (07.831-0)
\$265.00 EA



3700438 **47-54**
Front. Also fits rear of panel and Suburban. (07.831-15)
\$150.00 EA

3700438D **47-54**
Front. Also fits rear of panel and Suburban. Some chrome defects around bumper bolt holes. Great for a daily driver. (07.831-0)
\$100.00 EA

Bumpers-Triple Plated Chrome



3683350 **47-53**
Rear. Exc panel & Suburban. (07.831-15)
\$178.50 EA

Bumpers-Chrome



3705437 **54**
Rear (chrome) nice. (07.831-15)
\$191.50 EA

Bumpers-Painted

3700438P **47-54**
Front (painted) also rear of panel and Suburban. (07.831-15)
\$120.00 EA

Grommets-Bumper



3658003 **41-46**
Front bumper. (07.792-15)
\$16.50 PR



599743 **39-46**
Rear bumper panel, Suburban (2 pcs). (07.792-15)
\$22.25 PR

Seal



3690257 **47-54**
Body to rear bumper panel or Suburban. (07.833-15)
\$20.00 EA

Bumper Guard



597827 **38-39**
Front or rear bumper. (07.828-15)
\$41.25 EA

Bumper Guard



986113 **47-54**
Front or rear (accessory). (07.828-15)
\$60.00 L&R



986113R **47-54**
Front or rear (accessory). Rubber face. Includes mounting hardware. (07.828-15)
\$25.00 EA

Bolt-Bumper Guard



597825A **37**
1-1/8in. x 2-1/2in. (07.829-15)
\$7.75 EA



597825 **38-39**
1-3/8in. x 2-1/2in. (07.829-15)
\$7.75 EA

Bumper Bolt



594206 **37-46**
With oval head bolt, nut, flat & lock washers, as original. (07.874-15)
\$8.00 EA



594205 **37-46**
With oval head bolt, marsden nut, flat & lock washers, as original. (07.874-15)
\$12.50 EA



3695907 **47-54**
With standard bolt, nut, flat & lock washers, as original. (07.874-4)
\$4.50 EA



3695907C **47-54**
Chrome w/ standard nut & washers. (07.874-15)
\$2.25 EA

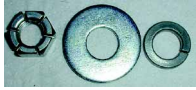
Returns require a return authorization number, please call.

230T: Bumper



Format = Part No., Year, Description, original Chevrolet Part Book Group No., Price and Unit Measure.

Bumper Bolt



125366ALL
With Washers.
(08.917-2)
\$2.50 SET

Bumper Bracket



59471137
Front (07.836-15)
\$155.50 PR



594154 37
Rear (07.836-15)
\$155.00 PR



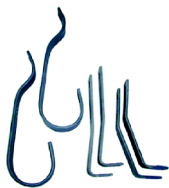
350590 38-39
Front (07.836-15)
\$155.50 PR



597872 38-39
Rear (07.836-15)
\$164.50 PR



365368140
Front (07.836-15)
\$155.50 PR

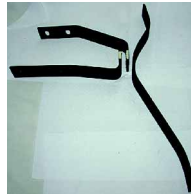


365386240
Rear (07.836-15)
\$164.50 SET

Bumper Bracket



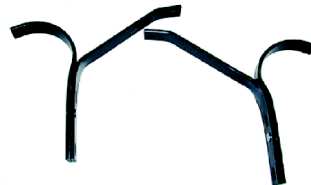
365805341-46
Front (07.836-15)
\$105.00 PR



599382B41-46
Rear (07.836-15)
\$105.00 SET



3701949 47-54
Front (1/2T & 3/4T).
(07.836-15)
\$87.00 PR



3684827B47-54
Rear (1/2T). (07.836-15)
\$85.50 SET



368483347-54
Rear (3/4 & 1T). (07.836-15)
\$140.00 SET

Splash Apron-Rear



3690258A 47-53
Fits over bumper brackets. Steel.
(07.833-15)
\$150.00 EA

License Plate Bracket



595805 37-40
Front (07.796-15)
\$22.00 EA



60535841-46
Front (07.796-15)
\$22.00 EA



384743947-53
Front (07.796-15)
\$8.00 EA



3847439C47-53
Front (chrome).
(07.796-3)
\$20.00 EA



3847440A 54
Front (07.796-2)
\$12.50 EA



3707021 54-59
Includes license light
rear. (02.705-3)
\$50.00 EA



Note: Rear License Plate Bracket see Tail Light Bracket Section 110T.

License Fastener



985094 ALL
Glass jewel reflector.
Specify Red or Green (2
pcs) . (09.777-15)
\$9.25 Pair



985094P ALL
Plastic jewel reflector.
Red (2 pcs).
(09.777-15)
\$2.00 PR

230T

Providing part #'s speeds up your order, improves accuracy, and helps us maintain low prices.

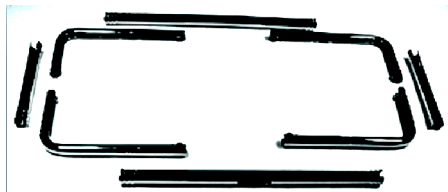
See Illustration Index for core charge information and a list of abbreviations. For Body Model information, see 5T. 145



230T: Bumper

Format = Part No., Year, Description, original Chevrolet Part Book Group No., Price and Unit Measure.

License Plate Frame



986708 **ALL**
Telescoping (8 pcs), 2 ribs on end of each piece. Polished stainless. Original accessory 48-55. (09.777-15)
\$52.50 EA

License Plate Frame



986710 **ALL**
Year on top and "Chevrolet" on bottom of frame. Choose 1937-1954. Specify year when ordering. (2 pcs). (09.777-0)
\$13.00 SET

Odds & Ends

Please call for availability on all Odds & Ends parts; once part is sold, it may no longer be in stock.

3656466 **41-46**
Bumper Bracket Front Outer NOS
(17*000-0)
\$20.00 EA

3683663 **47-55**
Bumper Bracket Front & Rear Inner Left
(17*000-0)
\$20.00 EA

350623 **37-40**
Bumper Bracket Front (All 1-1/2T Exc COE) (17*000-0)
\$20.00 EA

3683665 **47-55**
Bumper Bracket Front & Rear Outer Left
(17*000-0)
\$20.00 EA

Dear Sir:

I started my 1946 chevy 1/2 ton truck in October 2004 and finished in spring 2005. My two assistants Dale Bryant and Norm Ferris where invaluable help to me in all categories. They both know so much. I loved doing the restoration and of course bought all my parts from you. I wonder if you might consider putting a picture of the truck in your magazine? The story is quite simple: The truck was in North Carolina, moved to Penna. and somewhat restored. My friend bougt it in 1990 and sold it to me in 2004. I did the complete restoration over the next winter with my expert assistants who have done many, many cars in the past. Please check my invoices and you will see the truck really is a chevy of the 40's. Thanks for all your help and knowledge.

Sincerely,

Gary
Gary O. Reynolds
1-25-06



Returns require a return authorization number, please call.

240T: Grilles, Grille Hardware & Related



Format = Part No., Year, Description, original Chevrolet Part Book Group No., Price and Unit Measure.

Grilles

Note: Oversize shipping charges apply on all Grilles. Please call for rates.

1937 Grille-Billet Aluminum Bars

595112BNC.....37
Chromed bars. Narrow spacing (1/4in. space). (01.266-0)
\$1,150.00 EA



595112BNP 37
Fully polished. Narrow bar spacing (1/4in. space). (01.266-0)
\$825.00 EA



595112BNF..... 37
Polished (front bars only). Narrow bar spacing (1/4in. space). (01.266-0)
\$700.00 EA

595112BWF.....37
Polished (front of bars only). Standard bar spacing (3/8in. space). (01.266-0)
\$550.00 EA

595112BWP37
Fully polished. Standard bar spacing (3/8in. space). (01.266-0)
\$650.00 EA

595112BWC37
Chromed. Standard bar spacing (3/8in. space). (01.266-0)
\$1,000.00 EA

1937 "Gangster Grille"



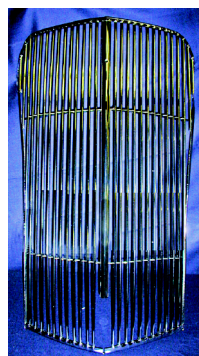
595112LS 37
Laser cut. Polished stainless for street rod. (01.266-15)
\$550.00 EA



595112LP 37
Laser cut. Bare steel for street rod. (01.266-15)
\$360.00 EA

1937 Grille

59511237
Bare steel like original. (01.266-15)
\$325.00 EA



595112C 37
Chrome like original. (01.266 -0)
\$575.00 EA



594996..... 37
Like original. (01.268-15)
\$33.00 EA

1937 Crank Hole Cover



595039.....37
(01.274-15)
\$27.50 EA

1937 Grille Center Strip



594996S..... 37
Street rod (no holes for emblem or crank). (01.268-15)
\$82.50 EA

1937 Grille-Side Moulding



594721 37
Side moulding. Cut to length. (01.268-15)
\$96.25 L&R

1937 Clips-Moulding



595539.....37
4 per side moulding (4 piece set). (01.269-4)
\$5.00 SET

1937 Grille Emblem



595376 37
Chrome. (01.303-0)
\$55.00 EA

240T

Providing part #'s speeds up your order, improves accuracy, and helps us maintain low prices.

See Illustration Index for core charge information and a list of abbreviations. For Body Model information, see 5T. 147



240T: Grilles, Grille Hardware & Related

Format = Part No., Year, Description, original Chevrolet Part Book Group No., Price and Unit Measure.

1938 "Gangster Grille"

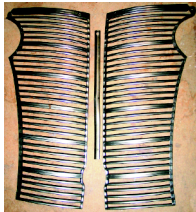


597829LS.....38
Laser cut. Polished stainless for street rod. (01.266-15)
\$550.00 EA



597829LP.....38
Laser cut. Bare steel for street rod. (01.266-15)
\$395.00 EA

1938 Grille



597829.....38
Bare steel like original. (01.266-15)
\$288.75 EA

1938 Crank Hole Cover



597719.....38
2 pieces (01.274-15)
\$33.00 SET

1938 Grille Center Strip



597988.....38
(01.268-15)
\$33.00 EA

1938 Grille Center Strip Clip



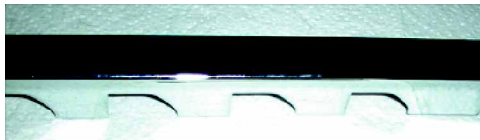
597463.....38
Clips for center strip. Uses 2. (01.269-0)
\$5.50 PR

1939 Grille



350422NC.....39
W/ center strip (bare steel). (01.266-15)
\$265.00 EA

1939 Grille Center Strip



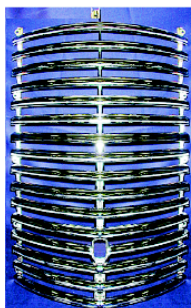
580814.....39
21-3/4in. (01.268-15)
\$40.00 EA

1939 Grille Lettering



350422L.....39
Top grille bar-vinyl. (01.266-15)
\$20.00 EA

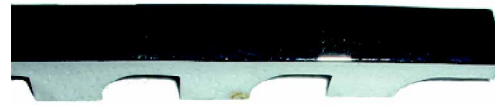
1940 Grille



Chrome Grill Shown

3653523NC.....40
W/ center strip (bare steel). (01.266-15)
\$265.00 EA

1940 Grille Center Strip



3653529.....40
20-1/4in. (01.268-15)
\$40.00 EA

1940 Grille Lettering



3653523A.....40
(01.266-15)
\$20.00 EA

1941-46 Grille



3657169.....41-46
Upper-chrome (not for show). (01.266-15)
\$350.00 EA

3657169NC.....41-46
Upper-bare steel. (01.266-15)
\$175.00 EA

1941-46 Grille



3657185.....41-46
Upper & lower, chrome (not for show). (01.266-15)
\$725.00 EA



3657185NC.....41-46
Upper & lower. Bare steel. (01.266-15)
\$450.00 SET

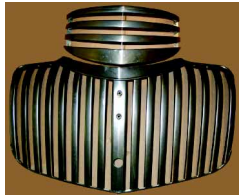
Returns require a return authorization number, please call.

240T: Grilles, Grille Hardware & Related



Format = Part No., Year, Description, original Chevrolet Part Book Group No., Price and Unit Measure.

1941-46 Grille



3657185NCNL.....41-46
Upper & Lower. Bare steel without logo.
(01.266-15)
\$395.50 EA

1941-46 Screw Set

3657169A.....41-46
Upper grille to lower grille. (01.266-15)
\$3.75 SET



3651169 41-46
Upper grille to fender.
(01.269-15)
\$3.75 SET

1941-46 Moulding Clips



597522A 41-46
For moulding above
lower grille (8 pcs).
(08.005-3)
\$4.50 SET

1941-46 Grille Emblem



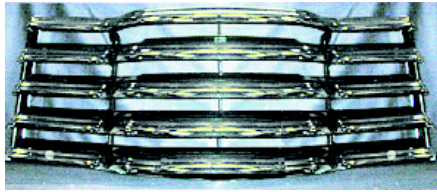
3657269 41-46
Lower. (01.303-15)
\$25.50 EA

1941-46 Grille Lettering



3657186.....41-46
Red vinyl. (01.266-15)
\$20.00 SET

1947-53 Grille



384734047-53
Chrome-detailed, preassembled very nice.
(01.266-15)
\$400.00 EA



3847340P 47-53
Painted. Nice detail.
Comes preassembled.
(01.266-15)
\$325.00 EA

369374447-53
Bare steel (foreign made) not for show.
(01.266-15)
\$289.25 EA



3847340G47-53
Chrome-detailed, preassembled very nice.
GMC (exc COE) (01.266-15)
\$495.00 EA

Bolt Kit



3650205B 47-53
Grille (01.269-3)
\$16.00 SET

1954 Grille



3700339B.....54
Chrome plated. Comes assembled
(01.268-15)
\$745.00 EA

1954 Grille

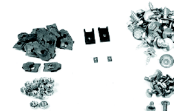


3701112A 54
Unplated center grille
bar (01.268-15)
\$85.00 EA



3701112 54
Chrome center grille
bar. (01.268-15)
\$100.00 EA

1954 Bolt Kit



3701113A 54
Grille (84 pieces).
(01.269-15)
\$20.00 EA

Decals Grille



3710929C 54
For chrome grille & hood emblem.
(08.055-15)
\$9.00 SET



3710929P 54
For painted grille & hood emblem.
(08.055-15)
\$9.00 SET



3701185C 55
(1st series) for chrome grille & hood
emblem. (08.055-0)
\$11.00 SET

240T

Providing part #'s speeds up your order, improves accuracy, and helps us maintain low prices.

See Illustration Index for core charge information and a list of abbreviations. For Body Model information, see 5T. 149



240T: Grilles, Grille Hardware & Related

Format = Part No., Year, Description, original Chevrolet Part Book Group No., Price and Unit Measure.

Decals Grille

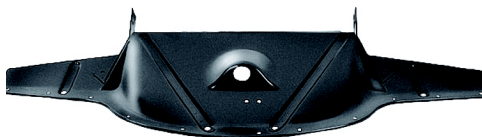
3701185P **55**
(1st series) for painted grille & hood emblem. (08.055-15)
\$12.00 SET

Grille Shell

602395 **37**
Fiberglass (sent freight collect, call for rate). (01.263-15)
\$298.00 EA

Grille Filler Panel

3693744F **47-53**
Upper grille fiberglass. (01.286-15)
\$70.00 EA



3683583 **47-53**
Lower grille, EDP coated steel. (01.286-15)
\$120.00 EA



3693743F **47-53**
Lower grille fiberglass. (01.286-15)
\$120.00 EA

Filler Panel



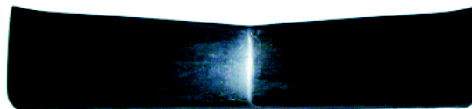
3664734 **41-46**
Upper grille baffle. Fits between upper grille & radiator. Fiberglass. (01.286-15)
\$70.00 EA

Panel Below Grille



3680810 **41-46**
Fiberglass (01.266-0)
\$62.70 EA

Panel Below Grille

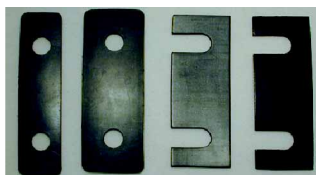


3680810S **41-46**
Fiberglass w/out bumper cutouts street rod application. (01.266-15)
\$57.00 EA

3680810G **41-46**
GMC fiberglass. (01.266-15)
\$76.00 EA

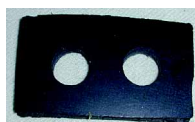
3680810GS **41-46**
GMC fiberglass w/out bumper cutouts street rod application. (01.266-15)
\$76.00 EA

Core Support Pads & Shims

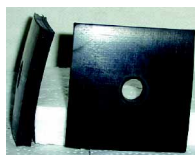


367314 **39-46**
Radiator core support mount. (01.270-4)
\$9.00 SET

Pads & Shims-Radiator



3684763A **47-49**
Radiator core support mount. (01.270-3)
\$6.00 SET



3684763 **50-54**
Radiator core support mount. (01.270-2)
\$4.50 PR

Core Support Bolt Kit



3676480 **41-54**
Radiator core support to frame. (01.270-4)
\$2.50 SET

Brace (V-Rod)



594773 **37-38**
Stainless Steel. (01.309-15)
\$88.00 EA

Odds & Ends

Please call for availability on all Odds & Ends parts; once part is sold, it may no longer be in stock.

10281 **47-53**
Grille GMC (Good Used) (00.000-0)
\$400.00 EA

602395U **37**
Grille shell and Radiator with hood ornament with top and side moulding (Used). Grille shell has rust at bottom. (01.263-15)
\$300.00 EA

3693745U **50-53**
Grille GMC (Some rust) (22:000-0)
\$125.00 EA

3790 **47-53**
Headlight knob w/ shaft, good used (2.485-0)
\$8.00 EA

3870 **37-46**
Headlight Switch, 37-38 Pass & 40-46 Truck (9-0)
\$55.00 EA

5936674 **46-48**
Rim (trim ring) for spotlight (NOS) (7-0)
\$15.00 EA

365365 **39-40**
Top grille molding used (Good condition) (-0)
\$125.00 EA

3700339 **54**
Upper grille moulding, w/ chevrolet (Used) (01.266-0)
\$125.00 EA

Returns require a return authorization number, please call.

250T: Hood & Related



Format = Part No., Year, Description, original Chevrolet Part Book Group No., Price and Unit Measure.

Street Rod Parts

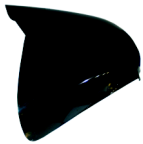
Hood-Fiberglass

602345F **37**
1-piece top section. (08.001-15)
\$386.00 EA



602985F **38**
1-piece top section.
(08.001-15)
\$386.00 EA

3701466F **47-55**
1-piece top section. (08.000-15)
\$428.00 EA



3692127 **47-55**
Smooth without inner
liner, customer will need
to provide their own.
(08.001-15)
\$300.00 EA

3692127G **47-55**
GMC smooth without inner liner, customer
will need to provide their own. (08.001-15)
\$300.00 EA

Hood Sides-Fiberglass

602346F **37**
Smooth (08.001-15)
\$190.00 PR

602346FS **37**
W/ recessed scoop. (08.001-15)
\$202.00 PR

602986F **38**
Smooth (08.001-15)
\$190.00 PR

Hood Center Strip



3681480 **47-55**
For hood bullnose-steel w/ clips will not fit
GMC. (08.015-15)
\$80.00 EA



3681480SG **47-55**
Stainless steel w/ clips.
GMC (08.015-15)
\$60.00 EA

Hood Center Strip



3681480S **47-55**
Stainless steel w/ clips. Will not fit GMC.
(08.015-15)
\$69.00 EA

Bullnose



3701990B **47-53**
Replaces center strip & hood ornament.
57in. length, polished aluminum, w/ clips
(\$5 addl UPS tube fee). (08.015-15)
\$30.00 EA

Restoration Parts

NEW! Hood -Steel



3701466 **47-55**
1/2 ton. 2-piece top (no under hood brace).
(08.000-15)
\$475.00 EA

Hood Latch Lower Assembly



3682709C **47-53**
Complete chrome assembly. (08.080-15)
\$190.00 EA

Hood Latch Lower Assembly



3682709P **47-53**
Complete assembly, black. (08.080-15)
\$130.00 EA

Radiator Cap



370683 **34-36**
Seahorse gorgeous
(accessory).
(01.203-15)
\$170.00 EA

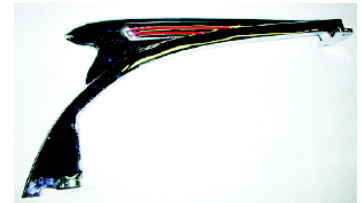
Hood Ornament



595591 **37**
(01.265-15)
\$200.25 EA



598015 **38**
(01.265-15)
\$200.25 EA



350805 **39-40**
(01.265-0)
\$190.00 EA

250T

Providing part #'s speeds up your order, improves accuracy, and helps us maintain low prices.

See Illustration Index for core charge information and a list of abbreviations. For Body Model information, see 5T. 151



250T: Hood & Related

Format = Part No., Year, Description, original Chevrolet Part Book Group No., Price and Unit Measure.

Hood Ornament



986162 47-53
Accessory (original 49-52). (01.265-15)
\$110.00 EA

986162G 47-55
GMC accessory. (01.265-15)
\$291.50 EA



986982 53
Accessory (01.265-15)
\$249.00 EA

Hood Emblem



3684340C 47-53
Front of Hood - Chrome. (08.055-15)
\$39.00 EA



3684340 47-53
Front of Hood - Stainless. (08.055-15)
\$50.00 EA

Gasket-Hood Emblem



3699021B 47-53
Hood emblem.
(08.055-2)
\$5.00 EA



3710929A 54
Hood emblem.
(08.055-2)
\$5.00 EA

Decals-Hood Emblem



3699021A 47-53
Hood emblem set-script. (08.055-2)
\$6.00 EA

Decals-Grille



3710929C 54
For chrome grille & hood emblem.
(08.055-15)
\$9.00 SET



3710929P 54
For painted grille & hood emblem.
(08.055-15)
\$9.00 SET



3701185C 55
(1st series) for chrome grille & hood emblem. (08.055-0)
\$11.00 SET

3701185P 55
(1st series) for painted grille & hood emblem. (08.055-15)
\$12.00 SET

Hood Side Emblem



474797A 36-38
Bowtie painted-superior quality.
(08.039-15)
\$34.75 EA



474797 36-38
Bowtie all chrome. (08.039-15)
\$41.50 EA

Hood Side Emblem



3683134 47-48
Chevrolet Thriftmaster. (08.039-15)
\$14.75 EA



3699024 49-52
Chevrolet. (08.039-15)
\$36.00 PR



3692106 49-51
3100 (08.039-15)
\$10.25 EA

Returns require a return authorization number, please call.

250T: Hood & Related



Format = Part No., Year, Description, original Chevrolet Part Book Group No., Price and Unit Measure.

Hood Side Emblem



3700202 53-54
3100 (08.039-15)
\$30.00 PR

Hood Side Moulding



3657265 41-46
Left (08.005-0)
\$14.75 EA



3657266 41-46
Right (08.005-0)
\$14.75 EA

Hood Side Clips & Bolts



59752346 41-46
Does 1 moulding.
(08.005-4)
\$5.50 SET

Hood Handle



597521A 36-46
Stainless steel (36-39 cars) (08.030-15)
\$33.00 EA

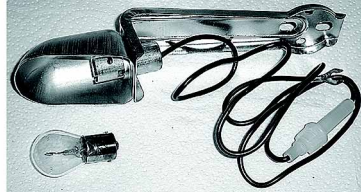
597521P 36-46
Plain steel, primed. Paintable, as original.
(08.030-15)
\$15.00 EA

Adhesive



01608 ALL
3M plastic & emblem adhesive (5 oz. tube).
(08.800-15)
\$11.50 EA

Underhood Light



986250 47-48
Super reproduction. (08:890-15)
\$67.00 EA

Hood Corners



3678834 37-38
Rubber front. (08.024-15)
\$11.50 PR

3678834 39-46
Rubber rear. (08.024-15)
\$11.50 PR

Bumpers (Rubber)



595304 37
Hood to grille shell (6 pcs). (08.024-3)
\$4.25 SET



3681093B 38-46
Hood to grille shell (6 pcs). (08.024-4)
\$5.25 SET



3676360B 47-54
Hood set (10 pcs).
(08.024-4)
\$8.75 SET

Hood To Cowl Seal



374969A 29-46
Webbing-also radiator shell to hood (9 ft).
(09.127-4)
\$12.00 EA



3658468A 41-46
2 44in. rubber strips.
(09.127-3)
\$10.25 PR

Hood To Cowl Seal

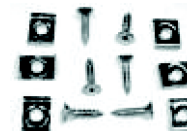


3688792 47-55
2 32-1/2in. rubber strips.
(09.127-3)
\$10.00 PR

Retainers w/ Screws



3654168S 29-46
For Hood To Cowl Seal stainless Steel (set of 6). (09.127-4)
\$13.00 SET



3654168S 47-54
For Hood To Cowl Seal Stainless Steel (set of 8). (09.127-4)
\$17.50 EA



3654168B 29-46
For hood-to-cowl seal. Chrome. (09.127-0)
\$8.00 EA

Hood To Grille Seal

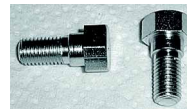


374969C 31-40
Webbing with wire insert. (09.127-2)
\$24.00 EA

Hood Hinge Bolt



3689234S 47-54
Stainless steel 5/8in. hex head, 7/16in. shoulder. Fits Comm & Utility (exc COE) (uses 4). (08.016-0)
\$18.00 SET



3688414 47-54
Shouldered-1/2in. hex head, 7/16in. shoulder commercial utility (exc COE) (uses 2). (08.016-15)
\$5.00 SET

250T

Providing part #'s speeds up your order, improves accuracy, and helps us maintain low prices.

See Illustration Index for core charge information and a list of abbreviations. For Body Model information, see 5T. 153



250T: Hood & Related

Format = Part No., Year, Description, original Chevrolet Part Book Group No., Price and Unit Measure.

Hood Hinge Bolt



3689234.....47-54
Steel. Shouldered-5/8in. hex head, 7/16in. shoulder commercial utility (exc COE) (uses 4). (08.016-3)
\$5.00 SET

Bracket-Hood Hinge



473987.....34-46
Hood hinge hold down (rear). (08.058-3)
\$13.00 EA

Hood Hinge

372828.....34-40
Chrome with fasteners (exc COE). (08.015-15)
\$94.50 SET

3657264.....41-46
Chrome with fasteners (exc COE). (08.015-15)
\$94.05 SET



3686039.....47-54
Upper & lower (left). (08.015-15)
\$44.00 SET



3686040.....47-54
Upper & lower (right). (08.015-15)
\$44.00 SET

Odds & Ends

Please call for availability on all Odds & Ends parts; once part is sold, it may no longer be in stock.

3681600N.....47-53
Center Strip, Hood NOS (Utility) (19<000-0)
\$75.00 EA

3689239.....47-53
Hood Hinge NOS left (19*000-0)
\$45.00 EA

3657264U.....41-46
Hood hinge (Used). (08.015-0)
\$60.00 EA

3716191.....55-59
Hood Lower latch plate NOS (08.080-0)
\$45.00 EA

595591U.....37
Hood ornament. Nice condition (Used) (1.265-0)
\$175.00 EA

3686039.....47-55
Hood link w/ spring-left (19.000-0)
\$15.00 EA

3681600N.....47-54
Hood center strip NOS painted (08.015-0)
\$75.00 EA

11540.....54
Mldg, Hood Center, P/u (36^000-0)
\$70.00 EA

Returns require a return authorization number, please call.

270T: Fenders, Fender Skirts, Fender Welting, Fender Gaskets, Mud Flaps, Hardware & Mouldings



Format = Part No., Year, Description, original Chevrolet Part Book Group No., Price and Unit Measure.

Street Rod Parts

Fender Front (Fiberglass)

Note: Fenders are made to order. \$7 packaging fee on each fender. Front fenders are sent freight collect.



594955L	37-38	Left.....	(08.130-15)	\$321.00	EA
594956R	37-38	Right.....	(08.130-15)	\$321.00	EA
599991L	39-40	Left.....	(08.130-15)	\$321.00	EA
599992R	39-40	Right.....	(08.130-15)	\$321.00	EA
3664961L	41-46	Left.....	(08.130-15)	\$327.00	EA
3664962R	41-46	Right.....	(08.130-15)	\$327.00	EA
3682657L	47-53	Left.....	(08.130-15)	\$339.00	EA
3682658R	47-53	Right.....	(08.130-15)	\$339.00	EA

Fender Rear (Fiberglass)

Note: Rear fenders are made to order. \$7 additional packing fee on each fender. Oversize shipping charges apply. Please call for rates.



594181L	37-38	Left.....	(08.203-15)	\$249.00	EA
594182R	37-38	Right.....	(08.203-15)	\$249.00	EA
594181W	37-38	Left 2in. Wider.....	(08.203-15)	\$279.00	EA
594182W	37-38	Right 2in. Wider.	(08.203-15)	\$279.00	EA
599295L	39	Left (1/2, 3/4 & 1T).....	(08.203-15)	\$279.00	EA
599296R	39	Right (1/2, 3/4 & 1T).....	(08.203-15)	\$279.00	EA
599295W	39	Left 2in. wider (1/2, 3/4 & 1T).(08.203-15)...	(08.203-15)	\$271.50	EA
599296W	39	Right 2in. wider (1/2, 3/4 & 1T).(08.203-15).	(08.203-15)	\$279.00	EA
599121L	39-46	Left (Panel, Suburban). ...	(08.164-15)	\$261.00	EA
599122F	39-46	Right (Panel, Suburban)..	(08.164-15)	\$261.00	EA
3681977L	40-46	Left, exc 1T.....	(08.203-15)	\$261.00	EA
3681978R	40-46	Right, exc 1T.....	(08.203-15)	\$261.00	EA
3681977W	40-46	Left, 2in. wider, exc 1T.	(08.203-15)	\$279.00	EA
3681978W	40-46	Right, 2in. wider, exc 1T... ..	(08.203-15)	\$279.00	EA
3682835L	47-54	Left (all pickups).	(08.203-15)	\$279.00	EA
3682836R	47-54	Right (all pickups).	(08.203-15)	\$279.00	EA
3682835W	47-54	Left, 2in. wider, all pickups.(08.203-15).....	(08.203-15)	\$297.00	EA
3682836W	47-54	Right, 2in. wider, all pickups.(08.203-15).....	(08.203-15)	\$297.00	EA
3684691L	47-54	Left (Panel, Suburban). ...	(08.203-15)	\$297.00	EA

Fender Rear (Fiberglass)

3684692R 47-54 Right (Panel, Suburban). . (08.203-15) \$297.00 EA

Fender Brace

3683947A 47-54 Rear, for 2in. widened fenders.(08.212-3) \$11.00 EA

Stand-Headlight Bucket

350777F 37 Fiberglass, left. (02.544-15) \$59.00 EA
 350778F 37 Fiberglass, right. (02.544-15) \$59.00 EA

Inner Fender Panel (Fiberglass)

595889F 37-38 Left, front..... (08.164-15) \$119.00 EA
 595890F 37-38 Right, front..... (08.164-15) \$119.00 EA
 3664975F 41-46 Left, front..... (08.164-15) \$166.00 EA
 3664976F 41-46 Right, front..... (08.164-15) \$166.00 EA

Note: For inner fender panel black paint see Section 10T.

Restoration Parts

Fender Front (Steel)



3682481 **47-53**
 Left side. Metal. Exc COE. (08.130-0)
\$375.00 EA

3682482 **47-53**
 Right side. Metal. Exc COE. (08.130-0)
\$375.00 EA



3700181 **54-55**
 Left side. Metal. Fits 1st Series, Exc COE.
 (08.130-15)
\$375.00 EA

3700182 **54-55**
 Right side. Metal. Fits 1st Series, Exc COE. (08.130-15)
\$375.00 EA

Bolt & Washer Set

3682481BZ **47-55**
 Fender. Front, bolt kit zinc plated. (08.130-2)
\$12.00 EA

Inner Fender Panel-Front



3687381 **47-53**
 Left, steel. (08.153-15)
\$125.00 EA

3683076 **47-53**
 Right, steel. (08.153-15)
\$125.00 EA

270T

Providing part #'s speeds up your order, improves accuracy, and helps us maintain low prices.

See Illustration Index for core charge information and a list of abbreviations. For Body Model information, see 5T. 155



270T: Fenders, Fender Skirts, Fender Welting, Fender Gaskets, Mud Flaps, Hardware & Mouldings

Format = Part No., Year, Description, original Chevrolet Part Book Group No., Price and Unit Measure.

Fender Rear (Steel)

Note: Rear fenders are made to order. \$7 additional packing fee on each fender. Oversize shipping charges apply. Please call for rates.

- 3682835S** 47-54
Left (08.203-15)
\$456.00 EA
- 3682836S** 47-54
Right (08.203-15)
\$456.00 EA

Fender Gaskets

- 609725** 47-54
Fender to cowl (die cut). (08.205-4)
\$11.25 SET

Fender Welting



- 601726** ALL
1/4in. x 1-3/16in. 37-48 rear fenders use approx 15 ft. (08.205-3)
\$0.80 FT
- 601726C** ALL
Chrome mylar (1-1/4in. x 3/16in.) (08.205-4)
\$1.50 FT



- 601726S** ALL
W/ stainless steel bead (8 ft) (oversized shipping charges apply, please call for rates.) (08.205-15)
\$25.00 EA
- 601726A** 27-46
Set (4 fenders). (08.205-3)
\$17.75 SET
- 609275B** 47-54
Set (4 fenders) (optional). (08.205-3)
\$20.00 SET

Fender Welting

- 601726E** 37-54
Rear fenders (optional 47-54). (08.205-3)
\$16.00 PR
- 601726F** 37-54
Chrome mylar rear (optional 47-54). (08.205-4)
\$25.00 PR

Gasket Set



- 3701900A** 41-46
Inner panel w/ lower rear mount pads. (08.154-15)
\$23.00 SET



- 3701900C** 47-54
Inner panel & front fender (8 pcs). (08.154-2)
\$16.50 SET

Headlight Wire Grommet

- 3673139** 47-53
Fender inner panel. (09.775-4)
\$3.00 SET

Clutch Head Bolt

- 3681977B** 39-46
5/16in., nut, washer, attaches rear fender (3 pcs). (08.206-3)
\$1.50 SET
- 3676478** 47-54
5/16in., nut, washer, attaches rear fender (10 per fender) (3 piece set). (08.206-3)
\$1.50 SET
- 3681977** 47-54
5/16in., nut, washer fender brace (3 pcs). (08.206-3)
\$1.50 SET

Clutch Head Driver W/ Bits



- DRIVER** ALL
Magnetic driver w/ 5 bits (1/8in., 5/32in., 3/16in., 1/4in., 5/16in.) with Chevs imprint. (08.821-15)
\$22.25 SET

Clutch Head Bits

- 3685598**
1/8in. (1/4in. drive) (08.821-3)
\$4.00 EA
- 3685592**
5/32in. (1/4in. drive) (08.821-4)
\$4.00 EA
- 3685594**
3/16in. (1/4in. drive) (08.821-3)
\$4.00 EA
- 3685593**
1/4in. (1/4in. drive) (08.821-3)
\$4.00 EA
- 3685595**
5/16in. (1/4in. drive) (08.821-2)
\$6.00 EA

Clutch Bit Holder

- 3685596**
For your 1/4in. drive ratchet. Holds clutch head bits. (08.821-2)
\$6.00 EA

Fender Brace

- 3684841** 47-54
Front (08.144-15)
\$14.25 L&R
- 3683947** 47-54
Rear (08.212-2)
\$10.00 EA

Returns require a return authorization number, please call.

270T: Fenders, Fender Skirts, Fender Welting, Fender Gaskets, Mud Flaps, Hardware & Mouldings



Format = Part No., Year, Description, original Chevrolet Part Book Group No., Price and Unit Measure.

Mud Flaps

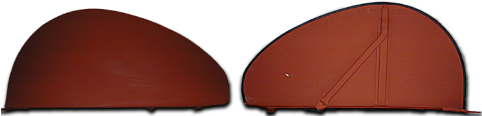


986905**ALL**
W/ Chevrolet in bow-tie
12in.x17in. (2 pcs).
(08.214-15)
\$37.25 PR

Fender Skirts



604503P**36-46**
New (teardrop style). Fabricated.
(08.175-15)
\$225.00 L&R

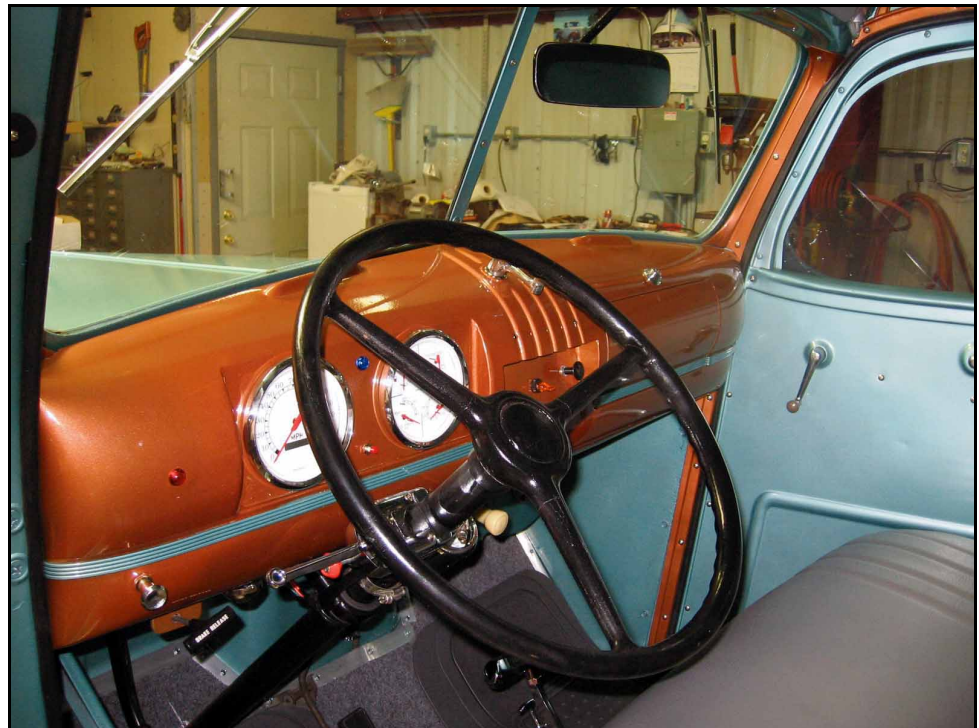


985641**36-46**
Fiberglass.Die stamped. (08.175-15)
\$498.00 L&R
604503F**47-54**
Fiberglass reproduction of 40's teardrop
style. Die stamped. (08.175-15)
\$291.25 L&R

Odds & Ends

Please call for availability on all Odds & Ends parts; once part is sold, it may no longer be in stock.

3682657U**47-53**
Front fender left used with inner panel,
used in good condition (08.130-0)
\$100.00 EA
3682658U**47-53**
Front fender right used with inner panel,
used in good condition (08.130-0)
\$100.00 EA
599121S**39-46**
Rear fender NOS left (08.203-0)
\$350.00 EA
3682481U**47-53**
Front left fender. Has holes cut for parking
light below headlight (Used) (8.130-0)
\$200.00 EA
3694962U**47-53**
Right front fender (Used) (8.130-0)
\$200.00 EA



1941 1/2 Ton—Robin Simmons, California

270T

Providing part #'s speeds up your order, improves accuracy, and helps us maintain low prices.

See Illustration Index for core charge information and a list of abbreviations. For Body Model information, see 5T. 157

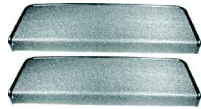


290T: Running Board Gaskets & Step Plates

Format = Part No., Year, Description, original Chevrolet Part Book Group No., Price and Unit Measure.

Running Board Step Plate

Note: Running Boards and Rocker Panels can be found in Section 295T.



350274B.....47-54
(super repro) very rare genuine chevrolet accessory (08.316-15)
\$73.75 L&R



350274A..... ALL
Stainless steel rim w/ rubber insert (7-5/8in. x 10-11/16in.) (08.316-0)
\$82.50 L&R



350274C..... ALL
Die cast with bowtie (5-5/16in. x 10-7/8in.) (08.316-15)
\$60.00 L&R



350274..... ALL
Cast w/ bowtie, kick guard (6-5/8in. x 8-3/4in. w/ 2in. foot scraper) (08.316-15)
\$55.00 L&R

Running Board Bolt Kit



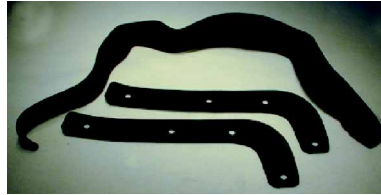
3687271B.....37-54
(08.299-4)
\$11.75 SET

Gaskets-Running Board To Fender

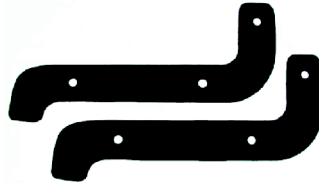


3656703.....39-40
Running board to fenders (4) (08.299-15)
\$12.00 SET

Gaskets-Running Board To Fender



3656703A.....41-46
Running board to fenders (4) (08.299-2)
\$16.00 SET



3687271A.....47-54
Running board to rear fender (08.299-15)
\$3.50 PR

Running Board To Cab Seal



60395540.....33-40
(anti-squeak) to body (120in.) (08.237-2)
\$7.50 SET

60395546.....41-46
Running board to body (panel & Suburban) (120in.) (08.237-2)
\$7.50 SET

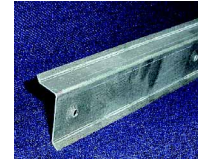


3685433A.....47-54
Running board to body (panel & Suburban) (08.205-15)
\$22.50 PR



3685433.....47-54
Running board to cab (exc panel & Suburban) (08.205-15)
\$16.25 PR

Metal Retainer



3685433B.....47-55
Running board to cab seal (08.205-15)
\$9.00 EA

Screws



3685433C.....47-54
For running board to cab seal retainer (18 piece) (08.205-4)
\$2.25 SET

Running Board Mat



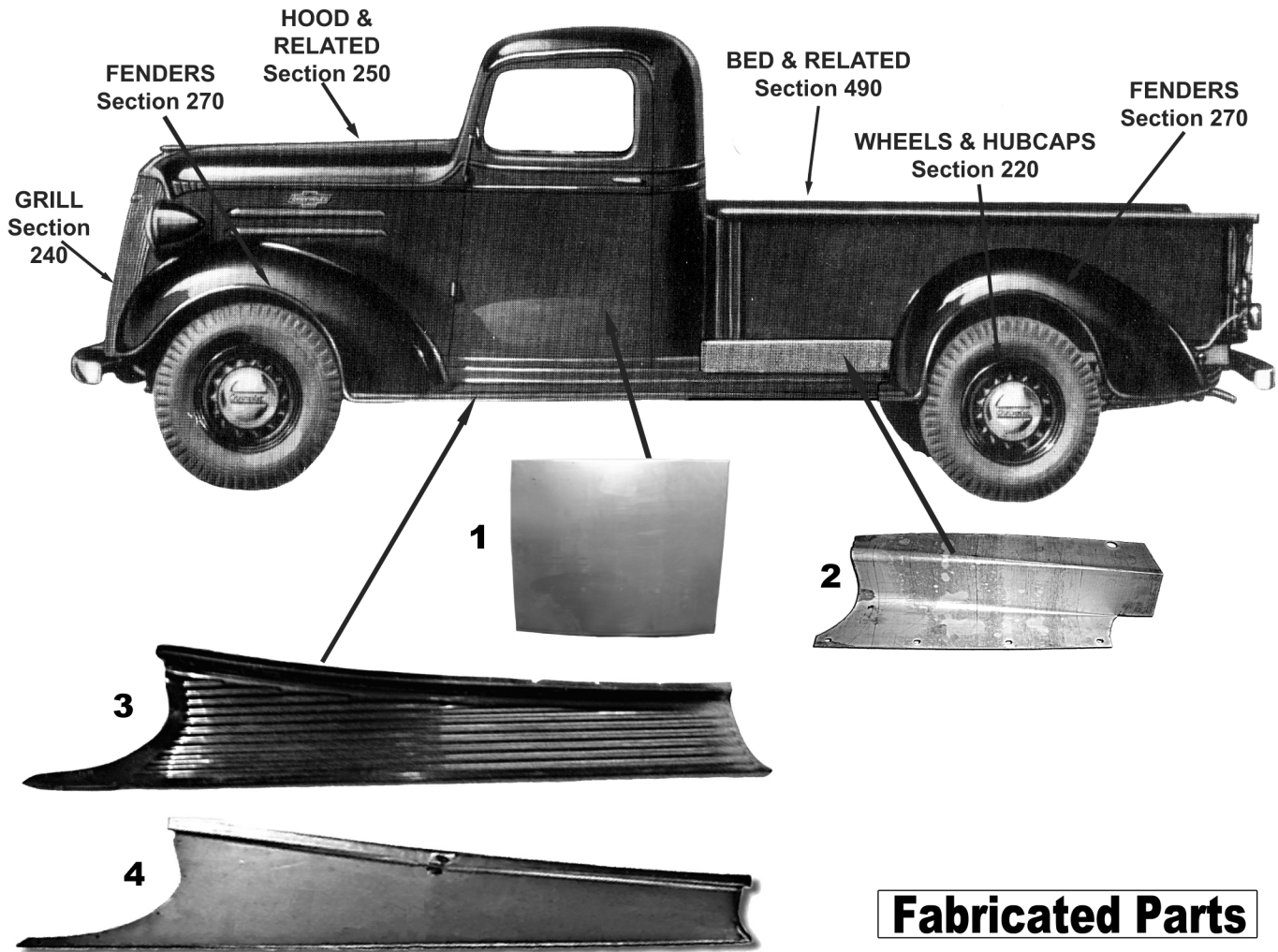
GL16..... ALL
Rubber repair kit. Repairs chipped running board rubber & other rubber materials. 2-part epoxy, 16 oz. (10.000-15)
\$34.25 EA

Returns require a return authorization number, please call.

295T: 1937-39 Truck Body Parts



Format = Part No., Year, Description, original Chevrolet Part Book Group No., Price and Unit Measure.



Fabricated Parts

1: Door Skin

602455	36-38	Outer left, 26" x 32.5".....	(16.150-15)	\$110.00	EA
602456	36-38	Outer right, 26" x 32.5".....	(16.150-15)	\$110.00	EA

1: Door Patch Panel

603339	39-46	Outer left (34.5in. wide x 25in. high).....	(16.150-15)	\$110.00	EA
3666518	39-46	Outer right.....	(16.150-15)	\$110.00	EA

2: Splash Apron

599731L	37-39	Left-1/2T.....	(08.228-15)	\$36.75	EA
599732R	37-39	Right-1/2T.....	(08.228-15)	\$36.75	EA

3: Running Boards w/ Built-in Mounting Points (Fiberglass)

594265S	37-38	Fiberglass-stock 1/2T.....	(08.299-15)	\$404.00	PR
594266F	37-38	Fiberglass-smooth 1/2T.....	(08.299-15)	\$356.00	PR
594265W	37-38	Fiberglass-smooth 1/2T (2in. wider).....	(08.299-15)	\$374.00	PR
599578	39-40	Fiberglass-stock 1/2T.....	(08.299-0)	\$367.50	PR
599578FS	39-40	Fiberglass-smooth 1/2T.....	(08.299-15)	\$380.00	PR
599578FW	39-40	Fiberglass-smooth 1/2T (2in. wider).....	(08.299-15)	\$398.00	PR

4: Running Boards w/ Built-in Mounting Points (Steel)

594266S	37-38	Smooth steel 1/2T.....	(08.299-15)	\$375.50	PR
594266SW	37-38	Smooth steel 1/2T (2in. wider).....	(08.299-15)	\$398.75	PR
599578S	39-40	Smooth steel 1/2T.....	(08.299-15)	\$375.50	PR
599578SW	39-40	Smooth steel 1/2T (2in. wider).....	(08.299-15)	\$398.75	PR

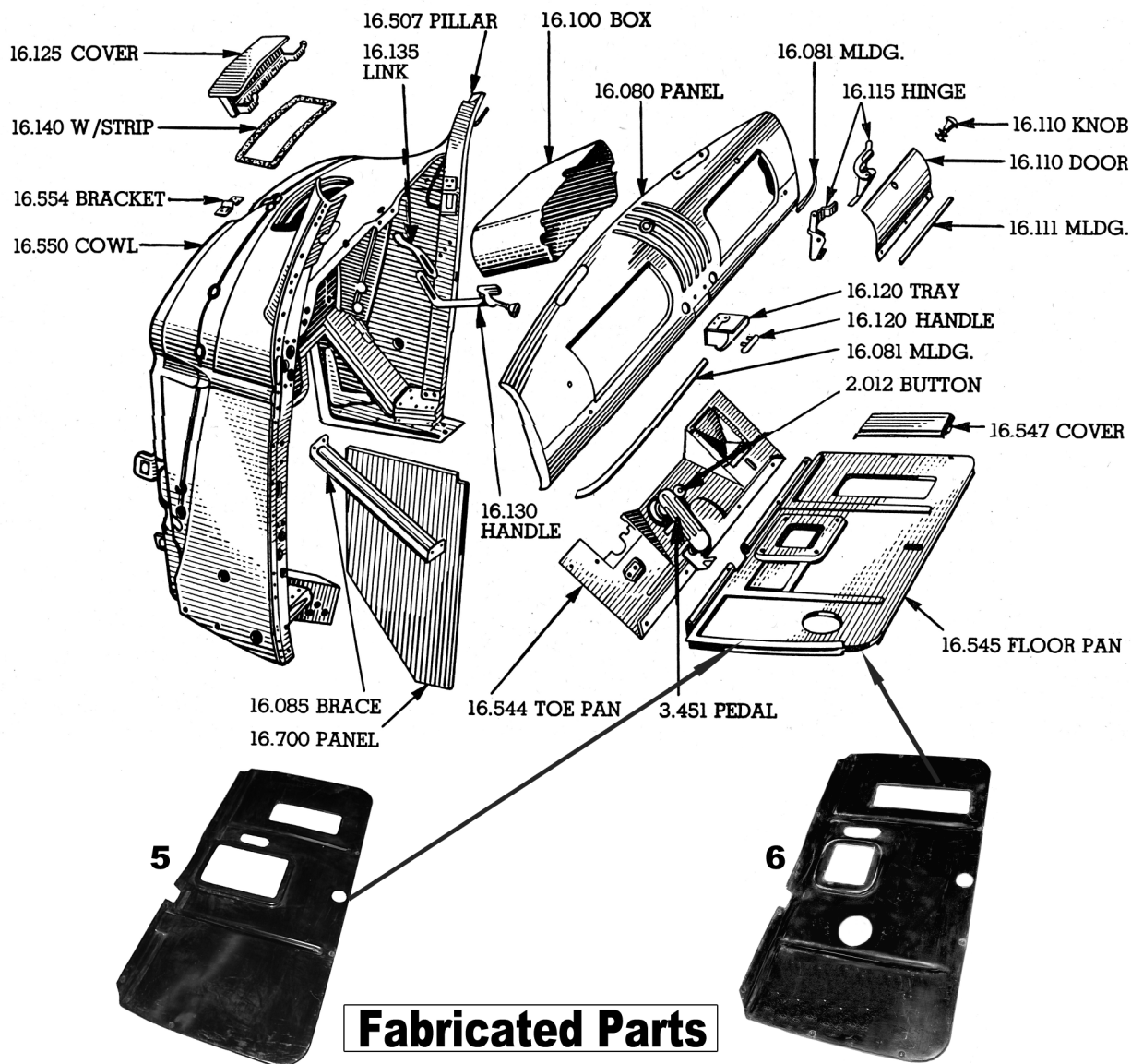
Providing part #'s speeds up your order, improves accuracy, and helps us maintain low prices.

See Illustration Index for core charge information and a list of abbreviations. For Body Model information, see 5T. 159



295T: 1937-39 Truck Body Parts

Format = Part No., Year, Description, original Chevrolet Part Book Group No., Price and Unit Measure.



5: Floorboard

594993

37-38

Door to door (fiberglass) 4-speed(16.545-15)

\$55.00 EA

6: Floorboard

3653211

39-40

Door to door (fiberglass) 4-speed(16.545-15)

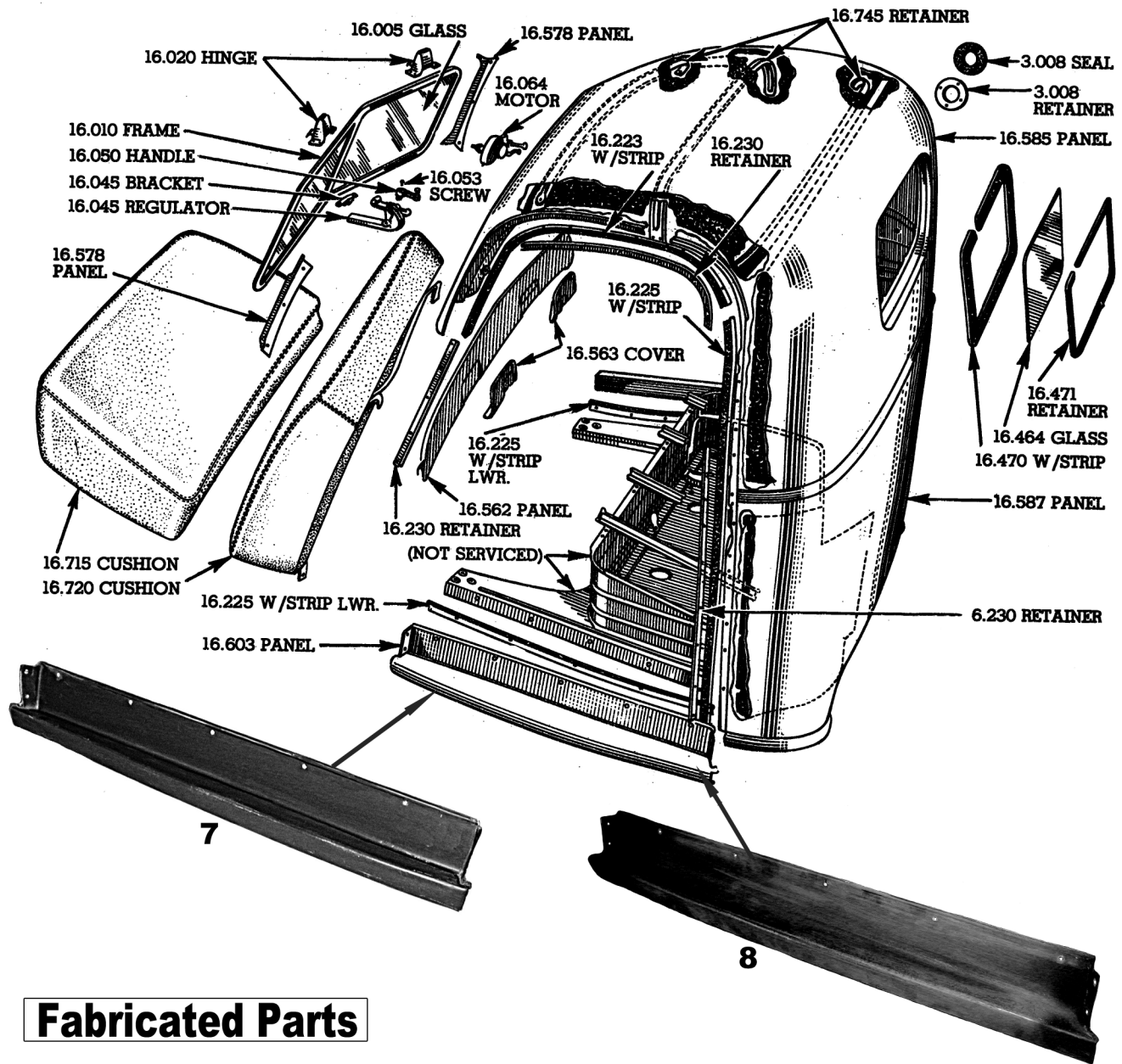
\$55.00 EA

Returns require a return authorization number, please call.

295T: 1937-39 Truck Body Parts



Format = Part No., Year, Description, original Chevrolet Part Book Group No., Price and Unit Measure.



Fabricated Parts

7: Rocker Panel

477143	36-38	Left-fiberglass	(16.603-15)	\$70.00	EA
477144	36-38	Right-fiberglass	(16.603-15)	\$70.00	EA

8: Rocker Panel

598655	39-46	Left-fiberglass	(16.603-15)	\$70.00	EA
598656	39-46	Right-fiberglass	(16.603-15)	\$70.00	EA

295T

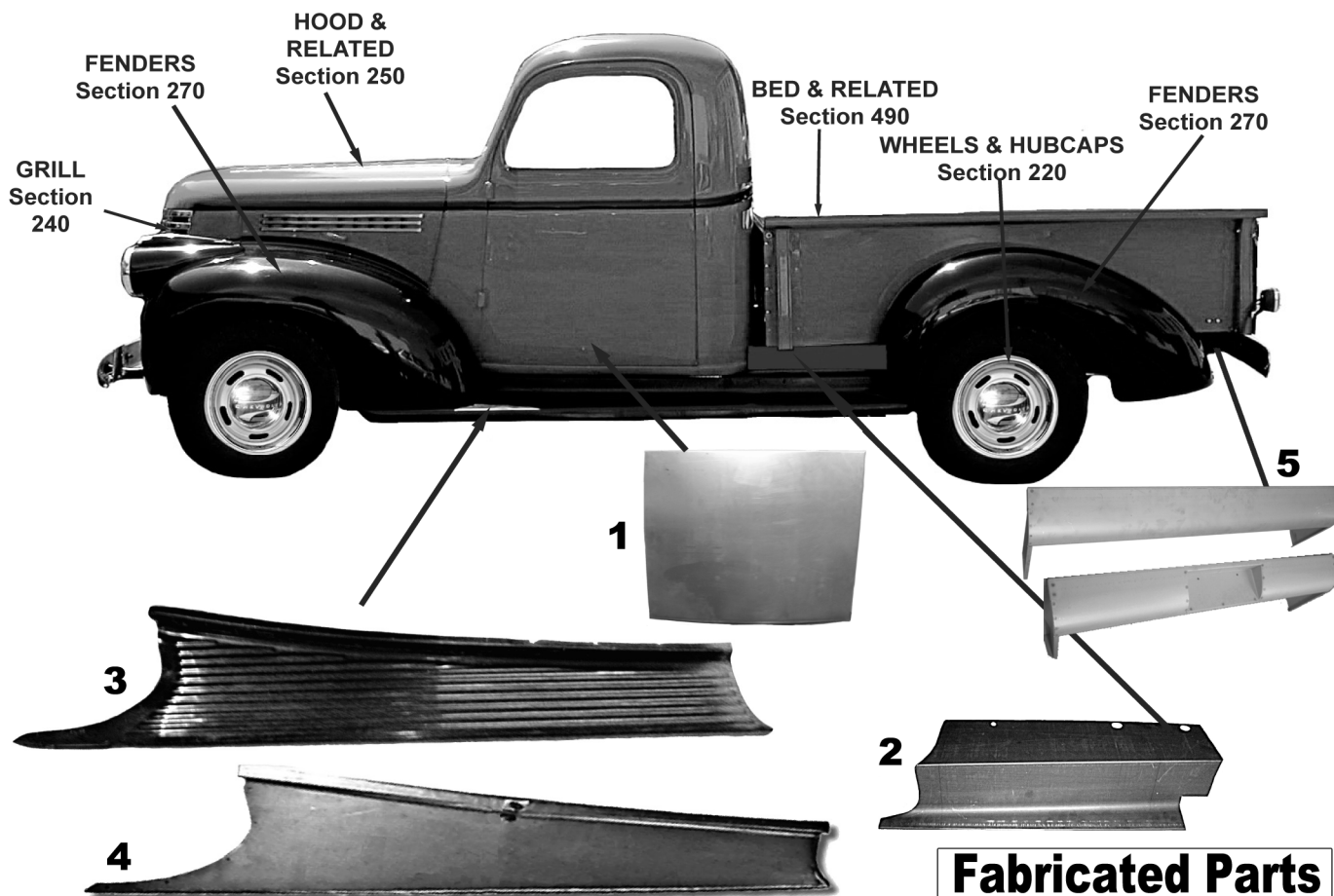
Providing part #'s speeds up your order, improves accuracy, and helps us maintain low prices.

See Illustration Index for core charge information and a list of abbreviations. For Body Model information, see 5T. 161



295T: 1940-46 Truck Body Parts

Format = Part No., Year, Description, original Chevrolet Part Book Group No., Price and Unit Measure.



Fabricated Parts

1: Door Patch Panel

603339	39-46	Outer left (34.5in wide x 25in high)	(16.150-15)	\$110.00	EA
3666518	39-46	Outer right	(16.150-15)	\$110.00	EA

2: Splash Apron

3654023L	40-46	Left-1/2T	(08.228-15)	\$36.75	EA
3654024R	40-46	Right-1/2T	(08.228-15)	\$36.75	EA
3654025L	40-46	Left-3/4T	(08.228-15)	\$49.00	EA
3654026R	40-46	Right-3/4T	(08.228-15)	\$49.00	EA

3: Running Boards w/ Built-in Mounting Points (Fiberglass)

599578	39-40	Stock 1/2T	(08.299-0)	\$367.50	PR
599578FS	39-40	Smooth 1/2T	(08.299-15)	\$380.00	PR
599578FW	39-40	Smooth 1/2T (2in. wider)	(08.299-15)	\$398.00	PR
3656702T	41-46	Stock 1/2T	(08.299-0)	\$367.50	PR
3656702F	41-46	Smooth 1/2T	(08.299-15)	\$380.00	PR
3656702W	41-46	Smooth 1/2T	(08.299-15)	\$398.00	PR
3656915F	41-46	Stock 3/4T long bed.	(08.299-0)	\$525.00	PR

4: Running Boards w/ Built-in Mounting Points (Steel)

599578S	39-40	Smooth, 1/2T	(08.299-15)	\$375.50	PR
599578SW	39-40	Smooth, 1/2T (2in. wider)	(08.299-15)	\$398.75	PR
3656702S	41-46	Smooth, 1/2T	(08.299-15)	\$375.50	PR
3656702SW	41-46	Smooth, 1/2T (2in. wider)	(08.299-15)	\$398.75	PR

5: Rear Pan

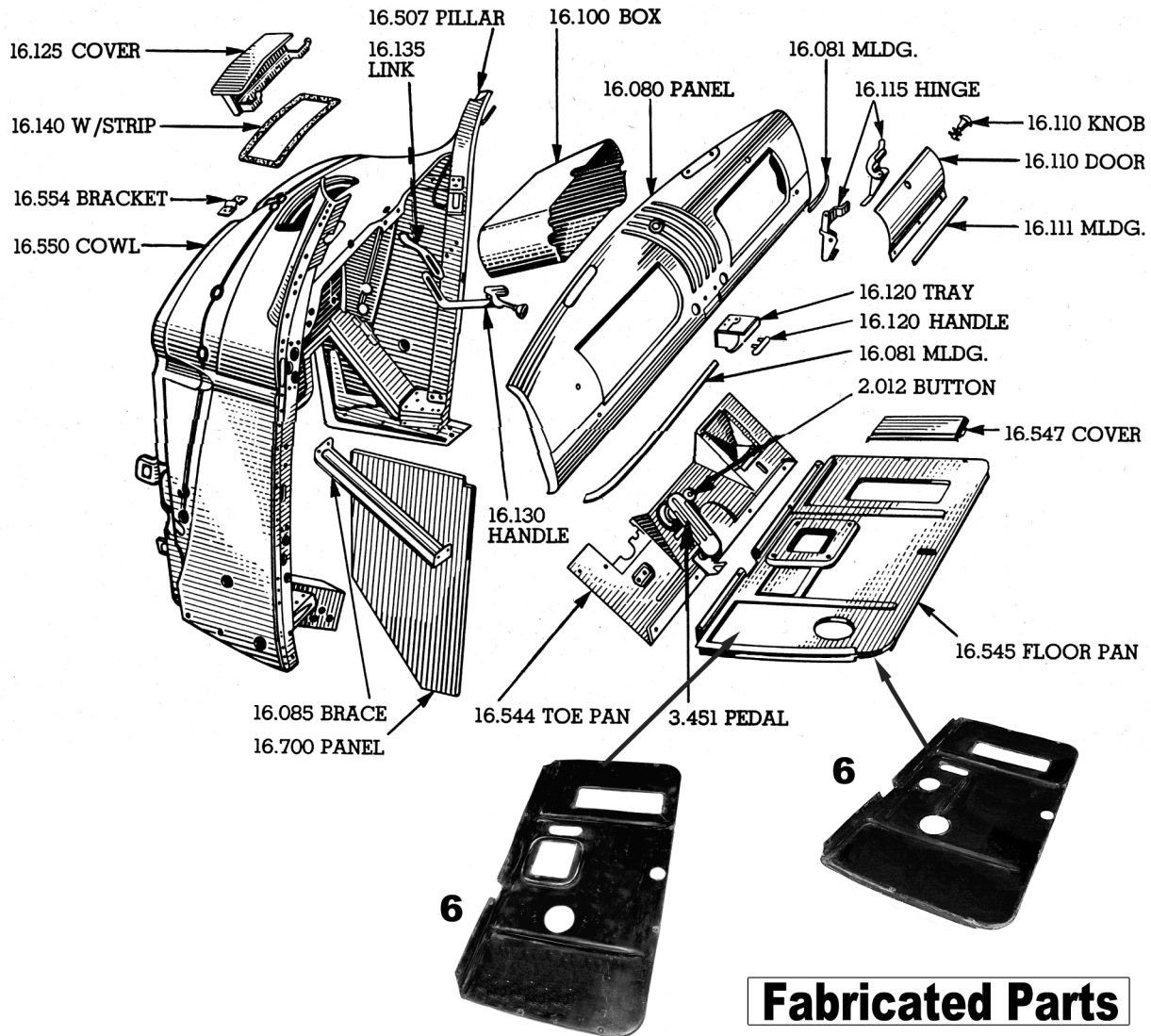
3658265PS	41-46	Steel pan. Rear without license plate recess. Replaces back bumper for smooth look.	(07.831-15)	\$75.00	EA
3658265P	41-46	Steel pan. Rear with license plate recess. Replaces back bumper for smooth look.	(07.831-15)	\$125.00	EA

Returns require a return authorization number, please call.

295T: 1940-46 Truck Body Parts



Format = Part No., Year, Description, original Chevrolet Part Book Group No., Price and Unit Measure.



6: Floorboard

3653211	39-40	Door to door (fiberglass) 4-speed.....	(16.545-15)	\$55.00	EA
3681279	41-46	Door to door (fiberglass), 3-speed.....	(16.545-15)	\$55.00	EA
3681279A	41-46	Door to door (fiberglass) 4-speed.....	(16.545-15)	\$55.00	EA
187694B	41-46	For floor board (21 pcs).....	(16.542-15)	\$4.75	SET

295T

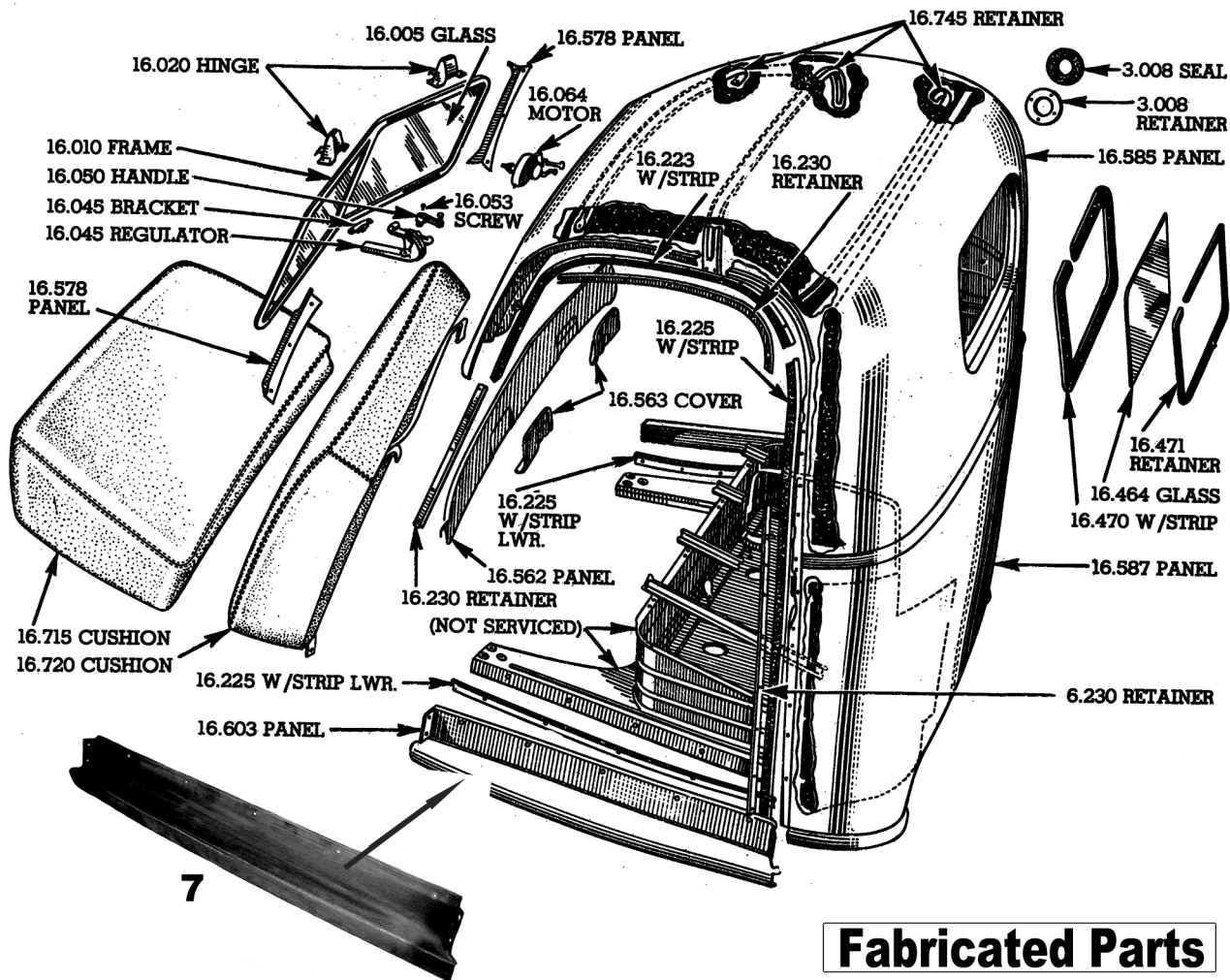
Providing part #'s speeds up your order, improves accuracy, and helps us maintain low prices.

See Illustration Index for core charge information and a list of abbreviations. For Body Model information, see 5T. 163



295T: 1940-46 Truck Body Parts

Format = Part No., Year, Description, original Chevrolet Part Book Group No., Price and Unit Measure.



Fabricated Parts

7: Rocker Panel

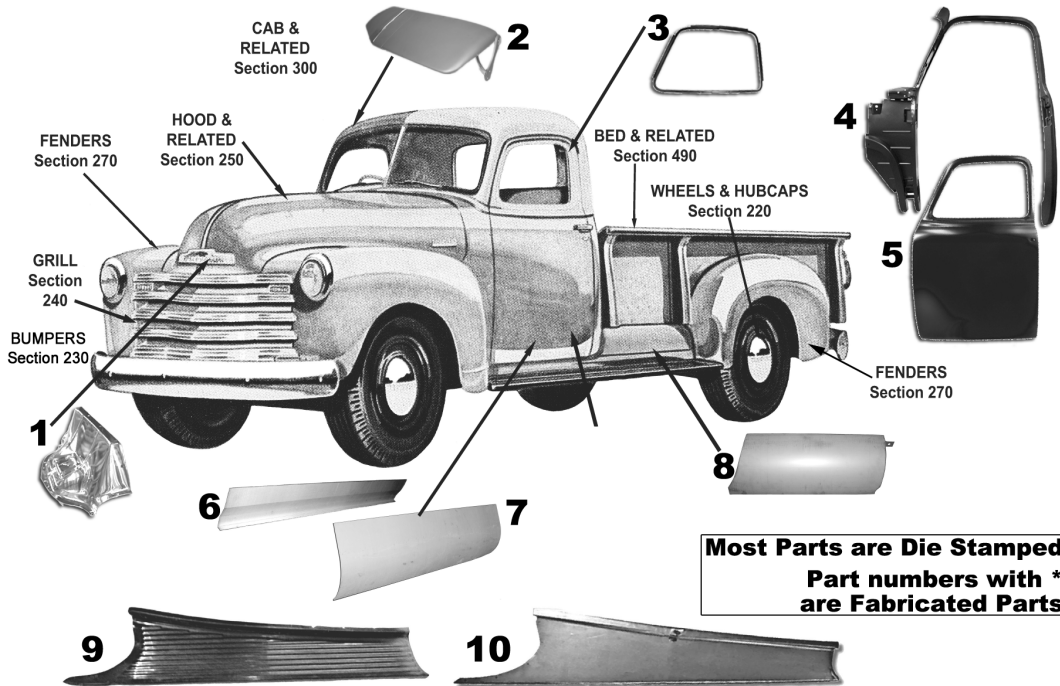
598655	39-46	Left-fiberglass.....	(16.603-15)	\$70.00	EA
598656	39-46	Right-fiberglass.....	(16.603-15)	\$70.00	EA

Returns require a return authorization number, please call.

295T: 1947-54 Truck Body Parts



Format = Part No., Year, Description, original Chevrolet Part Book Group No., Price and Unit Measure.



**Most Parts are Die Stamped
Part numbers with *
are Fabricated Parts**

1: Hood Latch Lower Assembly

3682709C	47-53	Chrome. Complete assembly.	(08.080-15)	\$190.00	EA
3682709P	47-53	Black. Complete assembly.	(08.080-15)	\$130.00	EA

2: Sunvisor-Exterior

986877F *	37-53	Aluminum, Fulton repro w/ mounting hardware & instructions. Adjustable. Fabricated.....	(10.201-15)	\$490.00	EA
986877FSD *	37-53	Steel, Fulton repro w/ mounting hardware & instructions. Adjustable. Fabricated.....	(10.201-15)	\$490.00	EA

3: Window Reveal Moulding

3684847	47-54	Left door.....	(16.185-15)	\$69.00	EA
3684848	47-54	Right door.....	(16.185-15)	\$69.00	EA

3: Drip Rail

3684289	47-54	Left door. Window drip rail.....	(16.642-15)	\$45.00	EA
3684290	47-54	Right door. Window drip rail.....	(16.642-15)	\$45.00	EA

4: Door Pillar

3807227B	47-53	Outer, left side w/ side cowl panel & windshield frame.....	(16.578-15)	\$400.00	EA
3807228B	47-53	Outer, right side w/ side cowl panel & windshield frame.....	(16.578-15)	\$400.00	EA

5: Door - Metal

3684147	47-50	Left side minus trim & hardware. EDP black finish. Exc COE.....	(16.150-15)	\$450.00	EA
3684148	47-50	Right side minus trim & hardware. EDP black finish. Exc COE.....	(16.150-15)	\$450.00	EA
3695437	51	Left side minus trim & hardware. EDP black finish. Exc COE.....	(16.150-15)	\$450.00	EA
3695438	51	Right side minus trim & hardware. EDP black finish. Exc COE.....	(16.150-15)	\$450.00	EA
3810915	52-55	Left side minus trim & hardware. EDP black finish. Exc COE.....	(16.150-15)	\$450.00	EA
3810916	52-55	Right side minus trim & hardware. EDP black finish. Exc COE.....	(16.150-15)	\$450.00	EA

6: Door Patch Panel (Inner)

3684147DL	47-54	Inner bottom, left (superior).....	(16.150-15)	\$44.75	EA
3684147DR	47-54	Inner bottom, right (superior).....	(16.150-15)	\$44.75	EA
3684147C *	47-54	Inner bottom (4in. high 32-1/2in. long). Either side. Fabricated.....	(16.150-2)	\$30.00	EA

7: Door Patch Panel (Outer)

3684147BL	47-54	Outer bottom left (superior).....	(16.150-2)	\$46.00	EA
3684147BR	47-54	Outer bottom right (superior).....	(16.150-2)	\$46.00	EA
3684147A *	47-54	Outer bottom (10in. high 36in. long). Either side. Fabricated.....	(16.150-2)	\$36.00	EA

NOTE: Part Sections 8-10 continue on the next page.

Providing part #'s speeds up your order, improves accuracy, and helps us maintain low prices.

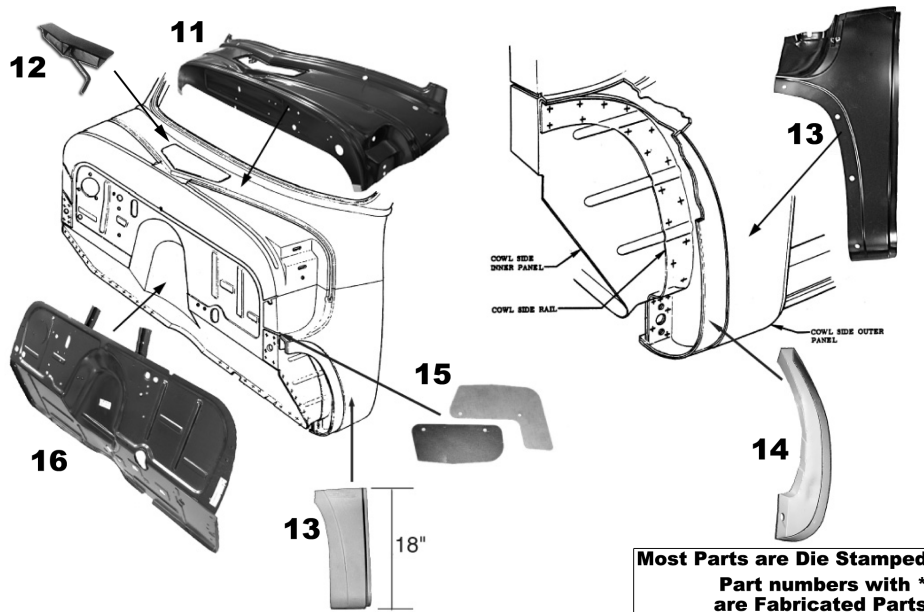
See Illustration Index for core charge information and a list of abbreviations. For Body Model information, see 5T. **165**

295T



295T: 1947-54 Truck Body Parts

Format = Part No., Year, Description, original Chevrolet Part Book Group No., Price and Unit Measure.



8: Splash Apron-Side

3676427L *	47-53	Left-1/2T. Fabricated.	(08.228-15)	\$36.75	EA
3676428R *	47-53	Right-1/2T. Fabricated.	(08.228-15)	\$36.75	EA
3676429L *	47-53	Left-3/4T. Fabricated.	(08.228-15)	\$45.00	EA
3676430R *	47-53	Right-3/4T. Fabricated.	(08.228-15)	\$45.00	EA
3700361L *	54	Left-1/2T. Fabricated.	(08.228-15)	\$40.00	EA
3700362R *	54	Right-1/2T. Fabricated.	(08.228-15)	\$40.00	EA
3700365L *	54	Left-3/4T. Fabricated.	(08.228-15)	\$45.00	EA
3700366R *	54	Right-3/4T. Fabricated.	(08.228-15)	\$45.00	EA

9: Running Boards w/ Built-in Mounting Points (Fiberglass)

3682721F	47-54	Fiberglass-stock 1/2T.	(08.299-15)	\$399.00	PR
3682721S	47-54	Fiberglass-smooth 1/2T.	(08.299-15)	\$386.00	PR
3682721W	47-54	Fiberglass-smooth 1/2T (2in. wider).....	(08.299-15)	\$398.00	PR
3682729FR	47-54	Fiberglass-stock (ribbed) 3/4T.....	(08.299-15)	\$419.00	PR
3682729F	47-54	Fiberglass-smooth 3/4T.....	(08.299-15)	\$399.00	PR

10: Running Boards w/ Built-in Mounting Points (Steel)

3687271SC	47-54	Chrome, ribbed steel. 1/2T.....	(08.299-15)	\$475.00	PR
3687271	47-54	Steel (super repro) 1/2T.	(07.016-15)	\$500.00	PR
3687271S *	47-54	Smooth steel 1/2T. Fabricated.	(08.299-15)	\$375.50	PR
3687271SW *	47-54	Smooth steel 1/2T (2in. wider). Fabricated.	(08.299-15)	\$398.75	PR

11: Cowl Panel - Metal Upper

3696433A	47-54	Nice quality replacement panel. Full top of cowl.....	(16.551-15)	\$250.00	EA
----------	-------	---	-------------	----------	----

12: Cowl Vent

3682919	47-53	Assembly with handle.	(16.125-15)	\$125.00	EA
---------	-------	----------------------------	-------------	----------	----

13: Cowl Patch Panel Metal Outer

3683003SL	47-54	Left-superior (no louvers).	(16.551-15)	\$99.50	EA
3683002SR	47-54	Right-superior (w/ louvers).....	(16.551-15)	\$99.50	EA
3683003B	47-54	Lower-left	(16.551-15)	\$32.75	EA
3683002B	47-54	Lower-right.....	(16.551-15)	\$32.75	EA

14: Cab Front Lower Corner

3687291 *	47-54	Arc-shaped firewall corners (behind tires) left.. Fabricated.	(16.551-15)	\$52.00	EA
3684032 *	47-54	Arc-shaped firewall corners (behind tires) right.. Fabricated.	(16.551-15)	\$52.00	EA

15: Metal Filler Panel

3685642 *	47-54	Firewall to inner panel.. Fabricated.	(08.155-15)	\$8.50	PR
-----------	-------	--	-------------	--------	----

16: Firewall (steel)

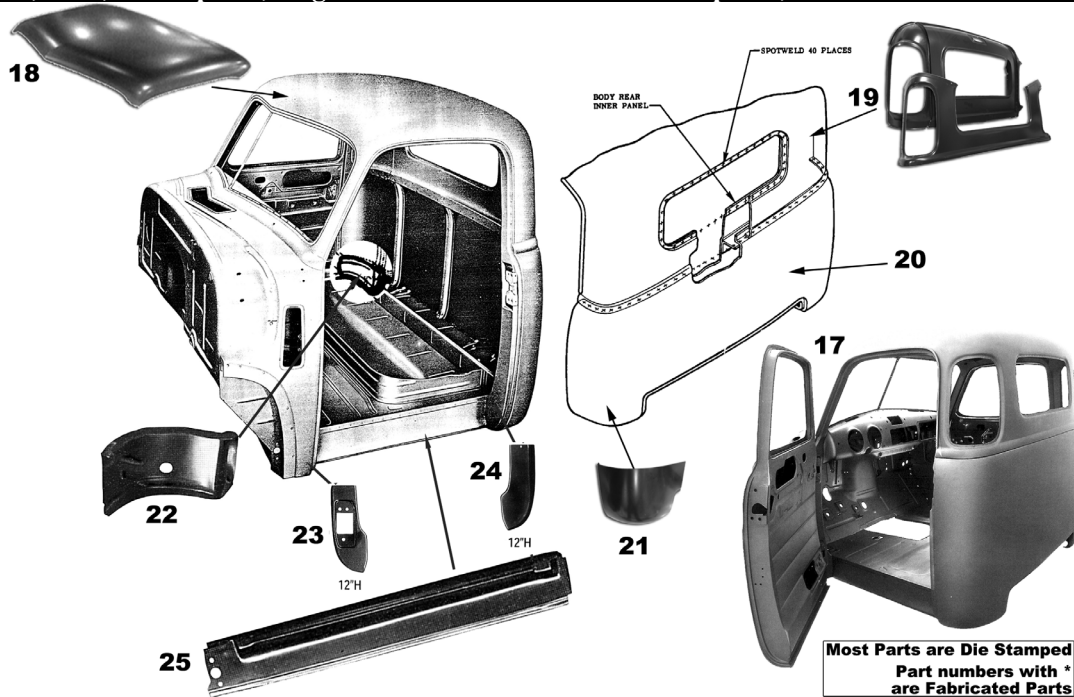
3696815A	47-54	Complete repro steel firewall. Black EDP finish.....	(16.551-15)	\$250.00	EA
----------	-------	--	-------------	----------	----

Returns require a return authorization number, please call.

295T: 1947-54 Truck Body Parts



Format = Part No., Year, Description, original Chevrolet Part Book Group No., Price and Unit Measure.



17: All Steel Cab w/ Mounted Hinged Doors

TR47PUT	47-54	5-window Chevy steel cab. Black primed. Includes windshield center bar and 47-50 doors (non-vent window) mounted w/ hinges (latch hardware not included).	(16.585-0)	\$8,995.00	EA
TR52PUT	47-53	5-window Chevy steel cabw/ 52-53 doors mounted with hinges.	(16.585-0)	\$8,995.00	EA

18: Cab Roof

3693099A	47-54	Metal replacement panel.....	(16.585-15)	\$320.00	EA
----------	-------	------------------------------	-------------	----------	----

19: Cab Back Panel - Upper

3693099	47-54	Upper exterior panel for 5 window cabs.....	(16.585-15)	\$355.00	EA
3809365B	47-54	Upper interior panel for 5 window cabs.....	(16.585-15)	\$325.00	EA
3693001	47-54	Upper exterior panel for 3 window cabs.....	(16.589-15)	\$355.00	EA
3809173B	47-54	Upper interior panel for 3 window cabs.....	(16.585-15)	\$325.00	EA

20: Cab Back Panel - Lower

3693003A	47-54	Exterior panel below back window.....	(16.587-15)	\$450.00	EA
----------	-------	---------------------------------------	-------------	----------	----

21: Cab Corner Patch Panel - Outer

3693003A	47-54	Outer left, rear.....	(16.587-15)	\$47.50	EA
3693002A	47-54	Outer right.....	(16.587-15)	\$47.50	EA

22: Cab Corner Patch Panel - Inner

3693003B	47-54	Inner left.....	(16.587-15)	\$35.25	EA
3693002B	47-54	Inner right.....	(16.587-15)	\$35.25	EA

23: Door Hinge Post Lower

3700481	47-54	Left.....	(16.603-15)	\$38.00	EA
3700482	47-54	Right.....	(16.603-15)	\$38.00	EA

24: Door Latch Post Lower

3703551	47-54	Left.....	(16.163-15)	\$38.00	EA
3703552	47-54	Right.....	(16.603-15)	\$38.00	EA

25: Rocker Panel-Outer

3692809S	47-54	Left (superior).....	(16.603-15)	\$54.25	EA
3692810S	47-54	Right (superior).....	(16.603-15)	\$54.25	EA
3692809 *	47-54	Left (fabricated).....	(16.603-15)	\$38.00	EA
3692810 *	47-54	Right (fabricated).....	(16.603-15)	\$38.00	EA

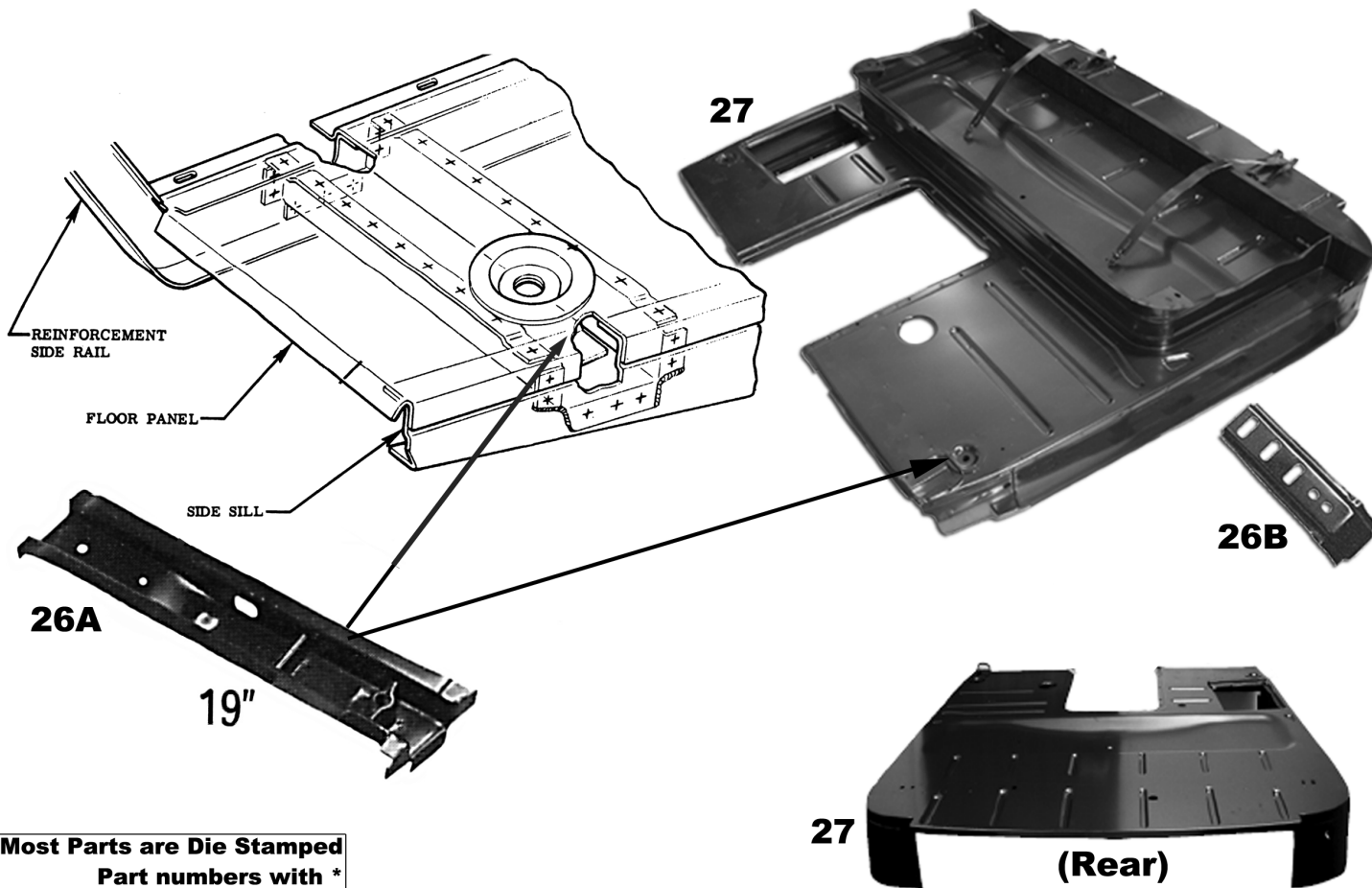
Providing part #'s speeds up your order, improves accuracy, and helps us maintain low prices.

See Illustration Index for core charge information and a list of abbreviations. For Body Model information, see 5T. 167



295T: 1947-54 Truck Body Parts

Format = Part No., Year, Description, original Chevrolet Part Book Group No., Price and Unit Measure.



**Most Parts are Die Stamped
Part numbers with *
are Fabricated Parts**

26A: Cab Mount Brace (Front)

3809493S	47-54	Left-die stamped (superior).....	(16.545-2)	\$44.75	EA
3809494S	47-54	Right-die stamped (superior).....	(16.545-2)	\$44.75	EA

26B: Cab Mount Brace (Rear)

3809495	47-54	Connects cross brace	(16.545-15)	\$36.75	EA
---------	-------	----------------------------	-------------	---------	----

27: Floor Pan

3713907AC	47-54	Complete Metal Floor Pan w/ tank straps, seat riser and floor braces. Excellent quality.	(16.000-15)	\$550.00	EA
3713907A	47-54	With braces.....	(16.000-15)	\$490.00	EA

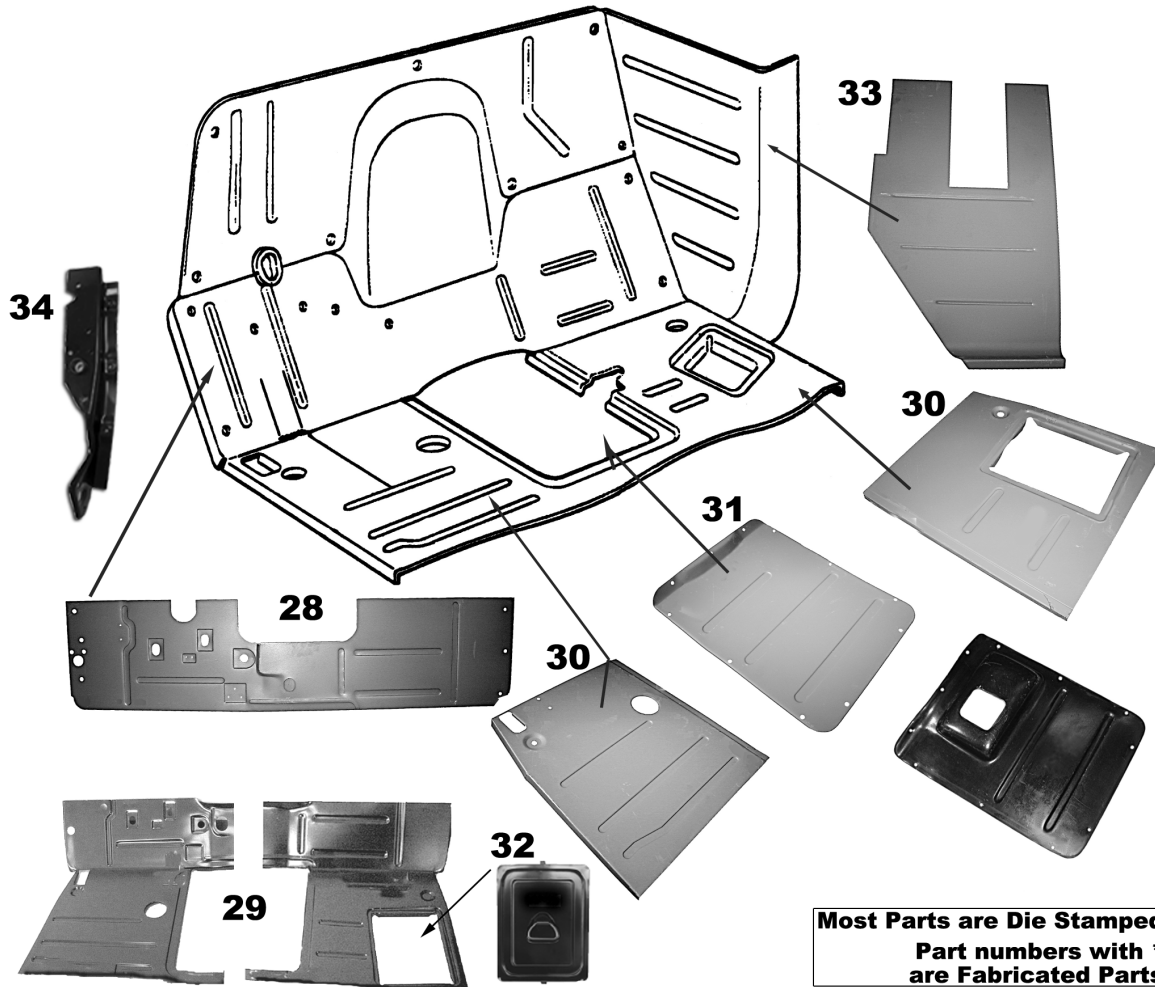
Note: For tank straps refer to section 120T.

Returns require a return authorization number, please call.

295T: 1947-54 Truck Body Parts



Format = Part No., Year, Description, original Chevrolet Part Book Group No., Price and Unit Measure.



28: Toe Board (Metal)			
3700191A	47-55	Floor to firewall.	(16.230-15) \$167.00 EA
29: Floor Panel (from seat forward)			
3701601LC	47-54	Complete with toe board left.	(16.545-2) \$116.50 EA
3701601RC	47-54	Complete with toe board right.	(16.545-2) \$116.50 EA
30: Floor Panel (from seat forward)			
3701601L	47-54	Left (die stamped).	(16.545-15) \$55.00 EA
3701601R	47-54	Right (die stamped).	(16.545-15) \$55.00 EA
31: Floor Insert Over Transmission			
3682939 *	48-54	Metal 3 speed.	(16.547-15) \$42.00 EA
3697607	47-54	Fiberglass 4 speed.	(16.547-15) \$48.00 EA
32: Battery Cover			
3683383	47-54	Mounts in floor.	(16.547-15) \$60.00 EA
33: Kick Panel-Metal Repair Panel			
3693495 *	47-50	Inner left.	(16.551-15) \$32.75 EA
3696023 *	51-54	Inner left.	(16.551-15) \$32.75 EA
3809358 *	47-54	Inner right.	(16.551-15) \$32.75 EA
34: Emergency Brake Bracket			
3687303	48-55	For foot operated pedal.	(04.648-15) \$45.00 EA

295T

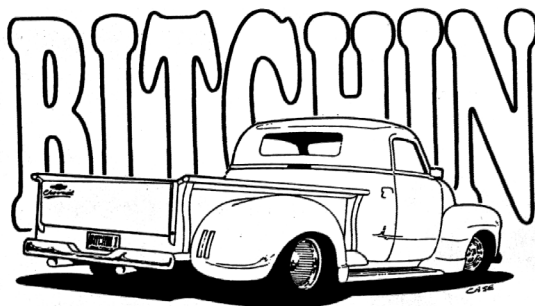
Providing part #'s speeds up your order, improves accuracy, and helps us maintain low prices.

See Illustration Index for core charge information and a list of abbreviations. For Body Model information, see 5T. 169

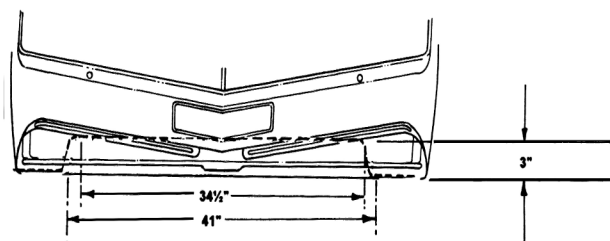


295T: BITCHIN' Sheetmetal Parts

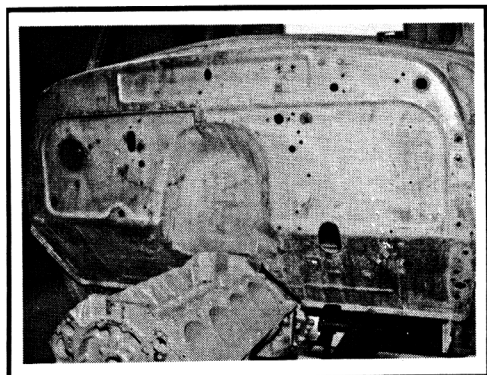
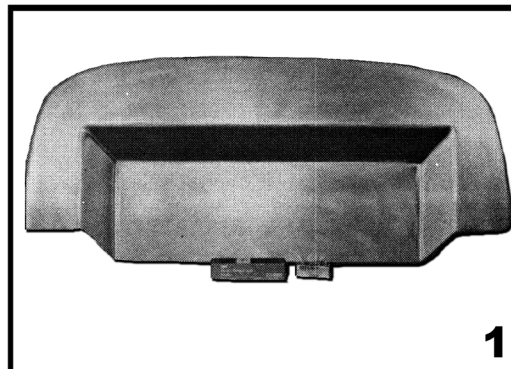
Format = Part No., Year, Description, original Chevrolet Part Book Group No., Price and Unit Measure.



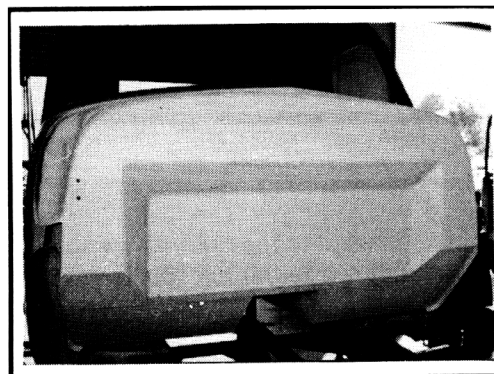
TRUCK STUFF



FIREWALL—PICKUP AND PANEL TRUCK



BEFORE YOU START....



AFTER YOU FINISH.....

1: Firewall (steel)

3693009S54 47-54

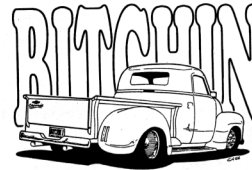
Recessed firewall for V8. Use with front floor kit #3686335b54 or stock floor(16.545-15) \$345.00 EA

Returns require a return authorization number, please call.

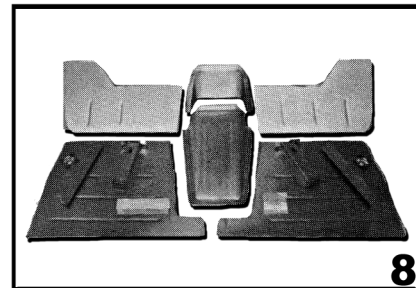
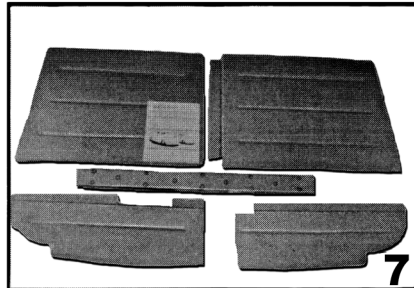
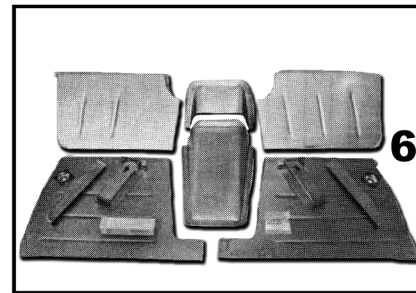
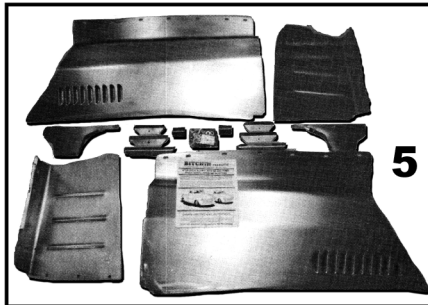
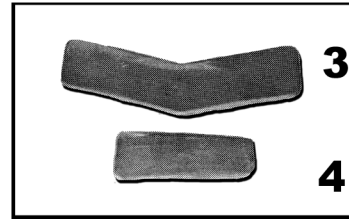
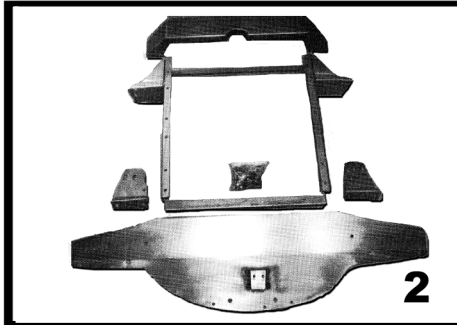


Format = Part No., Year, Description, original Chevrolet Part Book Group No., Price and Unit Measure.

MORE.....



TRUCK STUFF



2: Radiator Core Support

- 3684764 47-54
- 3684764B 47-54

For center fill radiator(-15) \$340.00 SET
 For radiator with side fill.....(16.545-15) \$340.00 EA

3: Cowl Vent Filler Panel

- 3683004A53 47-53
- 3683004B54 54

.....(16.545-15) \$24.00 EA
(16.545-15) \$24.00 EA

4: Driver's Side Vent Filler

- 3683001 47-54

.....(16.545-15) \$24.00 EA

5: Inner Fender Apron Kit

- 3686239 47-54

.....(16.545-15) \$360.00 SET

6: Floor Kit

- 3686335A54 47-54

Front floor with stock firewall.(16.545-15) \$290.00 SET

7: Floor Kit

- 3686336R54 47-54

Rear floor(16.545-15) \$168.00 SET

8: Floor Kit

- 3686335B54 47-54

Front floor panels with toe board. For use with "bitchin" firewall
 #3693009s54.(00.000-15) \$290.00 SET

295T

Providing part #'s speeds up your order, improves accuracy, and helps us maintain low prices.

See Illustration Index for core charge information and a list of abbreviations. For Body Model information, see 5T. 171



300T: Cab & Cab Mountings

Format = Part No., Year, Description, original Chevrolet Part Book Group No., Price and Unit Measure.

Cab Mount



366983..... ALL
1/8in. shims (1-3/4in. x
1-1/8in. with 1/2in. slot)
(6 pcs). (10.201-4)
\$2.75 SET



366982..... ALL
1/16in. shims (1-3/4in. x
1-1/8in. with 1/2in. slot)
(6 pcs). (09.023-4)
\$2.25 SET

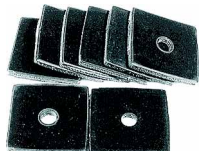


366985..... ALL
1/8in. shims (1-1/4in. x
1-1/8in. with 1/2in. slot)
(6 pcs). (09.023-4)
\$2.75 SET



366984..... ALL
1/16in. shims (1-1/4in. x
1-1/8in. with 1/2in. slot)
(6 pcs). (09.023-4)
\$3.25 SET

Body Mount Pads



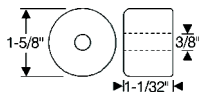
3685018A.....47-54
Panel or Suburban.
(09.023-3)
\$24.00 SET

Cab Mount Wood Blocks



476534B.....39-40
(09.009-15)
\$8.00 PR

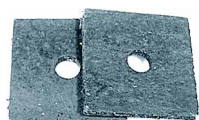
Cab Mount Pads



3654239B.....37-46
At #4 bolt. (09.015-15)
\$30.50 PR

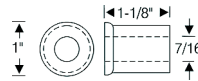


3654239.....39-46
w/ blocks & #4bolt pads
(1-7/8" dia. x 1-5/8"
thickness x 1/2" bolt
hole). (09.015-15)
\$32.00 SET



3701322.....47-54
Front (09.015-4)
\$4.50 SET

Cab Mount Rear



3660540 47-54
Rubber bushings (8
pcs). (09.023-4)
\$12.00 SET

Cab Mount Bolt Set



3654239A 37-40
(07.524-4)
\$16.00 SET

3654239A 41-46
(09.015-3)
\$16.00 SET



3701322C..... 47-54
Front (09.015-3)
\$4.25 SET

Cab Mount Body To Frame



3701322B..... 47-54
Pads & bolts. Front and
rear. (09.008-15)
\$25.00 SET

Odds & Ends

Please call for availability on all Odds & Ends parts; once part is sold, it may no longer be in stock.

5605.....34-37
Clutch Pressure plate 1-1/2T (-0)
\$95.00 EA

3725249.....54-56
Stud (w/ diaphragm spring clutch)
(12*000-0)
\$7.50 EA.

Returns require a return authorization number, please call.

310T: Firewalls, Firewall Pads & Firewall Grommets



Format = Part No., Year, Description, original Chevrolet Part Book Group No., Price and Unit Measure.

Street Rod Parts

Firewall Pad-Polyurethane w/ Insulation

3693009B.....47-54
Fits Bitchin firewall #3693009S54.
(16.802-15)
\$169.00 EA

Restoration Parts

Firewall Pad-Fiberglass w/ Insulation



3693007F 39-46
(16.802-15)
\$95.00 EA
3693009F 51-53
(16.802-15)
\$95.00 EA
3702869F 54
(16.802-15)
\$95.00 EA

Oversize shipping charges apply.
Please call for rate.

Firewall Pad-Fiber Board w/ Insulation

3687451 47-50
(16.802-15)
\$86.75 EA

Oversize shipping charges apply.
Please call for rates.

Metal Clips

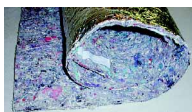


3692752 47-54
Firewall pad 1-3/16in.
long (3 pcs). (15.282-4)
\$10.50 SET

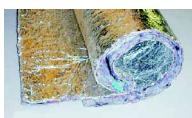


3692753 47-54
Firewall pad 1-3/16in.
long (3 pcs). (15.282-4)
\$9.00 SET

Insulation



3693008A ALL
Jute w/ foil on 1 side (4
ft wide) (15.282-15)
\$4.00 FT



3693008B ALL
Jute w/ foil on 2 sides (4
ft wide) (16.802-15)
\$5.50 FT

Firewall Grommets



3691292A 47-54
Grommet for 5/8in.
heater hose (thru
firewall). (16.802-3)
\$5.00 PR



3681096..... 33-46
Ignition armored coil
cable. (08.846-15)
\$5.50 EA



3653762A 39-53
Main wiring harness.
(09.775-3)
\$4.00 EA



3653762B 54-59
Main wiring harness.
(09.775-2)
\$4.00 EA



875520..... 39-53
Speedometer cable.
(09.775-4)
\$2.50 EA



874420A 39-53
Speedometer cable with
3 holes- use with
windshield washer.
(09.775-15)
\$4.75 EA

Firewall Grommets



3681071 32-46
Throttle, choke, oil,
temperature 3-7/8in.
long, 4 holes.
(09.775-15)
\$6.75 EA



3673139 36-54
Vacuum hose.
(09.775-4)
\$1.50 EA



3711896 51-53
Wiring harness 11/16in.
diameter. (09.775-15)
\$3.00 EA



3684771 47-49
4 holes. (09.775-3)
\$4.00 EA



3689044 50-52
4 holes. (09.775-2)
\$6.00 EA



3695170 53-59
4 holes. (09.775-3)
\$4.00 EA



357507 29-46
Steering column at floor
(exc COE). (09.775-15)
\$29.75 EA



3685928 47-54
Steering column with
metal core & sponge
seal #3682871 at
firewall (floor shift).
(06.758-15)
\$13.00 EA



3685928A 47-54
Steering column without
metal core at firewall
(floor shift). (06.758-15)
\$16.50 EA

310T

Providing part #'s speeds up your order, improves accuracy, and helps us maintain low prices.

See Illustration Index for core charge information and a list of abbreviations. For Body Model information, see 5T. 173



310T: Firewalls, Firewall Pads & Firewall Grommets

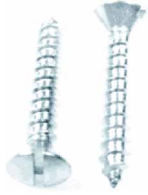
Format = Part No., Year, Description, original Chevrolet Part Book Group No., Price and Unit Measure.

Firewall Grommets



3687205.....48-54
Steering column with metal core & sponge seal #3687204 at firewall (column shift). (06.758 -15)
\$16.00 EA

Screws



3687205A.....47-54
Stainless steel for steering column grommet. (06.758-4)
\$2.25 EA

Steering Column and Pedal Seal-Felt



3657153.....41-46
Floor felt steer column brake, clutch. (06.758-15)
\$8.50 EA

Steering Coumn Seal-Sponge



3687204.....47-54
Steering column at firewall (column shift). (00.829-3)
\$5.50 EA



3682871.....47-54
Steering column at firewall (floor shift). (06.758-2)
\$4.00 EA

Rubber Plug



4805844.....49-52
Rubber for 3/4in. holes. (06.758-2)
\$1.75 EA



1951 Truck & Trailer—Ray Johnson, Oregon

Returns require a return authorization number, please call.



Format = Part No., Year, Description, original Chevrolet Part Book Group No., Price and Unit Measure.

Street Rod Parts

Sound Deadener/ Insulation Kit

Selecting a noise/ heat reduction product can be very confusing. We have made this an easier process by creating 3 different levels of kits: Ultimate, Acousti-Shield, & Economy.

Ultimate Noise Barrier Kit. This is a complete kit. Includes one vibration damping sheet, four acoustic sound floor barrier sheets & one gallon of sprayable sound deadener with complete instructions for all items in kit. The vibration damping sheet comes with adhesive backing and replaces plastic vapor barrier on inner door skin. 40% lighter than asphalt damping materials & can handle continuous temperatures to 250 degrees. The high performance acoustic floor barrier sheet is a composite consisting of a flexible, loaded vinyl massing barrier with a form decoupling layer designed to reduce road noise coming into the vehicle. It is ideal for applications over flooring, side panels & firewall. The sprayable sound deadener is a high performance air curing damping compound designed specifically for the interior & exterior side of body panels. Easy to apply, non-toxic & water based.

13209 ALL
Ultimate noise barrier kit (08.800-2)
\$620.00 EA

Ultimate Noise Barrier Kit with Heatshield

13209-1 ALL
Ultimate noise barrier kit with HEATSHIELD spray included (08.800-15)
\$725.00 EA

Sound Deadener/ Insulation Kit

ACOUSTI-SHIELD KIT INCLUDES: FULLY ILLUSTRATED INSTRUCTIONS FOR A PAINLESS, TWO-HOUR INSTALLATION. STAGE 1: PRE-SIZED SOUND DAMPER PADS. The first stage consists of pre-trimmed, self adhesive, Sound Damper Pads. Bonded to strategically located trouble spots on the floor pan and roof of the vehicle to control body panel vibration and noise. These spots are mapped and labeled in detailed instructions which are included in the kit. STAGE 2: PRE-TRIMMED HEAT ABSORBER/BARRIER PANELS, SPRAY ADHESIVES AND SEALING TAPE. The second stage uses a high-tech absorbing, barrier material bonded to the body panels. Will deaden sound and insulate the vehicle from radiant heat penetration. Each absorber panel is cut to the correct shape and contour and is mapped and labeled in the detailed instructions.



3693008C ALL
Foil tape for jute insulation (30 foot x 2in. roll) (15.492-15)
\$5.00 EA

12927 37-46
Fits 1937-46 Truck. (15.492-15)
\$384.00 EA

12928 47-54
Fits 1947-54 Truck. (16.802-15)
\$428.00 EA

15893 47-54
Fits 1947-54 Panel Truck. (15.492-15)
\$802.00 EA

15894 47-54
Fits 1947-54 SUBURBAN. (15.492-15)
\$769.00 EA

Economy Noise Barrier Kit

Economy Noise Barrier Kit includes: two thermal acoustic blankets, one gallon sprayable sound deadener, spray-on adhesive material & specialty seam tape plus complete instructions. Thermal acoustic blankets designed with foil top to reflect heat and cotton fiber layer to insulate & absorb moderate sound levels. The sprayable sound deadener is a high performance air curing, damping compound designed specifically for the interior & exterior side of body panels. Easy to apply non-toxic, water based. The spray on adhesive material is used to attach the insulator to the applied surface.

Basic Noise Barrier Kit

13211 ALL
Basic noise barrier kit (08.800-2)
\$212.00 EA
13211-1 ALL
Noise barrier kit with heat shield included (08.800-15)
\$317.00 EA

Sound Deadener-Thermal Protection



DEADENER ALL
The ultimate in noise reduction. Engineered specifically for the interior & exterior side of body panels. 200% decrease in noise & vibration than any .070in. asphalt material. Bonds to metal, fiberglass & wood. Easy to apply (spray gun, roller or brush), non-toxic & water based for easy clean up. Covers 30 sq. ft. (08.800-15)
\$78.00 GALLON

320T

Providing part #'s speeds up your order, improves accuracy, and helps us maintain low prices.

See Illustration Index for core charge information and a list of abbreviations. For Body Model information, see 5T. 175



320T: Floorboard Related, Sound Deadeners, Mats & Pedals

Format = Part No., Year, Description, original Chevrolet Part Book Group No., Price and Unit Measure.

Sound Deadener-Thermal Protection



HEATSHIELD ALL
Awesome heat reduction in a can!
Lightweight, pliable and bonds to virtually any material! Made up of air filled glass beads held in suspension by a high temp latex acrylic binder. Two 15 mil applications yield a thermal value of R-24. Insulate & prevent corrosion with one product. Easy to apply, non-toxic. (08.800-15)
\$100.00 GALLON



SPRAYGUN ALL
Spray gun. Siphon-feed spray gun for DEADENER & HEATSHIELD. (08.800-15)
\$100.00 EA

Body Deadener



121126C..... ALL
Hi-tech, 1/2 pound per square foot (3/16in. x 3 ft x 8 ft) (08.800-4)
\$21.00 FT



121126A..... ALL
Felt (original waffle pattern)-used on door skins, roofs, etc (3/32in. x 3 ft x 8 ft) (03.451-15)
\$69.50 EA



121126B..... ALL
(original waffle pattern)-used on door skins, roofs, etc (1/8in. x 3 ft x 8 ft) (15.492-15)
\$81.00 EA

Sound-Vibration Damping

VBDAMP-2ALL
Mineral loaded, lightweight polymer based damping sheets offering unparalleled damping along with the finest fit and finish. Adhesive backed for strong, permanent bonding to virtually any clean surface. Odorless vibration and noise damping. Ability to mold to irregular surfaces using a heat gun to create a vacuum molded look. Paintable and can be applied to wood, fiberglass, sheetmetals and plastic panels. Sheet size- 37in. X 54in. (covers 14 sq.ft.). (15.492-15)
\$70.00 EA

Sound-Vibration Damping

VBDAMP-2HD.....ALL
HEAVY DUTY mineral loaded, lightweight polymer based damping sheets. Sheet size- 37in. X 54in. (covers 14 sq. ft.). (08.800-15)
\$100.00 EA

Restoration Parts

Carpet With Pad

Yardage available to match 40in. wide and 80in. wide.



CUT PILE LOOP PILE

3716701C..... 37-46
Covers firewall to seat riser and side of seat riser. Specify Loop or Cut pile, Color and year of vehicle when ordering. (08.800-0)
\$125.00 EA



CUT PILE LOOP PILE

3698177C..... 47-53
Covers firewall to seat riser and side of seat riser. Specify Loop or Cut pile and Color when ordering. (16.800-0)
\$125.00 EA



CUT PILE LOOP PILE

3716701C..... 54-55
Covers firewall to cab back. Specify Loop or Cut pile and color when ordering. (16.800-15)
\$169.00 EA

Throw Mats

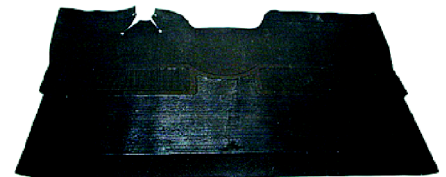


986765A ALL
Accessory. Rubber w/ black Bowtie (2 pcs) (16.800-3)
\$39.50 SET

Front Mat



3716701..... 37-46
Fits 37-40 w/ modification (16.800-15)
\$74.50 EA



3698177A 47-54
Reproduction (15.286-15)
\$118.00 EA

Jute Insulation Pad

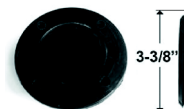


369818147-54
Floor mat (die cut). (16.800-15)
\$24.00 EA



3693008 ALL
Floor mat (3 ft x 6 ft) (16.800-15)
\$19.75 EA

Plug



59286536-54
Master cylinder inspection (in floor). (16.802-3)
\$10.25 EA

Returns require a return authorization number, please call.

320T: Floorboard Related, Sound Deadeners, Mats & Pedals



Format = Part No., Year, Description, original Chevrolet Part Book Group No., Price and Unit Measure.

Metal Plug



594289B..... **ALL**
Fits 1-1/2in. hole in floor over body mount bolts (2 pcs) (12.541-4)

\$6.50 SET

594289C..... **ALL**
Fits 3/4in. holes in floor (2 pcs) (09.008-3)

\$1.50 SET

594289D..... **ALL**
Fits 1/2in. holes in floor (2 pcs) (09.008-4)

\$1.25 SET

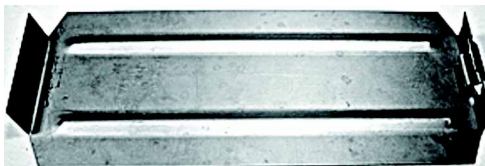
Battery Cover



354120 **29-38**
Inspection cover in floor. (09.008-3)

\$16.00 EA

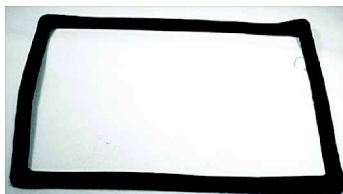
Battery



3652966 **39-46**
Inspection cover in floor. (16.547-3)

\$28.00 EA

Gasket



3683383A..... **47-54**
Battery inspection cover. (16.547-3)

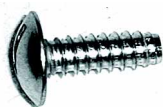
\$7.75 EA

Bolt Set



187694B **41-46**
For floor board (21 pcs).
(16.547-15)
\$4.75 SET

Screws



3652879..... **47-54**
For transmission cover
in floorboard. (16.542-4)
\$3.75 SET

Gasket



3697605..... **47-54**
For transmission cover
in floorboard. (12.559-2)
\$5.00 SET

Floorshift Seal



3653420..... **37-47**
Floor to transmission
3-speed. (16.547-15)
\$18.00 EA

Floor Shift Boot



3687200..... **37-54**
Floor to transmission
4-speed. (04.015-2)
\$5.00 EA

Floor Shift Boot



3651348A **ALL**
Replacement-3 speed
(uses #3654365t trim
ring). (04.015-4)
\$9.00 EA

Trim Ring



3654365T **ALL**
Stainless retains boot
#3651348A.
(04.015-15)
\$12.00 EA

Hand Brake Seal



3653418..... **40-54**
Sponge (under floor).
(04.044-2)
\$6.00 EA

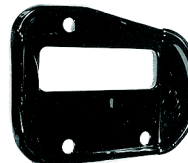
Emergency Pedal Seal



3694124A **48-54**
Emergency pedal brake
shaft. (04.612-2)
\$5.00 SET



3694124..... **48-54**
Under floor. (04.612-15)
\$7.00 EA



3694125..... **48-54**
Metal retainer.
(04.612-15)
\$6.75 EA



594988A **ALL**
Floor hand brake (not
original) uses trim plate
#595026 (04.615-4)
\$10.25 EA



595026..... **ALL**
Stainless-retains boot
#594988a (04.612-15)
\$8.00 EA

Starter Pedal



3654134..... **38-54**
Foot starter rubber
button. (04.613-3)
\$9.50 EA



397577 **29-54**
Foot starter rubber cap/
button (black).
(02.004-15)
\$10.00 EA



3716711 **38-54**
Rubber bellows.
(02.004-2)
\$7.00 EA



3654152 **37-54**
Return spring.
(02.014-2)
\$5.50 EA

320T

Providing part #'s speeds up your order, improves accuracy, and helps us maintain low prices.

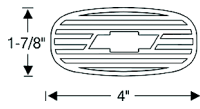
See Illustration Index for core charge information and a list of abbreviations. For Body Model information, see 5T. 177



320T: Floorboard Related, Sound Deadeners, Mats & Pedals

Format = Part No., Year, Description, original Chevrolet Part Book Group No., Price and Unit Measure.

Pedal Pad



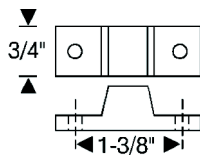
364022 **29-46**
Brake & clutch with bowtie. (02.029-15)

\$26.50 PR



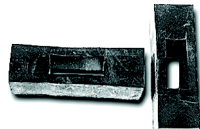
3683490 **47-59**
Brake, clutch & emergency. (04.630-3)
\$4.00 EA

Bumper



3681065 **37-46**
Clutch pedal (under floor). (04.630-15)

\$11.50 EA



3653388 **47-54**
Brake & clutch arms to floor (2 pcs). (09.108-4)
\$6.00 SET

Brake Pedal Return Spring



368244 **32-46**
(09.108-15)

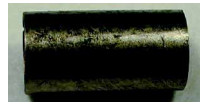
\$6.50 EA



3698665 **47-57**
Overall length 5-3/4in. (04.827-2)

\$5.00 EA

Bushings



3682074 **37-46**
Clutch & brake pedal shaft (13/16in. o.d. x 3/4in. i.d. x 1-25/64in. l) (04.827-15)

\$12.00 PR

3683016 **47**

Clutch & brake pedal shaft (13/16in. o.d. x 3/4in. i.d. x 1-25/64in. l) (04.827-15)

\$12.00 PR

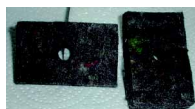
Pedal Seal



3657153 **41-46**
Floor felt steer column, brake, clutch. (04.626-15)

\$8.50 EA

Pedal Seal



594337 **47-51**
Floor felt brake & clutch pedal (2 pcs). (00.829-15)

\$4.00 SET



594337A **52-54**
Floor felt brake & clutch pedal (2 pcs). (00.829-15)

\$4.00 SET

Gas Pedal



3653533 **37-40**
2-1/4in. x 7-3/4in. (00.829-15)

\$17.00 EA



3681341A **42-46**
2-5/8in. x 7-3/4in. w/ pad. (03.451-15)

\$17.75 EA



3682873 **46-52**
2-7/8in. x 8-1/16in. (03.451-15)

\$14.00 EA



3701621 **53-57**
2-7/8in. x 8-1/16in. (03.451-15)

\$14.00 EA

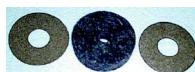
Gas Pedal Bushing & Seal



378431 **37**
Gas pedal rod (in floor). (15.492-4)

\$18.00 EA

Seal



3658395B **47-54**
(felt) gas pedal rod in floor. (03.469-15)

\$3.00 SET

Odds & Ends

Please call for availability on all Odds & Ends parts; once part is sold, it may no longer be in stock.

3659947U **39-46**
Brake & clutch pedal assembly used (-0)

\$40.00 EA

3672713U **42**
Gas pedal. Fits all COMM & UTIL. 2-5/8in.X7-7/8in. (Used) (04.625-0)

\$20.00 EA

597792 **ALL**
Starter pedal to starter link (3.451-0)

\$7.00 EA

Returns require a return authorization number, please call.

330T: Interior, Interior Screws, Dome Lights, Sunvisors, Seats, Headliner, Door Panels & Kick Panels



Format = Part No., Year, Description, original Chevrolet Part Book Group No., Price and Unit Measure.

Street Rod Parts

Headliner Conversion

For putting a headliner where there was none.

3808406C.....**37-54**
Panel or Suburban napped cotton hardware kit for installation is included. (2.033-15)
\$225.50 EA

Headliner-Moulded

These are ABS Plastic with a medium embossed leather grain texture. This material is easily formed with heat and duplicates the original look and texture exactly. ABS plastic is very tough, yet flexible, and does not show scratches or scuffs. It can be easily dyed with a flat vinyl plastic spray paint. Comes with Quality Heat Shield which should be glued in between roof and headliner, greatly reducing heat & noise inside the vehicle. All of our pttterns are based on out-of-vehicle originals. With few exceptions, truck headliners were black or brown when they came from the factory during the early years. ABS plastic can be easily dyed with a flat, vinyl plastic spray paint. The panels also can be covered with cloth or acoustic material.

Headliner-Molded ABS Plastic

593125P.....**37-38**
Fits trucks, exc Suburban. (16.742-15)
\$181.00 EA

3654634P.....**39-46**
Fits trucks, exc Suburban. (16.742-15)
\$169.00 EA

3676357P.....**47-53**
Fits trucks, exc Suburban. (16.742-15)
\$181.00 EA

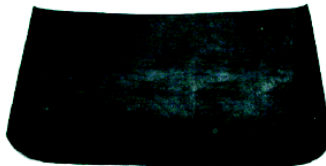
3700527P.....**54**
Fits trucks, exc Suburban. (16.742-15)
\$181.00 EA

Headliner Extension



467795.....**37-38**
Molded fiberglass, back of headliner around back glass to seat back. (16.563-15)
\$80.00 EA

Headliner-Moulded Fiberglass



3654634E.....**37-38**
1 piece. (17.274-15)
\$145.00 EA

3654634F.....**39-46**
1 piece. (16.742-15)
\$145.00 EA

3676537F.....**47-53**
1 piece. (16.742-15)
\$160.00 EA

3700527F.....**54**
1 piece. (16.742-15)
\$145.00 EA

Note: Oversize shipping charges apply. Please call for rates.

Sound-Vibration Damping

VBDAMP-2..... **ALL**
Mineral loaded, lightweight polymer based damping sheets offering unparalleled damping along with the finest fit and finish. Adhesive backed for strong, permanent bonding to virtually any clean surface. Odorless vibration and noise damping. Ability to mold to irregular surfaces using a heat gun to create a vacuum molded look. Paintable and can be applied to wood, fiberglass, sheetmetals and plastic panels. Sheet size- 37in. X 54in. (covers 14 sq.ft.). (16.742-15)
\$70.00 EA

Sound-Vibration Damping

VBDAMP-2HD..... **ALL**
HEAVY DUTY mineral loaded, lightweight polymer based damping sheets. Sheet size- 37in. X 54in. (covers 14 sq. ft.). (08.800-15)
\$100.00 EA

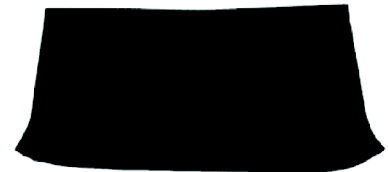


HEATSHIELD

Awesome heat reduction in a can! Lightweight, pliable and bonds to virtually any material! Made up of air filled glass beads held in suspension by a high temp latex acrylic binder. Two 15 mil applications yield a thermal value of R-24. Insulate & prevent corrosion with one product. Easy to apply, non-toxic. (08.800-15)

\$100.00 GALLON

Headliner-Die Cut



593125..... **37-38**
1pc black, brown or gray (specify color when ordering). (16.494-15)
\$44.00 EA



3801123..... **39-41**
1pc black, brown or gray (specify color when ordering). (16.742-0)
\$44.00 EA

330T

Providing part #'s speeds up your order, improves accuracy, and helps us maintain low prices.

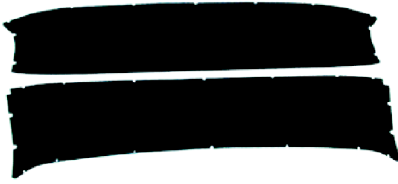
See Illustration Index for core charge information and a list of abbreviations. For Body Model information, see 5T. 179



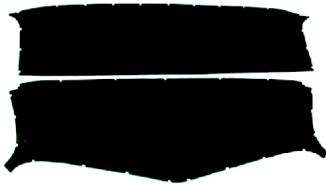
330T: Interior, Interior Screws, Dome Lights, Sunvisors, Seats, Headliner, Door Panels & Kick Panels

Format = Part No., Year, Description, original Chevrolet Part Book Group No., Price and Unit Measure.

Headliner-Die Cut



3654634 **42-46**
2pc black, brown or gray (specify color when ordering). (16.742-15)
\$30.00 SET



3694283 **47-49**
Black, brown or gray (specify color when ordering). (16.742-15)
\$30.00 SET



3676357 **50-53**
2pc black, brown or gray (specify color when ordering). (16.742-15)
\$30.00 SET

3700527 **54**
Black, brown or gray (2 piece) (specify color when ordering). (16.742-15)
\$30.00 SET

Headliner Bow

3807558 **50-54**
Center (52in. long). (16.742-15)
\$25.00 EA

Headliner Washers



3654636 **34-41**
(rubber) perfect repro. (16.745-15)
\$3.25 SET

J-nut Retainer



0184001 **37-46**
Front of headliner (5 pcs). (16.747-4)
\$3.75 SET

Screw Set



477366 **41-46**
Headliner 8 x 32 x 5/16in. clutch head (22 pcs). (16.742-4)
\$9.00 SET



3654597B **47-54**
Headliner. (16.742-3)
\$4.25 SET



3694284B **47-54**
Headliner, door panel, window & windshield garnish mouldings. (16.290-3)
\$13.50 KIT



3684481A **47-54**
Windshield garnish moulding (14 pcs). (16.290-4)
\$3.50 SET



3684481B **47-54**
Window garnish mouldings, 2 doors. (16.290-3)
\$5.25 SET



3684161A **47-53**
Door panel, cardboard, does both doors (12 pcs). (16.290-4)
\$3.25 SET

Interior Screws



3654597C **37-50**
8 x 32 x 1/2in. clutch head (10 pcs). (16.290-4)
\$3.00 SET



3654597A **37-50**
8 x 32 x 1/2in. clutch head (100 pcs). (16.170-4)
\$20.50 SET

Clutch Head Driver W/ Bits

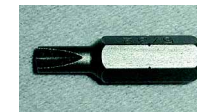


DRIVER **ALL**
Magnetic driver w/ 5 bits (1/8in., 5/32in., 3/16in., 1/4in., 5/16in.) with Chevs imprint. (16.170-15)
\$22.25 SET

Clutch Head Bits



3685598
1/8in. (1/4in. drive) (08.821-3)
\$4.00 EA



3685592
5/32in. (1/4in. drive) (08.821-4)
\$4.00 EA



3685594
3/16in. (1/4in. drive) (08.821-3)
\$4.00 EA



3685593
1/4in. (1/4in. drive) (08.821-3)
\$4.00 EA



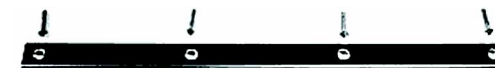
3685595
5/16in. (1/4in. drive) (08.821-2)
\$6.00 EA

Clutch Bit Holder



3685596
For your 1/4in. drive ratchet. Holds clutch head bits. (08.821-2)
\$6.00 EA

Windshield Divider Moulding



3684697 **47-53**
Stainless windshield division trim. Interior. (08.821-15)
\$54.50 EA

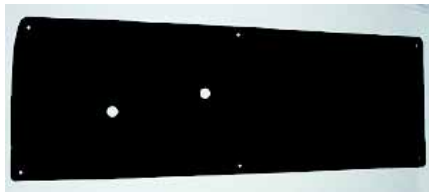
Returns require a return authorization number, please call.

330T: Interior, Interior Screws, Dome Lights, Sunvisors, Seats, Headliner, Door Panels & Kick Panels



Format = Part No., Year, Description, original Chevrolet Part Book Group No., Price and Unit Measure.

Door Panels



3700543A.....47-54
Original leather grain brown, black or maroon (specify color). (16.018-0)
\$16.00 L&R

3700543.....47-54
Black, brown or gray, specify color when ordering. (16.165-0)
\$12.00 L&R

Retainer Button



3707152.....54
Door panel cardboard, use 12. (16.165-4)
\$1.00 EA

Kick Panels



474791.....36-38
Inner, brown, black or gray, specify color when ordering. (16.165-2)
\$16.00 L&R



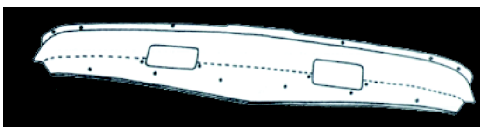
609526.....39-46
Inner, brown, black or gray, specify color when ordering. (16.700-3)
\$16.00 L&R



609527.....47-54
Inner, black, brown or gray, not original. Specify color when ordering. (16.700-2)
\$16.00 L&R

Restoration Parts

Header Panel



593369.....36-38
Mounts above windshield (fiberglass). (08.800-15)
\$80.00 EA

598772.....39-46
Mounts above windshield (fiberglass). (16.562-15)
\$93.75 EA

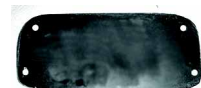
Cover-Wiper Motor Access Hole



593351L.....36-38
Left (fiberglass). (16.563-15)
\$19.00 EA



593352R.....36-38
Right (fiberglass). (16.563-15)
\$19.00 EA



593353.....36-38
Blank (right hand side w/out cover-wiper) (fiberglass). (16.563-4)
\$15.00 EA



598811L.....39-46
Left (fiberglass). (16.563-15)
\$19.00 EA



598813R.....39-46
Right (fiberglass). (16.563-15)
\$19.00 EA



598814.....39-46
Blank (fiberglass). (16.563-15)
\$15.00 EA

Seat Belts



2002..... ALL
2-point retractable lap only belts available in black, burgundy, gray or tan (specify color when ordering). Comes with standard pushbutton release. (-3)
\$55.00 EA



1001..... ALL
Lap belts available in black, burgundy, gray or tan (specify color when ordering). Comes with standard pushbutton release (14.875-3)
\$25.00 EA



13245..... ALL
Hardware kit for one complete seat belt. Includes 2 of each: bolts, washers, lock washers and nuts. (14.875-2)
\$3.75 SET



SBELTABK..... ALL
Black. Aircraft style w/ chrome buckle. Length 74 inches. (14.875-15)
\$20.00 EA



SBELTABL..... ALL
Dark Blue. Aircraft style w/ chrome buckle. Length 74 inches. (14.875-15)
\$20.00 EA



SBELTABR..... ALL
Brown. Aircraft style w/ chrome buckle. Length 74 inches. (14.875-15)
\$20.00 EA



SBELTAGY..... ALL
Grey. Aircraft style w/ chrome buckle. Length 74 inches. (14.875-15)
\$20.00 EA



SBELTAMA..... ALL
Maroon. Aircraft style w/ chrome buckle. Length 74 inches. (14.875-15)
\$20.00 EA

330T

Providing part #'s speeds up your order, improves accuracy, and helps us maintain low prices.

See Illustration Index for core charge information and a list of abbreviations. For Body Model information, see 5T. 181



330T: Interior, Interior Screws, Dome Lights, Sunvisors, Seats, Headliner, Door Panels & Kick Panels

Format = Part No., Year, Description, original Chevrolet Part Book Group No., Price and Unit Measure.

Seat Belts



SBELTARW..... ALL
Red wine. Aircraft style w/ chrome buckle. Length 74 inches. (14.875-15)
\$20.00 EA



SBELTARD ALL
Red. Aircraft style w/ chrome buckle. Length 74 inches. (14.875-15)
\$20.00 EA



SBELTATA ALL
Tan. Aircraft style w/ chrome buckle. Length 74 inches. (14.875-15)
\$20.00 EA

SBHP ALL
Reinforcing plates. Reduces chance of floor damage on high belt loads. Kit for 1 belt. (14.875-15)
\$15.00 EA

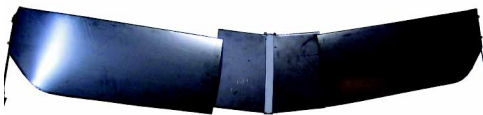
SBHPA ALL
Angled mounts for flat floor applications. Use with part #SBHP to complete your seat belt installation. Kit for 1 belt. (14.875-15)
\$10.00 SET

Sunvisor-Exterior



986877F.....47-53
Aluminum, Fulton repro w/ mounting hardware & instructions. (37-52 car). Adjustable. (14.875-15)
\$490.00 EA

986877FSD..... 47-53
Steel, Fulton reproduction with mounting hardware & instructions. Adjustable. (10.201-15)
\$500.00 EA



986877 47-53
Accessory. Exterior Sunvisor. (16.544-15)
\$225.50 EA

Sunvisor



3685637.....47-53
Interior visor with bracket, screws & template. Left side, brown. (10.201-15)
\$45.00 EA

986155.....47-53
Interior visor with bracket, screws & template. Right side, black, brown & gray (specify color). (16.070-15)
\$45.00 EA

3703645A54
Interior visor with bracket, screws & template. Left side, brown. (16.070-15)
\$45.00 EA

3703645.....54
Interior visor with bracket, screws & template. Left side, black. (16.070-15)
\$45.00 EA

3703645.....54
Interior visor with bracket, screws & template. Left side, black, brown & gray (specify color). (16.070-15)
\$45.00 EA

3703645B54
Interior visor with bracket, screws & template. Left side, gray. (16.070-15)
\$45.00 EA

986773.....54
Interior visor with bracket, screws & template. Right side, black, brown & gray (specify color). (16.070-15)
\$45.00 EA



3685637B47-59
Interior visor. Brown. (16.070-15)
\$30.00 EA

3685637C47-59
Interior visor. Black. (16.070-15)
\$30.00 EA

Sunvisor

3685637D 47-59
Interior visor. Gray. (16.070-15)
\$30.00 EA



3685637L..... 47-53
Interior visor support. Left side with screws & template. (16.070-15)
\$24.00 EA

3703645L..... 54
Interior visor support. Left side with screws & template. (16.070-15)
\$20.00 EA

986773R 54
Interior visor support. Right with screws & template. (16.070-15)
\$20.00 EA

Dome Light



407397537-46
Lens with round rim. Fits panel & Suburban. (16.070-15)
\$27.50 EA



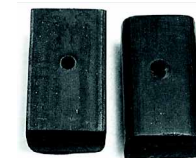
593708047-54
Painted. Dome light assembly with lens & bulb (6 or 12 volt). (16.494-15)
\$50.00 EA

5937080C 47-54
Chrome-with lens & bulb (6 or 12 volt). (16.494-15)
\$50.00 EA



5937080A.....47-54
Dome light lens gasket. (16.494-2)
\$1.25 EA

Seat Bumpers



368121636-46
(16.700-15)
\$3.50 PR

Returns require a return authorization number, please call.

330T: Interior, Interior Screws, Dome Lights, Sunvisors, Seats, Headliner, Door Panels & Kick Panels



Format = Part No., Year, Description, original Chevrolet Part Book Group No., Price and Unit Measure.

Seat Frame



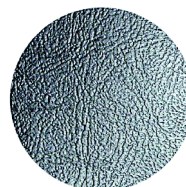
367314B 47-54
Rear bumper & screw set (4 piece). (16.772-15)
\$7.00 PR

Grommet



3695783 51-54
(anti-rattle) seat adjust rod. (16.682-15)
\$2.25 EA

Seat Cover



593345 37
W/ split seat bottom (brown). (16.682-15)
\$170.50 EA



593345A 37
W/ split seat bottom (black). (16.715-15)
\$170.50 EA

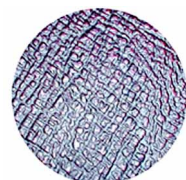


3808199 37-46
Black (16.715-0)
\$145.00 EA



3808200 47-49
Matches repro door panels-black or brown(specify color when ordering). (16.715-15)
\$150.00 EA

3808200C.....47-49
Matches Repro Door Panels-maroon. (16.715-15)
\$188.00 EA

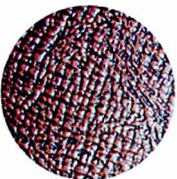


3808201 47-49
Original-maroon (specify year when ordering). (20.715-15)
\$150.00 EA

Seat Cover



3808205..... 50-54
Original-black, brown or tan (specify color when ordering). (16.715-0)
\$131.00 EA



3808204..... 54
Original (spanish grain brown). (16.715-15)
\$142.25 EA

French Stitching Option

380820354
For above GMC covers. Add this price to cost of seat cover above. Special order. (16.715-15)
\$25.00 EA

Upholstery Batting

4092635B.....37-54
Cotton material placed in between upholstery and burlap. 24in. wide. (16.175-3)
\$2.00 FT

Odds & Ends

3684697U47-53
Moulding inside windshield division (Used) (14.799-0)
\$150.00 EA

3806652U39-46
Seat bracket (Used) (16.018-0)
\$10.00 SET

469853U46
Seat brackets (Used) (16.680-0)
\$10.00 EA

330T

Providing part #'s speeds up your order, improves accuracy, and helps us maintain low prices.

See Illustration Index for core charge information and a list of abbreviations. For Body Model information, see 5T. 183

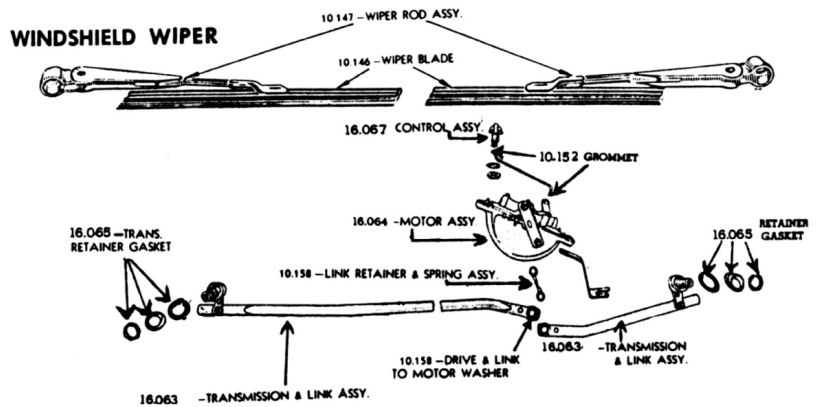


340T: Traffic Viewers, Dash Knobs, Cables & Cigarette Lighter

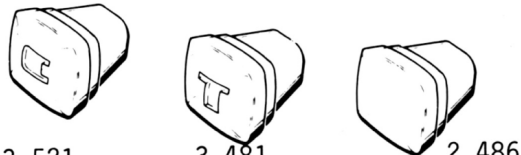
Format = Part No., Year, Description, original Chevrolet Part Book Group No., Price and Unit Measure.



Windshield Wiper—See Section 370T



1936-9 Trk Choke, Throttle, Lights Black



3.521 3.481 2.486
1940-46 Trk Choke, Throttle, Lights Rose Tan

WINDOW RISER KNOBS

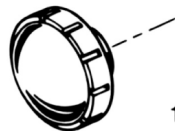
1939 Trk Window Knob Black

1940-46 Trk Window Rose Tan

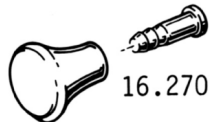
1940-46 Trk Ash Tray Rose Tan



1947-53 Trk Vent Knob Maroon 1954 Trk Black



9.650
1954 Trk Windshield Wiper Black GMC Grey

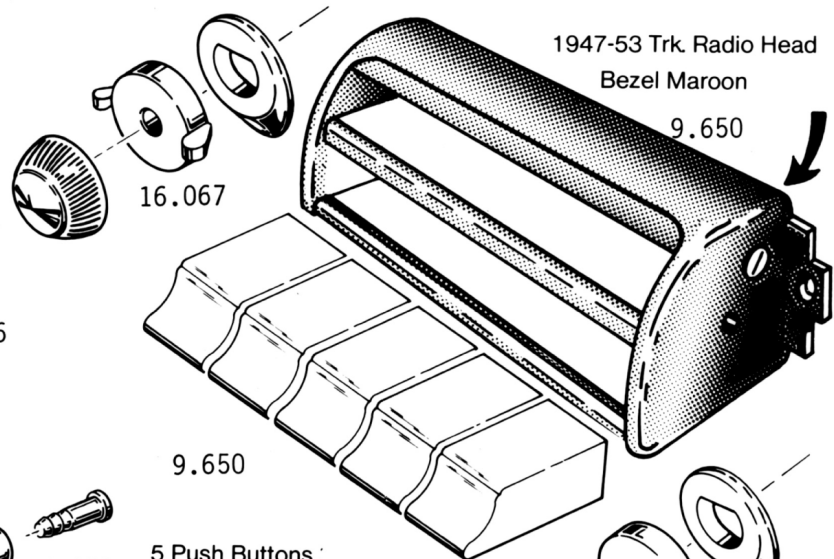


16.270



16.120

Radio Knobs—See Section 360T



1947-53 Trk Radio Head Bezel Maroon

9.650

16.067

9.650

5 Push Buttons
1947-53 Trk 4 Piece Set

9.650

1947-53 Trk Radio Escutcheon Maroon

2.906

1954-9 P.U. Turnsignal Knob Black

9.650

1954 Trk Radio Black GMC Grey

Returns require a return authorization number, please call.

340T: Traffic Viewers, Dash Knobs, Cables & Cigarette Lighter



Format = Part No., Year, Description, original Chevrolet Part Book Group No., Price and Unit Measure.

Traffic Light Viewer

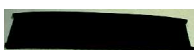


986550 50-56
Superb reproduction.
(10.201-15)
\$36.00 EA

Steering Column Insulator



3681057A 34-46
Steering column to
dash, brown exc COE.
(10.201-15)
\$11.50 EA



598145 34-46
Steering column to
dash, black exc COE.
(06.758-15)
\$1.75 EA



3685524 47-53
Steering column to
dash, black exc COE.
(06.758-15)
\$2.50 EA

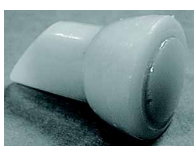


3700190 54
Steering column to
dash. (06.758-15)
\$3.00 EA

Cowl Vent Knob



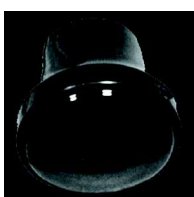
985261 37-38
Ivory accessory (original
38) (06.758-15)
\$16.00 EA



985603 40-46
Ivory accessory
(09.691-15)
\$16.00 EA



3656663A 40-46
As original, brown.
(09.691-15)
\$8.00 EA



3682916A 47-53
Side or top vent,
maroon. (16.130-15)
\$9.00 EA

Cowl Vent Knob



3131111..... 54
Black (16.130-15)
\$9.00 EA

Wiper Knob



3685141..... 47-49
Chrome (16.130-15)
\$7.00 EA



3699117..... 50-53
Maroon (16.067-15)
\$7.00 EA



3703853..... 54
Black (16.067-15)
\$9.00 EA

Emergency Brake Release



3690404..... 48-51
Handle (chrome).
(16.067-15)
\$13.32 EA



1990717..... 52-53
Knob (maroon).
(04.592-15)
\$9.00 EA



1990717A 54
Knob (black).
(04.600-15)
\$10.00 EA

Grommet-Emergency Brake Release



3696521..... 51-54
(04.600-15)
\$1.25 EA

Knob-Window or Windshield



598910A 39
Window or windshield
crank. Black.
(09.775-15)
\$9.00 EA



3654632B 40-46
Window or windshield
crank. Rose tan.
(16.270-15)
\$9.00 EA

Windshield Crank



598909 39
W/ black knob
(16.270-15)
\$34.00 EA



3654631A 40-46
W/ brown knob
(16.050-15)
\$34.00 EA



598986 37-38
Grommet, windshield
crank to dash.
(16.050-15)
\$2.75 EA

Turn Signal Knob

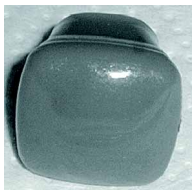


5939511A 54-59
(16.053-15)
\$9.00 EA

Headlight Knob



1861895 36-39
Black (02.906-15)
\$9.00 EA



599352 40-46
Rose tan (02.486-15)
\$9.00 EA

340T

Providing part #'s speeds up your order, improves accuracy, and helps us maintain low prices.

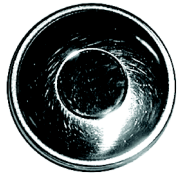
See Illustration Index for core charge information and a list of abbreviations. For Body Model information, see 5T. 185



340T: Traffic Viewers, Dash Knobs, Cables & Cigarette Lighter

Format = Part No., Year, Description, original Chevrolet Part Book Group No., Price and Unit Measure.

Headlight Knob



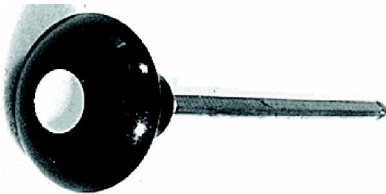
1990661A.....47-53
(02.486-15)
\$9.00 EA



1990661 47-53
With shaft (02.486-15)
\$10.00 EA



1990734.....54
Exc forward control.
Black. (02.486 -2)
\$9.00 EA



3653818K..... 54
With shaft. Black. (02.486-2)
\$13.75 EA

Choke Knob



476495A.....36-39
Black (02.485-15)
\$9.00 EA



3657151A.....40-46
Rose tan (03.521-15)
\$9.00 EA



1992564A.....47-53
Chrome over maroon.
(03.521-15)
\$9.00 EA

Choke Knob



199637A..... 54
Exc Double Duty, COE,
FFC. Black. (03.521-15)
\$9.00 EA

Choke Cable Assembly



476495 36-39
W/ knob (03.521-15)
\$32.00 EA



3657151 40-46
W/ knob (03.521-15)
\$32.00 EA



1992564 47-53
W/ knob (03.521-2)
\$20.00 EA



199637 54
W/ knob-exc Double
Duty, COE, FFC.
(03.521-15)
\$20.00 EA

Throttle Knob



476751A..... 36-39
Black (03.521-15)
\$9.00 EA



3654274A..... 40-46
Rose tan (3.481 -15)
\$9.00 EA



1991581A..... 47-53
Chrome over maroon
(03.481-15)
\$9.00 EA

Throttle Knob



1992599A.....54
Black exc Double Duty,
COE, FFC. (03.481-15)
\$9.00 EA

Throttle Cable Assembly



47675136-39
W/ knob (03.481-15)
\$32.00 EA



365427440-46
W/ knob (03.481-15)
\$32.00 EA



199158147-53
W/ knob (03.481-2)
\$20.00 EA



199259954
W/ knob exc Double
Duty, COE, FFC.
(03.481-15)
\$20.00 EA

Shift Knob



37499329-47
3-speed floor shift push-
on. Black. (03.481-15)
\$7.75 EA



374993B.....29-54
4-speed screw-on.
Black. (04.009-15)
\$7.50 EA

Column Shift Knob



368689847-53
Maroon. (04.009-15)
\$6.00 EA

Returns require a return authorization number, please call.

340T: Traffic Viewers, Dash Knobs, Cables & Cigarette Lighter



Format = Part No., Year, Description, original Chevrolet Part Book Group No., Price and Unit Measure.

Column Shift Knob



3698233 54-59
Black (04.009-15)
\$6.00 EA

Wire Stop



3655561ALL
Adjustable end for hood, choke, throttle cables, etc. (04.009-3)
\$1.00 EA

Ash Tray Knob



3658055 40-46
Rose tan (08.077-15)
\$9.00 EA



3685694 47-53
Chrome (16.120-15)
\$9.00 EA

Cigarette Lighter



986050J.....ALL
6v w/ socket & element, no knob. (16.122-15)
\$32.00 EA



986050L..... 47-53
6v w/ socket & knob maroon w/ chrome ring (original 51-53). (09.709-15)
\$20.00 EA



986050K 47-53
12v w/ socket & knob maroon w/ chrome ring (original 51-53). (09.709-15)
\$20.00 EA



3707720A 54
6v w/ socket & knob. Black knob w/ white center. (09.709-15)
\$15.00 EA

Cigarette Lighter



3707720B 54
12v w/ socket & knob. Black knob w/ white center. (09.709-15)
\$15.00 EA

Lighter Element



986050A 42-53
6v, fits original Casco (NOS). (09.709-4)
\$20.00 EA

Odds & Ends

375743U..... 41-46
Choke and throttle bracket (Used) (09.709-0)
\$15.00 EA

3847003U..... 41-46
Firewall grommet bracket (Used) (3.521-0)
\$10.00 EA



1952 1/2 Ton—Jack Peerman, Oregon

340T

Providing part #'s speeds up your order, improves accuracy, and helps us maintain low prices.

See Illustration Index for core charge information and a list of abbreviations. For Body Model information, see 5T. 187



345T: Tissue Dispenser, Mirrors & Mirror Arms

Format = Part No., Year, Description, original Chevrolet Part Book Group No., Price and Unit Measure.

Tissue Dispenser



986672 **53-55**
Superb repro, w/ bowtie. (10.185-15)
\$94.50 EA

Mirror-Rear View (Day/ Night)



985994 **37-50**
Original 42-50 accessory. (08.891-15)
\$60.00 EA



986632 **51-52**
Original accessory. (10.185-2)
\$75.00 EA



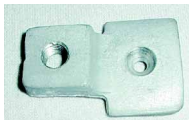
986948 **53-59**
Original accessory. (10.185-2)
\$80.00 EA

Mirror-Rear View (Interior)



4584708 **53-59**
Stainless (10.185-15)
\$24.00 EA

Mirror Bracket-Interior



986875 **47-53**
(10.185-15)
\$9.50 EA



986875A **47-53**
Stainless (16.069-15)
\$6.00 EA

Mirror Bracket-Interior



986898 **54**
(16.069-15)
\$17.50 EA



986898A **54**
Chrome (16.069-15)
\$20.00 EA

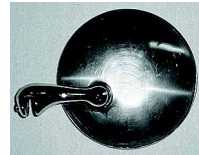
Mirror-Peep



985231A **ALL**
Original era. 3in. round.
Fits left or right.
(16.069-2)
\$20.00 EA



985231B **ALL**
Original era. 4in. round.
Fits left or right.
(10.185-2)
\$22.00 EA



985235A **37-54**
Original 40-50, less GM
script, left. (10.185-2)
\$22.00 EA

Mirror Head



3696632 **31-54**
Outside 5in. (as
original). (10.185-3)
\$14.00 EA



3696632B **31-54**
Outside 5in. (chrome).
(16.068-3)
\$16.00 EA



3696632RB **47-72**
Outside rectangle.
black. (16.068-2)
\$16.00 EA



3696632R **47-72**
Exterior, rectangular.
Stainless. Fits right or
left side. (16.068-2)
\$16.00 EA

Mirror Arm-Exterior



592145 **36-38**
Left (16.068-15)
\$19.00 EA



592146 **36-38**
Right (16.069-15)
\$19.00 EA



599013L **39-46**
Left (16.069-15)
\$18.00 EA



599014R **39-46**
Right (16.069-15)
\$18.00 EA



3684883 **47-50**
Left (16.069-15)
\$15.00 EA

Returns require a return authorization number, please call.

345T: Tissue Dispenser, Mirrors & Mirror Arms



Format = Part No., Year, Description, original Chevrolet Part Book Group No., Price and Unit Measure.

Mirror Arm-Exterior



369605947-54
Left, original 51-54. (16.068-15)
\$19.00 EA



3696059C.....47-54
Left, chrome, original 51-54. (16.068-15)
\$30.00 EA



369536847-54
Right (16.068-15)
\$19.00 EA



3695368C.....47-54
Right, chrome (16.068-15)
\$30.00 EA

Screws-Mirror Arm



604714A 47-54
Mirror arm, outside,
stainless steel (2 pcs).
(16.068-4)
\$2.50 SET

Gasket-Mirror Arm



597606 47-54
Mirror arm to cowl,
outside. (16.069-15)
\$1.00 EA

Pad-Mirror Arm



597606A 47-54
Mirror arm (rubber w/
beaded edge).
(16.069-4)
\$2.50 EA

Odds & Ends

Please call for availability on all Odds & Ends parts; once part is sold, it may no longer be in stock.

9852364U ALL
4in. peep Mirror. GM Script (-0)
\$40.00 EA

3696059U47-54
Exterior mirror arm. Left, original for 51-54.
Need screw & gasket (Used). (29-0)
\$15.00 EA

1548137-54
Mirror w/ arm (not original) (16.068-0)
\$6.00 EA

985231U ALL
Peep Mirror- 3in. round head (Used)
(29^000-0)
\$10.00 EA

516505U ALL
Rear view mirror. Painted back (Used).
(29-0)
\$40.00 EA

985268N37-48
Vanity Mirror- (NOS) (Unlit) (10.185-0)
\$75.00 EA

345T

Providing part #'s speeds up your order, improves accuracy, and helps us maintain low prices.

See Illustration Index for core charge information and a list of abbreviations. For Body Model information, see 5T. 189



350T: Gauges, Dash Panels, Instrument Glass, Dash Parts, Glove Boxes & Voltage Reducers

Format = Part No., Year, Description, original Chevrolet Part Book Group No., Price and Unit Measure.

Classic Instruments Gauges

**2 Gauges
in 1**



Hot Rod Series White Hot Series Vintage Series Silver Series

\$576.00

SpeedTach Ultra™ 5" combo gauges shown above, also available with matching auxiliary gauge sets

Chevs of the 40's is proud to offer quality gauges from Classic Instruments American made, assembled by hand and used by today's top car builders



The reason you build a custom vehicle is to have it your way. No other instrument company can offer you the range of choices in "standard" lines of gauges. With Classic you can select from many separate face designs, flat or curved glass, different pointer designs and different metal finishes on the bezel rings. Why settle for plain when you can have gauges that compliment your vehicle?

Series Available:

- * All American - Swirl Cut Silver Center Face
- * Vintage (tan face) * Silver
- * Hot Rod (black face) * Classic White * White Hot



\$477.00

All American Series shown above
3-3/8" Speedo & 3-3/8" Quad



\$486.00

Hot Rod Series shown above
5 gauge set - 3-3/8" Speedo
2-1/8" Fuel, Temp, Volts & Oil



\$119.00

Hot Rod Series Tach
shown above
3-3/8" Speedo



Classic White Speedo
w/ low step bezel above



Classic White Quad
w/ radial bezel above



\$536.00

All American Series shown above
5 gauge set - 3-3/8" Speedo
2-1/8" Fuel, Temp, Volts & Oil

Billet Aluminum Dash Panels

Land your new gauges in one of our billet aluminum dash panels. These panels will house Classic Instrument gauges listed above and other gauge brands including some stock gauges



\$170.00

#ALUMDASH-47-53
47-53 Truck 5-hole shown above
Speedo 3-3/8" & Quad 2-1/8"



\$150.00

ALUMDASHQ-40-46
40-46 Truck 2-hole shown above



\$150.00

ALUMDASH-40-46
40-46 Truck 5-hole shown above

Highly Polished, Precision CNC machined gauge panels from 6061 T6 Billet Aluminum
Some stock, Classic Instruments and Dolphin gauges will fit (instrument bezels-not included)



\$130.00

ALUMDASH5-47-53
47-53 Truck 5" shown above



\$130.00

ALUMDASHQ-54
54 Truck 3-3/8" shown above
(gauges not included)

**Visit our web site or call for additional applications & styles.*

Returns require a return authorization number, please call.

350T: Gauges, Dash Panels, Instrument Glass, Dash Parts, Glove Boxes & Voltage Reducers



Format = Part No., Year, Description, original Chevrolet Part Book Group No., Price and Unit Measure.

Street Rod Parts

Gauge Cluster

858983R8.....36-39
Rebuilt fits V8 (\$150 core). (09.748-15)

\$425.00 EA

1564308R8.....40-46
Rebuilt fits V8 (\$50 core). (09.748-15)

\$425.00 EA

1500924R8.....47-54
Rebuilt fits V8 (\$100 core). (09.748-15)

\$425.00 EA

1500924C12V47-49
New set. 12 volt, 8 cylinder. Oil (0-60lbs),

Temp (0-220 deg). Red needles. (09.748-15)

\$350.00 EA

1500924C12V50-53
New set. 12 volt, 8 cylinder. Oil (0-60lbs),

Temp (0-220 deg). Red needles. (09.748-15)

\$350.00 EA

Gauges

1511898M47-48
Temp gauge. Red needle, fits 8 CYL

engine only (increased line length), exc D/D & COE. (01.148-15)

\$55.00 EA

1512701M49-53
Temp gauge. White needle, fits 8 CYL

engine only (increased line length), exc D/D & COE. (01.148-15)

\$55.00 EA

1516973M..... 47-48

Fuel Gauge. 12 Volt. Red needle. Fits all

Comm & Util. (03.108-15)

\$55.00 EA

1517169M..... 49-53

Fuel Gauge. 12 Volt. White needle. Fits all

Comm & Util. (03.108-15)

\$55.00 EA



Instrument Glass



1565308A.....40-46

V8 markings w/ temp to 220 degrees & oil pressure at 60 psi (Fits 1940 Car, and 1940-46 Truck) (10.185-2)

\$26.75 EA

Voltage Reducer

1506373AALL

12v to 6v. Up to 4 amp draw affects voltage (01.064-3)

\$8.25 EA



1119004.....ALL

12v conversion. Best for fuel gauge. Hi-Tech w/ constant volts (02.500-15)

\$18.00 EA



1119005.....ALL

12v to 6v voltage reducer to operate heater, radio & gauges. Hi-tech, delivers constant volts. Superior quality (02.500-15)

\$72.00 EA



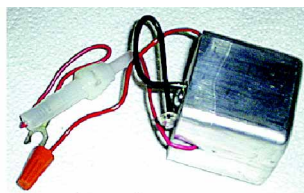
1119005CALL

12v to 6v voltage reducer to operate heater. (02.500-15)

\$18.00 EA



Voltage Booster

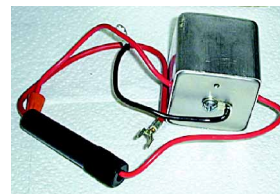


1119006 ALL

6v to 12v booster (1.8-2.25 amps) great for: radar detectors, CB radios, mobile phones, modern stereo radios w/ CD & tape and alarm systems (control only) (02.500-15)

\$70.00 EA

Voltage Booster



1119007 ALL

6v to 12v high current booster (3.7-5.0 amps) great for: radar detectors, CB radios, mobile phones, modern stereo radios w/ CD & tape and alarm systems (control only) (02.500-15)

\$100.00 EA

Restoration Parts

Dash Panel



3847353A 47-53

Die-stamped repro. (-15)

\$325.00 EA

Dash Paint see Section 15T.

Speedometer Assembly



1567794C47-50

0-80 MPH with odometer. Complete w/ backing, lens & bezel. (-15)

\$190.00 EA



1567795C51-53

0-90 MPH with odometer. Complete w/ backing, lens & bezel. (09.748-15)

\$190.00 EA

Speedometer



1567794B47-50

0-80 MPH with odometer. (09.748-15)

\$125.00 EA

350T

Providing part #'s speeds up your order, improves accuracy, and helps us maintain low prices.

See Illustration Index for core charge information and a list of abbreviations. For Body Model information, see 5T. 191



350T: Gauges, Dash Panels, Instrument Glass, Dash Parts, Glove Boxes & Voltage Reducers

Format = Part No., Year, Description, original Chevrolet Part Book Group No., Price and Unit Measure.

Speedometer



1567795B.....51-53
0-90 MPH with
odometer. (09.748-15)
\$125.00 EA

Gauge Cluster



1500924C6V ...47-49
New set. 6 volt, 6
cylinder. Oil (0-30lbs),
Temp (0-220 deg). Red
needles. (09.748-15)
\$350.00 EA

1500924C12V.....47-49
New set. 12 volt, 8 cylinder. Oil (0-60lbs),
Temp (0-220 deg). Red needles.
(09.748-15)

\$350.00 EA



1500924C6V ...50-53
New set. 6 volt, 6
cylinder. Oil (0-30lbs),
Temp (0-220 deg). Red
needles. (09.748-15)
\$350.00 EA

1500924C12V.....50-53
New set. 12 volt, 8 cylinder. Oil (0-60lbs),
Temp (0-220 deg). Red needles.
(09.748-15)

\$350.00 EA

858983R6.....36-39
Rebuilt fits 6 cylinder (\$150 core).
(09.748-15)

\$425.00 EA

1564308R6.....40-46
Rebuilt fits 6 cylinder (\$100 core).
(09.748-15)

\$425.00 EA

1500924R6.....47-54
Rebuilt fits 6 cylinder (\$100 core).
(09.748-15)

\$425.00 EA

Gauges

1500928.....47-48
Ammeter. Red needle. Fits all Comm & Util.
(09.748-15)

\$55.00 EA

1501198.....49-53
Ammeter. White needle. Fits all Comm &
Util. (02.515-15)

\$55.00 EA

Gauges

1507088.....47-48
Oil pressure gauge. Red needle. Fits all
Comm & Util. (02.515-15)

\$55.00 EA

1504701.....49-53
Oil pressure gauge. White needle. Fits all
Comm & Util. (01.803-15)

\$55.00 EA

1511898.....47-48
Temp gauge. Red needle, fits 6 CYL
engine only, exc D/D & COE. (01.803-15)

\$55.00 EA

1511898M.....47-48
Temp gauge. Red needle, fits 8 CYL
engine only (increased line length), exc
D/D & COE. (01.148-15)

\$55.00 EA

1512701.....49-53
Temp gauge. White needle, fits 6 CYL
engine only, exc D/D & COE. (01.148-15)

\$55.00 EA

1512701M.....49-53
Temp gauge. White needle, fits 8 CYL
engine only (increased line length), exc
D/D & COE. (01.148-15)

\$55.00 EA



1516973.....47-48
Fuel Gauge. 6 Volt. Red
needle. Fits all Comm &
Util. (01.148-15)

\$55.00 EA



1516973M.....47-48
Fuel Gauge. 12 Volt.
Red needle. Fits all
Comm & Util.
(03.108-15)

\$55.00 EA



1517169.....49-53
Fuel Gauge. 6 Volt.
White needle. Fits all
Comm & Util.
(03.108-15)

\$55.00 EA



1517169M.....49-53
Fuel Gauge. 12 Volt.
White needle. Fits all
Comm & Util.
(03.108-15)

\$55.00 EA

Gauge Repair

1565912R.....ALL
Speedometer gauge repair service. Parts
extra (04.342-15)

\$150.00 EA

1511051R.....ALL
Temp gauge repair service. New capillary
tube & restoration. Parts extra (09.743-0)

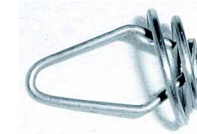
\$150.00 EA

1500381R.....ALL
Electrical gauge repair
service. Parts extra
(01.148-15)

\$120.00 EA

\$10 shipping & handling fee for electrical gauge
repair. Parts needed for repair will be in
addition to servicing.

Clips-Moulding



3654550.....40-46

For moulding across
dash (10 pcs).
(18.550-4)

\$6.00 SET

Instrument Glass



1565308.....40-46
With original markings (Fits 1940 Car, and
1940-46 Truck) (12.118-2)

\$26.75 EA



1564308G.....40-46
With original markings (GMC). (09.748-15)

\$17.00 EA

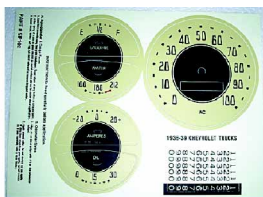
Returns require a return authorization number, please call.

350T: Gauges, Dash Panels, Instrument Glass, Dash Parts, Glove Boxes & Voltage Reducers

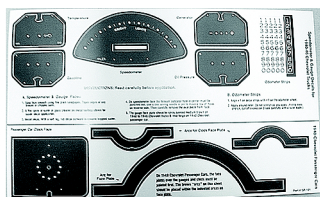


Format = Part No., Year, Description, original Chevrolet Part Book Group No., Price and Unit Measure.

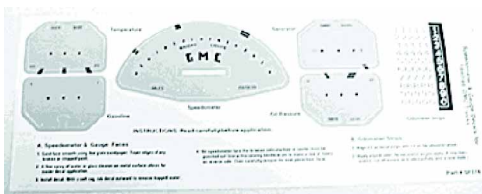
Decal Instrument Set



858983 **36-39**
Instrument set w/ speedo & odometer.
(09.748-15)
\$16.75 EA



1564308B **40-46**
Instrument cluster w/ speedo & odometer.
(09.748-15)
\$13.00 EA

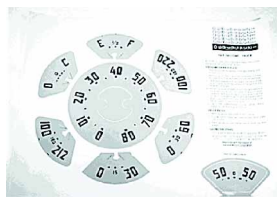


1564308H **40-46**
Instrument cluster w/ speedo & odometer
(GMC). (09.748-15)
\$12.75 EA



1500924B **47-50**
Instrument set w/ speedo & odometer.
(09.748-2)
\$10.00 SET

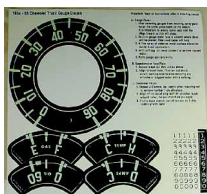
Decal Instrument Set



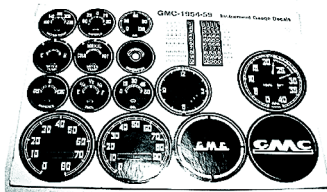
1500924G **47-53**
Instrument set w/ speedo & odometer
(GMC). (09.748-2)
\$10.00 SET



1500924C **51-53**
Instrument set w/ speedo & odometer.
(09.746-2)
\$10.00 SET



1582460C **54**
Instrument set w/ speedo & odometer.
(09.748-15)
\$8.00 EA



1582460G **54-59**
Instrument set w/ speedo & odometer
(GMC). (09.748-15)
\$15.00 EA

Bezel-Gauge Cluster



1565472 **40-46**
Chrome (Chev & GMC). (09.748-15)
\$35.00 EA

1565472B **40-46**
Brown w/ chrome (as original). (09.746-0)
\$47.50 EA



1581526 **47-53**
Chrome for Chev & GMC (cluster w/ speedo). (09.746-15)
\$12.00 EA

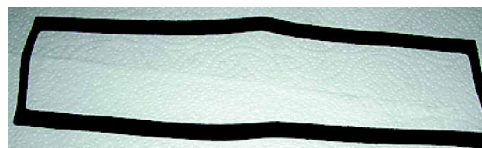


1582659 **54-55**
Chrome. (09.746-15)
\$13.75 EA



1582659S **54-55**
Stainless. (09.746-15)
\$15.50 EA

Gasket-Instrument



1565309 **40-46**
Instrument glass to housing (Chev & GMC). (09.746-2)
\$4.00 EA



1500925 **47-54**
Speedometer Chev & gauge glass (Chev & GMC). (09.749-3)
\$3.50 PR

350T

Providing part #'s speeds up your order, improves accuracy, and helps us maintain low prices.

See Illustration Index for core charge information and a list of abbreviations. For Body Model information, see 5T. 193



350T: Gauges, Dash Panels, Instrument Glass, Dash Parts, Glove Boxes & Voltage Reducers

Format = Part No., Year, Description, original Chevrolet Part Book Group No., Price and Unit Measure.

Speedometer Hand



1567794.....47-50
Super quality (also 52-53 GMC). (09.749-15)
\$9.00 EA



1567795.....51-53
Super! (09.748-15)
\$6.75 EA

Speedometer Cable



1567793.....37-57
W/ original metal housing assembly exc 1939-54. (09.748-2)
\$34.50 EA

158829.....39-54
W/ original metal housing assembly. (04.342-3)
\$35.25 EA

1588291A.....37-57
Cable w/o housing. (04.342-2)
\$15.50 EA

Clock Quartz Conversion

609525R.....ALL
Convert your stock clock to quartz. Rebuild service also to bring new life to your clock (parts extra). (-0)
\$325.00 EA

\$10 shipping & handling fee for conversion. (9.772)

Bushing In Cylinder Head



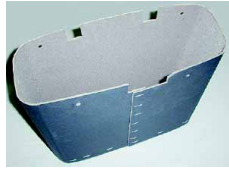
3837160.....38-55
For temp gauge (-2)
\$8.00 EA

Oil Pressure Line



1399637B.....37-54
Engine to gauge (01.150-4)
\$10.50 EA

Glove Box-Cloth Lined



473524C.....36-38
W/ clips (01.519-15)
\$19.00 EA

598886C.....39
W/ clips (16.100-15)
\$19.00 EA

3654001C.....40-46
W/ clips (16.100-15)
\$19.00 EA

Dash Moulding Speaker Grille



3684033.....47-53
Chevrolet. Dash moulding assembly speaker grille w/ script & ashtray assembly. (29-15)
\$110.00 EA



3684033G.....47-53
GMC. (16.083-15)
\$110.00 EA

Decal Radio Grille



306543.....47-53
Chevrolet radio grille. (03.108-15)
\$3.50 EA



306543G.....47-53
GMC radio grille. (18.550-15)
\$4.50 EA

Glove Box-Like Original



473524.....36-38
W/ clips (16.100-15)
\$12.00 EA

598886.....39
W/ clips (16.100-2)
\$12.00 EA

3654001.....40-46
W/ clips (16.100-2)
\$12.00 EA

3676451.....47-49
Without clips. (16.100-2)
\$12.00 EA

3704220.....50-53
W/ clips (16.100-2)
\$12.00 EA

3701366.....54
W/ clips (16.100-2)
\$12.00 EA

3701366G.....54
W/ clips (GMC). (16.100-3)
\$15.00 EA

Screw Set



431616.....ALL
To install glove box (16.100-4)
\$1.50 SET

Glove Box Door

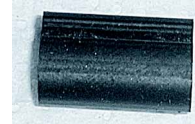


3698751S.....47-53
Stainless (unpainted). (10.261-15)
\$80.00 EA



3698751.....47-53
Stainless with painted details. (16.110-15)
\$80.00 EA

Rubber Bumpers



4072911B.....37-39
Glove box door (rectangle). (16.110-4)
\$3.75 SET

Returns require a return authorization number, please call.

350T: Gauges, Dash Panels, Instrument Glass, Dash Parts, Glove Boxes & Voltage Reducers



Format = Part No., Year, Description, original Chevrolet Part Book Group No., Price and Unit Measure.

Rubber Bumpers



3765243 40-54
Glove box door (round).
(11.139-4)
\$1.00 PR

Glove Box Light



985772 37-54
Replacement w/ bulb
(10.263-15)
\$11.00 EA

Striker



3701376 54-59
Glove box latch.
(10.275-2)
\$7.50 EA

Gasket



4099314C 40-53
Glove box lock to door.
(16.110-4)
\$3.50 EA



4566764A 54
Glove box lock to door.
(16.110-3)
\$1.50 EA

Glove Box Lock



4099314 40-53
Assembly with key,
NOS. (16.110-15)
\$30.00 EA

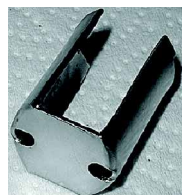


4566764B 54
Assembly with case &
key. (16.110-15)
\$30.00 EA



4099314B 40-53
Retainer for glove box
lock assembly.
(10.266-15)
\$4.00 EA

Glove Box Lock



4599106..... 54-59
Retainer for glove box
lock assembly.
(16.110-2)
\$2.50 EA



4099314A 40-54
Repair Kit (hook & pin).
(10.267-3)
\$7.00 KIT

Key



3694624..... 35-57
Original GM octagon
head. Fits ignition, door
& spare tire locks.
(16.110-2)
\$1.50 EA



601272..... 35-54
Original GM round
head. Fits trunk, glove
box & locking gas cap
(02.187-3)
\$2.00 EA

Odds & Ends

Please call for availability on all Odds & Ends parts; once part is sold, it may no longer be in stock.

1500558 40-46
Ammeter. Fits 40 Pass & 41-46 Truck
(NOS). (02.187-15)
\$60.00 EA

1500928 47-48
Ammeter (COMM, Utility) (02.055-0)
\$50.00 EA

1501471 54
Ammeter NOS (28*000-0)
\$37.50 EA

1500998 47-51
Amp gauge GMC (28*000-0)
\$45.00 EA

13331 39-46
Block off plate for wiper motor. Right side
(NOS) (GMC-0)
\$20.00 EA

01651212K ALL
Chrome knob (26<000-4)
\$4.00 EA

Odds & Ends

1516973G 47-53
Cluster gear bezel fits GMC has yellow
face (09.709-0)
\$15.00 EA

3684037 47-53
Dash moulding below speaker (09.748-0)
\$30.00 EA

603355 39
Dashboard, flat flaxe cowl, excellent
(16.081-0)
\$125.00 EA

1508246 55-57
Oil Pressure Gauge (26~000-0)
\$50.00 EA

13740 50
Glove Box Door w/ lock GMC (Used)
(01.803-0)
\$25.00 EA

1500924 47-53
Instrument glass, used (26*000-0)
\$15.00 EA

1505467 36-39
Oil Gauge NOS (36 Pass, 37-39 COMM)
(09.748-0)
\$35.00 EA

1515207 36-39
Oil Gauge NOS (36 Pass, 37-9 COMM)
(28~000-0)
\$35.00 EA

1506373 40-46
Oil Gauge- 40 Pass, 41-46 Truck (NOS)
(28~000-0)
\$50.00 EA

1507401 49-53
Oil gauge white needle (COMM, Utility)
(28-0)
\$50.00 EA

1507963 47-53
Oil Pressure Gauge, 60 lbs (28*000-0)
\$50.00 EA

1506379 41-46
Oil Pressure Gauge GMC 0-80 PSI NOS
(28^000-0)
\$65.00 EA

1507088 47-48
Oil Pressure Gauge Red Needle (NOS)
(28*000-0)
\$50.00 EA

1506092 40-42
Shelf worn (28*000-0)
\$45.00 EA

350T

Providing part #'s speeds up your order, improves accuracy, and helps us maintain low prices.

See Illustration Index for core charge information and a list of abbreviations. For Body Model information, see 5T. 195

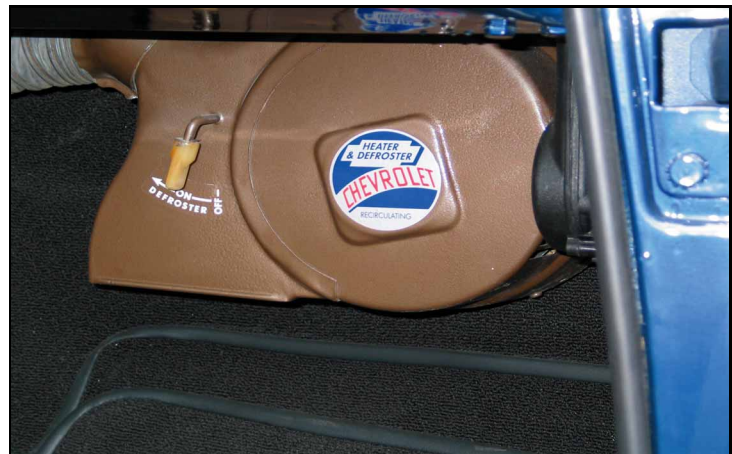
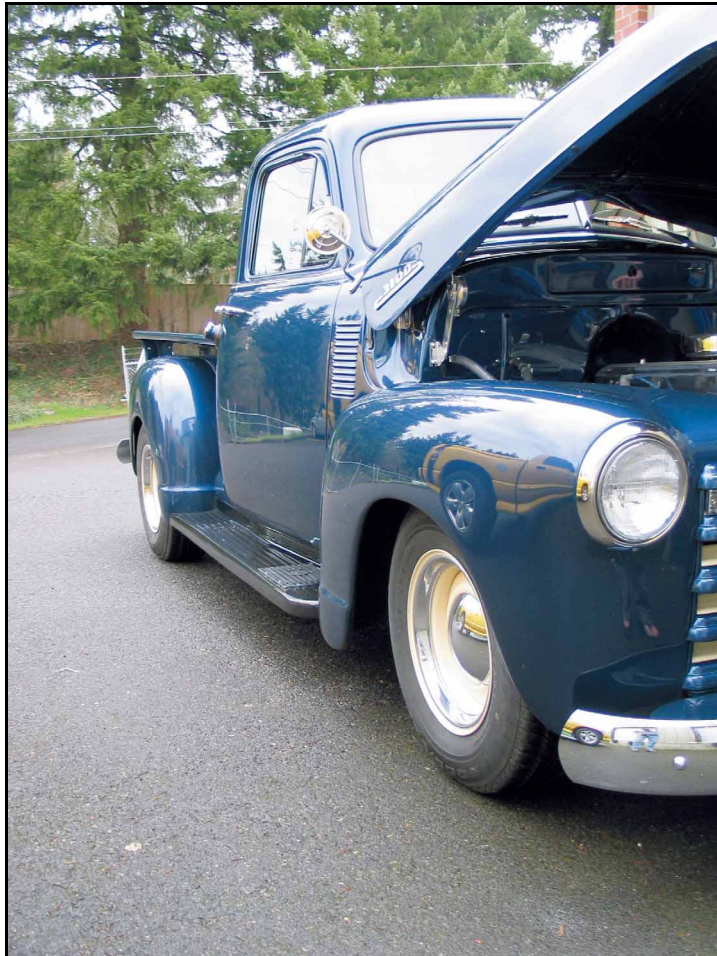
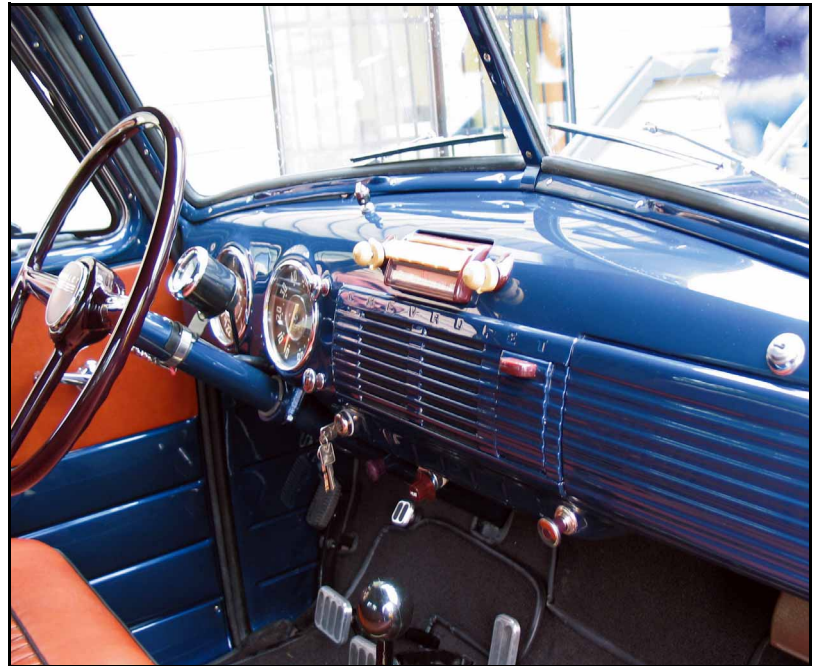


350T: Gauges, Dash Panels, Instrument Glass, Dash Parts, Glove Boxes & Voltage Reducers

Format = Part No., Year, Description, original Chevrolet Part Book Group No., Price and Unit Measure.

Odds & Ends

- 1565473** **40-46**
Retainer - instrument face (1.803-0)
\$15.00 EA
- 858983N** **34-39**
Speedometer 34-36 Master, 39-39 Truck
(09.747-0)
\$125.00 EA
- 1511960** **47-53**
Temp gauge GMC (09.743-0)
\$100.00 EA
- 1511960U** **47-53**
Temp gauge GMC. Needs new needle
(Used) (GMC-0)
\$60.00 EA
- 1501198N** **49-53**
Ammeter. Fits comm & utility 54-55 FFC
(NOS) (GMC-0)
\$50.00 EA



1953—Rodger Lance, Washington

Returns require a return authorization number, please call.

360T: Radios, Antenna & Related



Format = Part No., Year, Description, original Chevrolet Part Book Group No., Price and Unit Measure.

Street Rod Parts

1947-53 New Radio

Small size, big features! Original looking unit with current day audio technology. Fits stock dash radio opening without modifications. Shallow 3¼ inch case depth allows room for dash components such as electric wipers, air conditioning, etc. 4 × 45 watts RMS output, allows up to 180 watts of audio power. Original style AM dial scale in foreground with FM dial scale in background. Analog controls look and feel like the original radio. Made in the USA. 1 year guarantee.



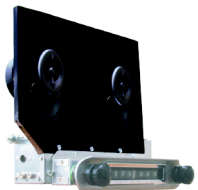
986444R 47-53
(09.650-15)
\$684.75 EA

1954-55 (1st Series) New Radio

First time a NEW radio has been available for this truck in 50 years! Offers the same features as the above unit plus: Chrome plated die cast nose piece looks original. Includes primed dash bezel exactly like the original (must be painted to match) and correct knobs. Optional Dash Speaker (shown) provides two 4"x 6" 3-way speakers that fit in original 6"x 9" opening.



986771R 54-55
(09.650-15)
\$500.00 EA



986771S 54-55
Optional 4" x 6"
speakers. (09.650-15)
\$100.00 PR

Voltage Booster

RADIOCONV.2 ALL
12v Voltage Booster For 6v Vehicles
(09.650-15)
\$100.00 EA

Restoration Parts

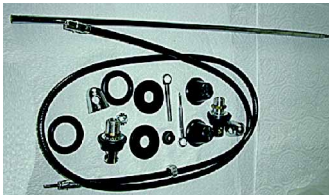
Antenna



985996R..... ALL
2 post side cowl mount. (09.650-2)
\$30.00 EA



984995R..... ALL
Cowl or fender top replacement. (09.645-2)
\$21.00 EA



985531 39-46
W/ original side mount posts. Superior!
(09.645-2)
\$140.00 EA



986069 47-54
W/ template. Superb Reproduction.
(09.645-15)
\$70.00 EA

Antenna Eye Bolt



603797..... 39-46
Antenna upper eye bolt
for base takes 2 (1941
uses 1). (09.645-2)
\$21.25 EA

Antenna Base



603795 39-46
Bakelite post base, 39-46 (takes 2). (09.644-3)
\$23.00 EA

Antenna Base & Nut



986069A 47-54
Base & nut. Fits
Bakelite. (09.644-15)
\$18.00 SET

Antenna Pad



605184 39-46
Rubber pad for bakelite
post (original antenna).
(09.645-15)
\$8.25 PR



986069C 47-54
Rubber pad for antenna
base. (09.645-15)
\$4.00 EA

1937 Radio

985252A 37
Tube set, 6-tube single unit radio #985252.
(09.645-15)
\$107.00 SET

1938 Radio



7232768 38
Radio knob, ivory.
(09.650-15)
\$9.00 EA

1939 Radio



7236509 39
Radio knob, rose tan.
(09.650-15)
\$9.00 EA

985286A 38-39
Tube set, 6-tube single unit radio #985286.
(09.650-2)
\$170.00 SET

360T

Providing part #'s speeds up your order, improves accuracy, and helps us maintain low prices.

See Illustration Index for core charge information and a list of abbreviations. For Body Model information, see 5T. 197

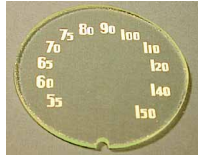


360T: Radios, Antenna & Related

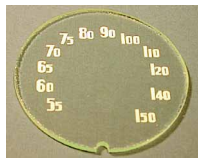
Format = Part No., Year, Description, original Chevrolet Part Book Group No., Price and Unit Measure.

1939 Radio

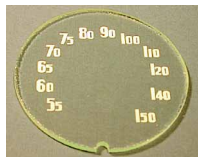
985286A 38-39
Tube set, 6-tube single unit radio #985286.
(09.650-2)
\$170.00 SET



7232626 37-39
Radio dial lens, 2in. diameter. (09.650-3)
\$19.00 EA



7232626 37-39
Radio dial lens, 2in. diameter. (09.650-3)
\$19.00 EA



7232626 37-39
Radio dial lens, 2in. diameter. (09.650-3)
\$19.00 EA

1940 Radio



7239043 40
Radio knob, ivory.
(09.650-15)
\$9.00 EA

985538A 40
Tube set, 5-tube single unit radio #985538.
(09.650-15)
\$76.00 SET

1940-1941 Radio

1213876 40-41
Radio dial lens, 3-1/2in. x 1-1/4in., glass.
(09.650-15)
\$23.50 EA



7238833 40-41
Radio dial lens, 3-1/2in. x 1-1/4in., plastic.
(09.650-15)
\$22.00 EA

985651A 40-41
Tube set, 5-tube plug in portable radio #985651. (09.650-15)
\$52.00 SET

985651A 40-41
Tube set, 5-tube plug in portable radio #985651. (09.650-15)
\$52.00 SET

1941 Radio



604369 41
Radio knob, chrome with swirl center.
(09.650-15)
\$9.00 EA

985696A 41
Tube set, 5-tube single unit radio #985696.
(09.650-15)
\$98.00 SET

1942-1946 Radio



7242249 42-46
Radio knob, ivory w/ copper swirl center.
(09.650-15)
\$9.00 EA

985792A 42-46
Tube set, 5-tube single unit radio #985792.
(09.650-15)
\$78.00 SET

1947-1953 Radio



986264 47-53
Radio knob, tan.
(09.650-15)
\$9.00 EA



986264A 47-53
Disk dummy (knob) behind front radio knob.
(09.650-15)
\$9.00 EA



986264B 47-53
Disk w/ lever (knob) behind front radio knob.
(09.650-15)
\$9.00 EA



986444C 47-53
Radio bezel, teardrop behind knobs.
(09.650-15)
\$9.00 EA

1947-1953 Radio



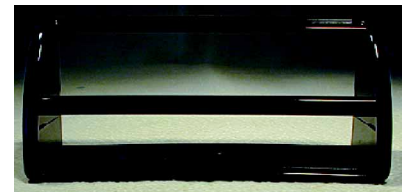
986444A 47-53
Radio bezel gasket (2 pcs). (09.650-15)
\$3.25 PR



7256902 47-50
Radio dial lens, molded plastic. (09.650-15)
\$55.00 EA



986444D 47-53
Pushbuttons (5 pcs). (09.650-15)
\$29.50 SET



986694D 47-53
Radio face housing, maroon. (09.650-15)
\$17.00 EA



3684033 47-53
Dash moulding assembly speaker grille w/ script & ashtray assembly. (09.650-15)
\$110.00 EA



3684033G 47-53
Dash moulding assembly speaker grille w/ script & ashtray assembly, GMC. (16.083-15)
\$110.00 EA



9864445 47-53
Rubber seal, radio speaker to dash. (16.083-15)
\$8.50 EA

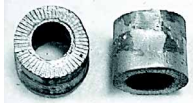
Returns require a return authorization number, please call.

360T: Radios, Antenna & Related



Format = Part No., Year, Description, original Chevrolet Part Book Group No., Price and Unit Measure.

1947-1953 Radio

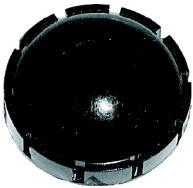


986444F 47-53
Spacers, front of radio to dash. Lower (2 pcs). (09.650-15)
\$8.00 PR

986067A.....47-50
Tube set, 6-tube single unit radio #986067. (09.650-15)
\$90.00 SET

986443A.....51-53
Tube set, 6-tube single unit radio #986443. (09.650-15)
\$90.00 SET

1954 Radio



986694E 54
Radio knob, black (outer). (09.650-15)
\$9.00 EA



986694J 54
Radio knob, GMC, gray (outer). (09.650-15)
\$9.00 EA



986694H 54
Disk dummy (knob) black behind radio knob. (09.650-15)
\$9.00 EA



986694K 54
Disk dummy (knob), gray, GMC, behind radio knob. (09.650-15)
\$9.00 EA



986694 54
Disk w/ lever (knob), black, behind radio knob. (09.650-15)
\$9.00 EA



986694L 54
Disk w/ lever (knob) gray, GMC, behind radio knob. (09.650-15)
\$9.00 EA

1954 Radio



986669B 54
Radio dial lens. (09.650-15)
\$19.00 EA



986668B 54
Radio dial lens, GMC. (09.650-15)
\$12.00 EA



986770C 54
Radio speaker cover, cardboard. (09.650-15)
\$9.50 EA

986770A.....54
Tube set, 6-tube single unit radio #986770. (09.650-15)
\$100.00 SET



986771BKT54-55
1st Series radio mounting bracket (09.650-15)
\$40.00 EA

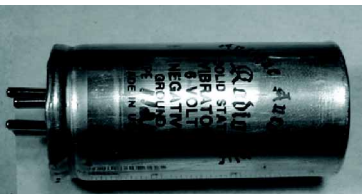
Radio Tubes

121192437-54
OZ-4. Solid state (\$15 core-exchange). (09.650-15)
\$16.00 EA



6V6GT.....ALL
Glass tubes. (09.650-3)
\$30.00 EA

Vibrator



7239124E.....37-38
6v w/ negative grounds. Solid state, no more radio hum (if original vibrator doesn't hum, it's time to replace it). (09.650-2)
\$55.00 EA

Vibrator



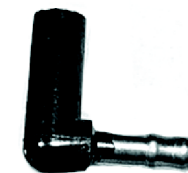
7239124 39-54
6v w/ negative grounds. Solid state, no more radio hum (if original vibrator doesn't hum, it's time to replace it). (09.650-15)
\$37.00 EA



7239124R..... ALL
12v w/ negative grounds. Solid state, no more radio hum (if original vibrator doesn't hum, it's time to replace it). (09.650-15)
\$37.00 EA

Note: Radio & Heater Paint see Section 15T.

Radio Suppressor



7230032..... 37-54
Angled (09.650-4)
\$30.00 EA

Odds & Ends

Please call for availability on all Odds & Ends parts; once part is sold, it may no longer be in stock.

605300N..... 42-48
Knob. Radio (small ivory w/ swirl) (09.650-0)
\$15.00 EA

7239124U..... 39-54
Vibrator - 6 volt used. (09.650-0)
\$20.00 EA

360T

Providing part #'s speeds up your order, improves accuracy, and helps us maintain low prices.

See Illustration Index for core charge information and a list of abbreviations. For Body Model information, see 5T. 199



370T: Cowl Vents, Wiper Motors, Wiper Arms, Knobs & Windshield Washers

Format = Part No., Year, Description, original Chevrolet Part Book Group No., Price and Unit Measure.

Street Rod Parts

Wiper Motor Electric Kit



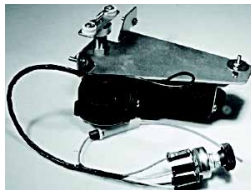
- 598989H**..... 37-46
6v, w/ arm & blade easy installation.
(16.563-15)
\$155.00 EA
- 598989G**..... 37-46
12v, w/ arm & blade easy installation.
(16.064-15)
\$156.50 EA

Wiper Motor Electric



- 598989E**..... 37-46
6v. Also fits GMC, requires some modification to fit.
(16.064-15)
\$55.00 EA

- 598989F**..... 37-46
12v. Also fits GMC, requires some modification to fit. (16.064-3)
\$55.00 EA



- 4089935M**..... 47-53
2 speed & self park (6v). (16.064-15)
\$187.50 EA
- 4089935N**..... 47-53
2 speed & self park (12v), also fits GMC.
(16.064-15)
\$205.00 EA
- 3710004M**..... 54
2 speed & self park (6v). Comes w/ original style knob. (16.064-15)
\$175.00 EA
- 3710004N**..... 54
2 speed & self park (12v), also fits GMC.
(16.064-15)
\$205.00 EA

Intermittent Delay Switch



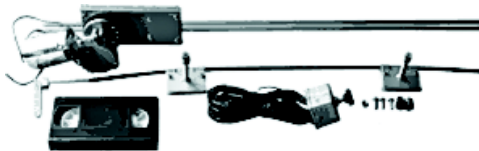
- 4073750D**..... ALL
For electric wiper motors (16.064-15)
\$64.00 EA

Electric Wiper Conversion - Bolt-in



- 598989K**..... 39-46
Clean Wipe System. Replaces factory wiper system. Comes with 12 volt, two-speed electric motor, complete with bracketing, linkage arms, wiper transmissions, wiper arms & blades, wiring and switch. Designed to fit in stock location above the windshield. For wiper delay add part #4073750D. (16.064-0)
\$330.00 KIT

Electric Wiper Conversion Kit



- 598988E**..... 37-46
Replaces motor & 2 transmissions. Quiet cable drive & motor can be mounted outside passenger compartment for quiet operation. (16.064-15)
\$265.00 KIT
- 598988F**..... 37-46
Intermittent-replaces motor & 2 transmissions. Quiet cable drive & motor can be mounted outside passenger compartment for quiet operation. (16.064-15)
\$299.00 KIT
- 4089934E**..... 47-54
Replaces motor & 2 transmissions. Quiet cable drive & motor can be mounted outside passenger compartment for quiet operation. (16.064-15)
\$325.00 KIT

Electric Wiper Conversion Kit

- 4089934F**..... 47-54
Intermittent-replaces motor & 2 transmissions. Quiet cable drive & motor can be mounted outside passenger compartment for quiet operation (16.064-15)
\$359.00 KIT

Wiper Arm & Blade (Billet)

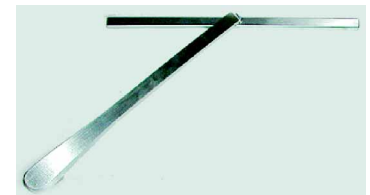
For use with electric wiper conversion kits. These arms and blades come in 10 inch lengths. They are designed to be cut to length as needed. All arms have adjustable blade angle feature. The arms come with a brushed finish, but can be finished to suit individual needs.



- 3683910RL**..... ALL
Angle arm-left hand (curved windshield) (-15)
\$39.50 SET



- 3683910RR**..... ALL
Angle arm-right hand (curved windshield) (10.146-15)
\$39.50 SET



- 3683910S**..... ALL
Straight arm-left or right (flat windshield) (10.146-15)
\$39.50 SET

Returns require a return authorization number, please call.

370T: Cowl Vents, Wiper Motors, Wiper Arms, Knobs & Windshield Washers



Format = Part No., Year, Description, original Chevrolet Part Book Group No., Price and Unit Measure.

Wiper Cap



4601065 37-54
Chrome cap replaces wiper arm on shaft (10.146-15)
\$17.00 PR



4601065C 37-54
Chrome cap replaces wiper arm on shaft. Bullet shaped (10.159-15)
\$13.25 PR

Restoration Parts

Header Panel



593369 36-38
Mounts above windshield (fiberglass). (01.664-15)
\$80.00 EA

598772 39-46
Mounts above windshield (fiberglass). (16.562-15)
\$93.75 EA

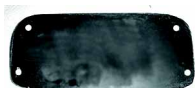
Cover-Wiper Motor Access Hole



593351L 36-38
Left (fiberglass). (03.900-15)
\$19.00 EA



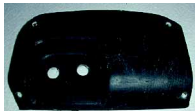
593352R 36-38
Right (fiberglass). (16.563-15)
\$19.00 EA



593353 36-38
Blank (right hand side w/out cover-wiper) (fiberglass). (16.563-4)
\$15.00 EA

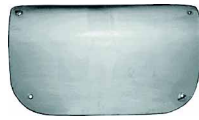


598811L 39-46
Left (fiberglass). (16.563-15)
\$19.00 EA



598813R 39-46
Right (fiberglass). (16.563-15)
\$19.00 EA

Cover-Wiper Motor Access Hole



598814 39-46
Blank (fiberglass). (16.563-15)
\$15.00 EA

Cowl Vent Knob



985261 37-38
Ivory accessory (original 38) (10.159-15)
\$16.00 EA



3656663A 40-46
As original, brown. (09.691-15)
\$8.00 EA



985603 40-46
Ivory accessory (16.130-15)
\$16.00 EA



3682916A 47-53
Side or top vent, maroon. (09.691-15)
\$9.00 EA



3131111 54
Black (16.130-15)
\$9.00 EA

Cowl Vent Seal



373398 34-38
Non-absorbing, molded. (16.130-15)
\$19.00 EA

Cowl Vent Seal



3681067 39-46
Non-absorbing, molded. (16.140-15)
\$17.00 EA

3681067A 39-46
Sponge (16.140-15)
\$9.75 EA



3684389 47-50
Side vent, non-absorb molded. (16.140-4)
\$10.75 EA

3684389A 47-50
Side vent, sponge. (16.140-2)
\$6.00 EA



3682856 47-53
Non-absorb molded. (16.140-2)
\$13.50 EA

3682856A 47-53
Sponge (16.140-15)
\$4.00 EA



3703560 54
Non-absorb molded. (16.140-3)
\$16.25 EA

3703560A 54
Sponge (16.140-15)
\$4.75 EA

Hose



4027764 39-46
Cowl vent drain. (16.140-4)
\$4.00 EA

370T

Providing part #'s speeds up your order, improves accuracy, and helps us maintain low prices.

See Illustration Index for core charge information and a list of abbreviations. For Body Model information, see 5T. 201



370T: Cowl Vents, Wiper Motors, Wiper Arms, Knobs & Windshield Washers

Format = Part No., Year, Description, original Chevrolet Part Book Group No., Price and Unit Measure.

Hose



368365747-54
Cowl vent drain.
(16.127-2)
\$5.00 EA

Bolt



402306039-46
Cowl vent hinge
(shouldered bolt).
(16.127-3)
\$12.50 SET

Wiper Knob



368514147-49
Chrome (16.135-15)
\$7.00 EA



369911750-53
Maroon (16.067-15)
\$7.00 EA



370385354
Black (16.067-15)
\$9.00 EA

Grommet-Wiper Control Link



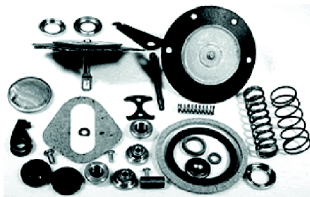
409339747-53
Wiper control link
(10.155-15)
\$1.00 PR

Wiper Control Link



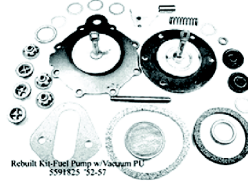
3699117A.....47-53
Rod (16.063-15)
\$4.00 EA

Fuel Pump Rebuild Kit



5591844 37-51
W/ vacuum pump (16.067-15)
\$53.75 EA

Fuel Pump Rebuild Kit



5591825.....52-57
W/ vacuum pump (03.901-15)
\$39.50 EA

Fuel Pump

Tired of your wipers stopping when you get on the accelerator? Replace your fuel pump with one that also has a vacuum pump for consistent wiper movement.



5593259 ALL
W/ vacuum pump for vehicles w/ small block chevrolet V8 (\$20 core).
(16.563-0)
\$72.00 EA



5591457M 37-51
W/ vacuum pump (metal bowl) (-15)
\$63.00 EA



5591457 37-51
W/ vacuum pump (glass bowl) stops slow wipers, original accessory. Also fits GMC. (03.900-15)
\$96.00 EA



5592675M 52-57
W/ vacuum pump (metal bowl) stops slow wipers, original accessory. (03.900-15)
\$72.00 EA



5592675 52-57
W/ vacuum pump (glass bowl) stops slow wipers, original accessory. (03.900-15)
\$86.00 EA

Vacuum Hose



601607 ALL
Wiper motor to engine, 1/4in. i.d. (03.900-4)
\$1.00 FT

Windshield Washer Hose



604041B.....37-50
9 ft, w/ original GM instruction sheet & firewall grommet. (16.067-4)
\$21.00 KIT

Hose Connector 3-way



3682929 ALL
Y wiper & washer, 7/32in. (08.962-4)
\$2.00 EA

Windshield Washer Nozzles



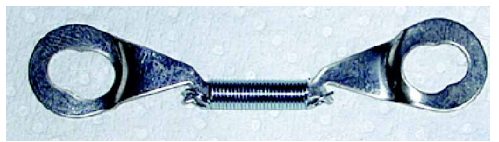
60435440-50
Chrome w/ mounting bracket (tip not included) (16.065-15)
\$20.00 PR

Pivot Rubber Bushings

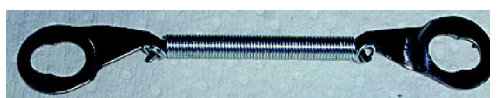


374648347-53
For wiper motor (16.066-15)
\$1.00 PR

Wiper Motor Pivot Linkage Retainer



4065091..... 47-53
For wiper motor (10.158-15)
\$2.00 EA



4570135..... 54-57
For wiper motor (10.158-3)
\$4.00 EA

Returns require a return authorization number, please call.

370T: Cowl Vents, Wiper Motors, Wiper Arms, Knobs & Windshield Washers



Format = Part No., Year, Description, original Chevrolet Part Book Group No., Price and Unit Measure.

Wiper Motor-Vacuum Operated

SPECIFY ALL..... ALL
Rebuild your core (please send motor only- do not send any other parts) (10.158-15)
\$105.00 EA

\$10 shipping & handling for rebuild service.

Wiper Blade



985459.....29-46
8-1/2in. (-4)
\$8.00 EA



985982.....39-46
9in. (10.146-3)
\$6.00 EA



3683905.....47-53
10in. (10.146-3)
\$7.00 EA



3683905S.....54-59
10in. (10.146-15)
\$16.00 EA



561094S.....54-59
11-1/2in. (10.146-15)
\$14.00 EA

Wiper Arm & Blade



603047R.....31-38
7in. stainless arm w/ 8-1/4in. blade (2 pcs). (10.146-15)
\$50.00 SET

Wiper Arm



603047.....31-38
7in. stainless arm (10.146-2)
\$24.00 EA



598991.....39-46
(10.147-4)
\$22.00 EA



3697280.....47-53
Left (10.147-2)
\$20.00 EA



3697282.....47-53
Right (10.147-2)
\$20.00 EA



3730483.....54-59
Left (10.147-2)
\$20.00 EA

Wiper Arm



3722488.....54-59
Right (10.147-2)
\$20.00 EA

Wiper Trans & Link Assy

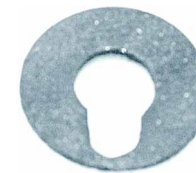


3683915BS.....47-53
Complete upgrade. Oil impregnated brass bushings in transmission. Stainless steel splines, shaft and arm for long life (remove studs from vacuum motor and bolt on new ball studs). Comes with instructions for installation. (16.065-15)
\$275.00 L&R

Gasket



593383.....36-38
Wiper motor bezel to cab (10.147-3)
\$1.50 EA



598993.....39-46
Wiper motor bezel to cab (16.065-2)
\$1.25 EA



3685793A.....47-53
Wiper transmission (16.065-4)
\$3.00 EA



3703860A.....54
Wiper transmission (16.065-3)
\$3.50 PR

370T

Providing part #'s speeds up your order, improves accuracy, and helps us maintain low prices.

See Illustration Index for core charge information and a list of abbreviations. For Body Model information, see 5T. 203



370T: Cowl Vents, Wiper Motors, Wiper Arms, Knobs & Windshield Washers

Format = Part No., Year, Description, original Chevrolet Part Book Group No., Price and Unit Measure.

Chrome Bezel



593384.....**36-38**
Wiper transmission
(16.065-15)
\$15.00 EA



598994.....**39-46**
Wiper transmission
(16.065-15)
\$15.00 EA



3683911.....**47-53**
Wiper transmission
(16.065-15)
\$9.00 PR

Nuts



3683913.....**47-59**
Retains chrome wiper
bezel to cowl
(16.065-15)
\$3.00 PR

Odds & Ends

Please call for availability on all Odds & Ends parts; once part is sold, it may no longer be in stock.

598813U.....**39-46**
Wiper motor access cover. Excellent condition (Used). (-2)
\$30.00 EA

3656663.....**41-46**
Cowl vent linkage (16.563-0)
\$40.00 EA

3654631U.....**40-46**
Handle-Windshield Regulator (16.130-0)
\$25.00 EA

16190.....**47-53**
Top cowl vent door, used (32*000-0)
\$15.00 EA

598811N.....**39-42**
Wiper motor access panel cover. Brown (NOS) (16.125-0)
\$25.00 EA

3683915U.....**47-53**
Wiper trans link left hand (Used) (16.563-0)
\$10.00 EA



1941—Doug Pflugrad, Washington

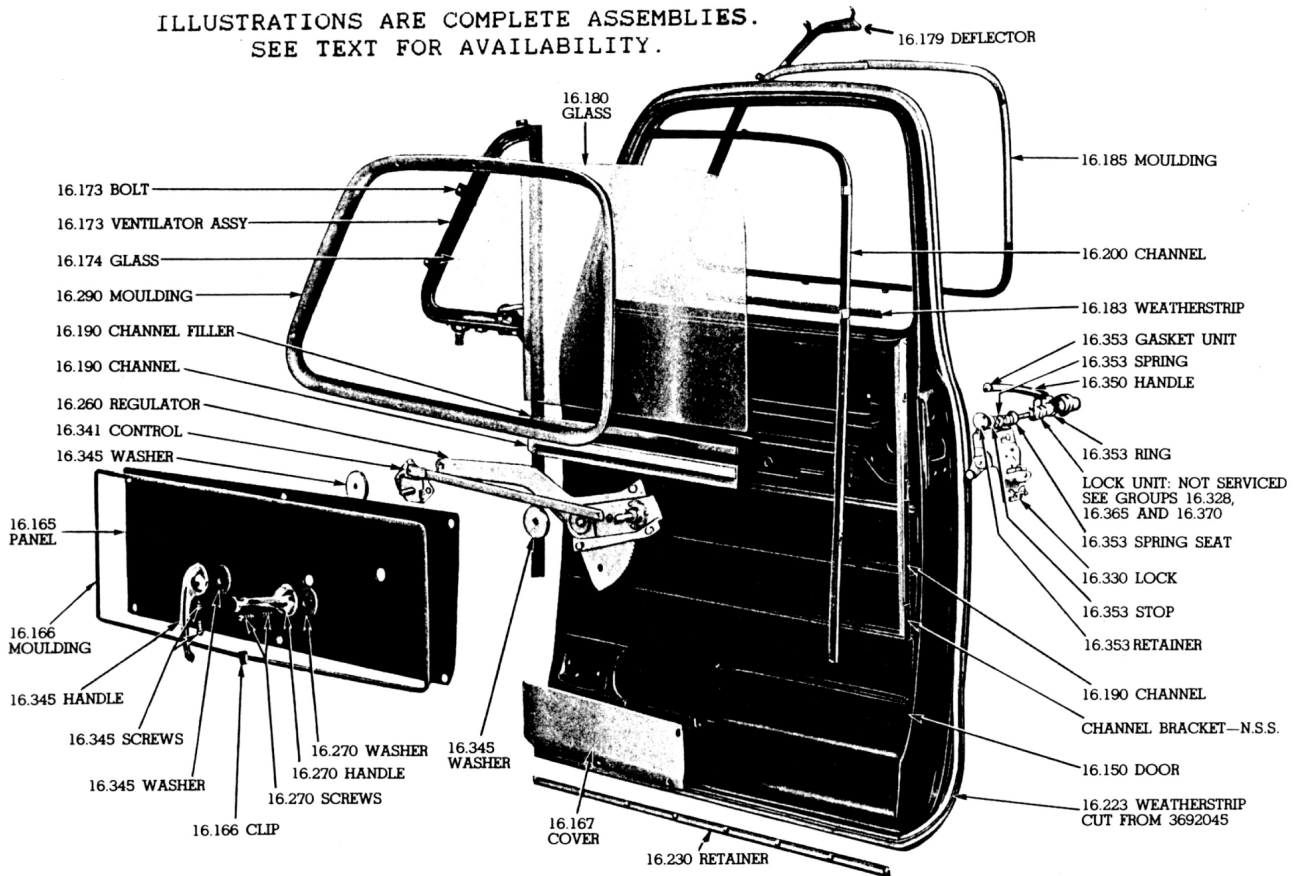
Returns require a return authorization number, please call.

380T: Door Handles, Armrests, Door Latches & Strikers

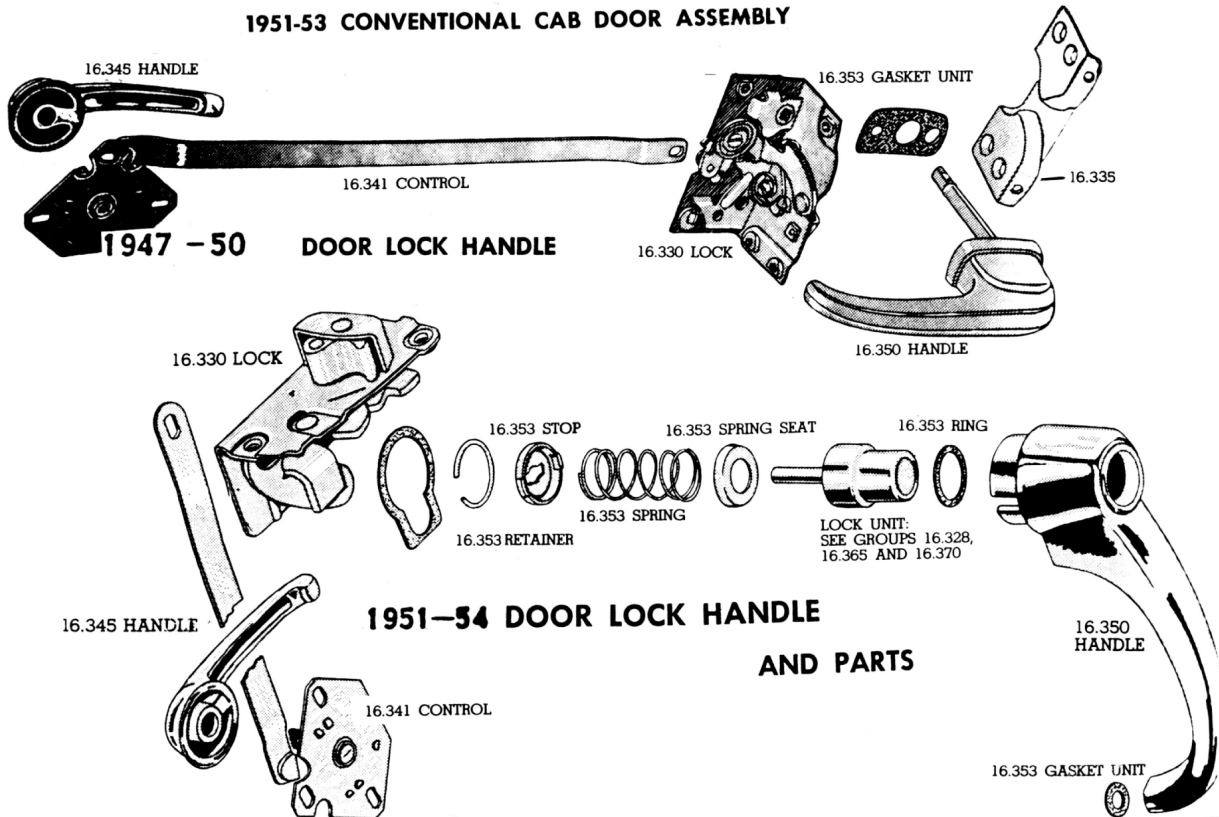


Format = Part No., Year, Description, original Chevrolet Part Book Group No., Price and Unit Measure.

ILLUSTRATIONS ARE COMPLETE ASSEMBLIES.
SEE TEXT FOR AVAILABILITY.



1951-53 CONVENTIONAL CAB DOOR ASSEMBLY



1947 - 50

DOOR LOCK HANDLE

1951-54 DOOR LOCK HANDLE

AND PARTS

380T

Providing part #'s speeds up your order, improves accuracy, and helps us maintain low prices.

See Illustration Index for core charge information and a list of abbreviations. For Body Model information, see 5T. 205



380T: Door Handles, Armrests, Door Latches & Strikers

Format = Part No., Year, Description, original Chevrolet Part Book Group No., Price and Unit Measure.

Note: Window Cranks see Section 460T.

Door Handle Exterior

3654589 39-46

Non-locking.
(13.360-15)

\$30.00 EA



3654589B 39-46

Driver side, Chrome non-locking door handle (not original).
(16.360-15)

\$50.00 EA



3686255 47-51

Left & right (16.360-15)

\$55.00 PR



3698881 52-59

Non-locking pushbutton (left side) & right side w/o pushbutton (install yours or use our pt #3700318). (16.360-15)

\$45.00 PR

Pushbutton

3700318 52-59

For right side door handle w/ lock cylinder & 2 keys. (16.350-15)

\$35.00 EA



Door Handle Exterior Return Spring

3683067A 39-46

Left (16.330-15)

\$9.50 EA



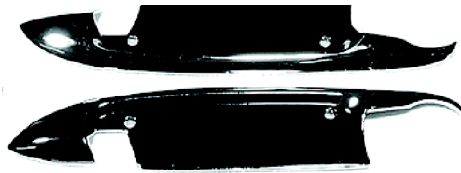
3684168 47-51

Exterior (16.365-15)

\$4.50 EA



Door Handle Exterior Guard



3698881C 52-59

Chrome (16.330-15)

\$18.00 PR

Gasket-Door Handle



603954A 47-51

Door handle & lock (exterior). (16.350-3)

\$4.00 SET

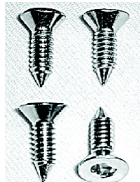


3700098 52-59

Door handle (exterior). (16.353-3)

\$3.50 SET

Screw Set



4147641A 47-51

Door handle bezel (exterior) (4 pcs). (16.353-15)

\$3.00 SET

Door Lock



3684820 47-53

W/ 2 keys, exterior 47-51 right door, also Panel & Suburban. (16.270-15)

\$40.00 EA

Retainer



3676359 47-51

For door lock cylinder. (16.328-15)

\$10.00 EA

Door Lock Gasket



1393155A 42-46

Key (exterior). (16.328-4)

\$1.25 EA

Key



3694624 35-57

Original GM octagon head. Fits ignition, door & spare tire locks. (16.328-2)

\$1.50 EA



601272 35-54

Original GM round head. Fits trunk, glove box & locking gas cap (02.187-3)

\$2.00 EA

Door Lock Knob

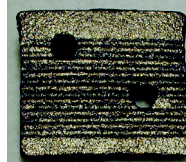


3658537 41-46

Small chrome t-handle. (02.187-15)

\$11.00 EA

Door Latch Striker



598777A 39-46

Replacement. (16.39-15)

\$9.50 EA



3684235B 47-51

(16.335-15)

\$20.00 PR

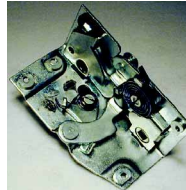


3753185B 52-59

(16.335-15)

\$20.00 PR

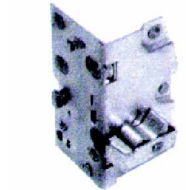
Door Latch Assembly



3684167 47-51

Left (16.335-15)

\$32.50 EA



3684166 47-51

Right (16.335-15)

\$32.50 EA

Returns require a return authorization number, please call.

380T: Door Handles, Armrests, Door Latches & Strikers



Format = Part No., Year, Description, original Chevrolet Part Book Group No., Price and Unit Measure.

Door Latch Assembly



3698813 52-54
Left (16.335-15)
\$50.00 EA



3698814 52-54
Right (16.335-15)
\$50.00 EA

Clutch Head Screw Set



4147641C 52-54
Door latch striker (does both doors) (8 pcs). (16.335-4)
\$6.00 EA

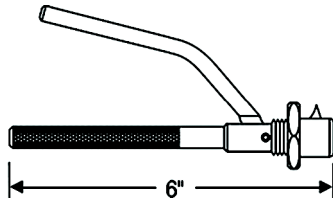


3707583A 47-51
Latch assembly to door (does both doors). (16.270-15)
\$6.00 SET



3707583 52-54
Latch assembly to door (does both doors). (16.270-2)
\$6.00 SET

Ferrule Tool



4088134A..... **ALL**
Installs door handle ferrules. Return tool in same condition as sent for a \$20 refund (Does not work with Ferrule part #4125630). (10.537-15)
\$39.50 EA

Ferrule



4003748 29-38
Chrome, w/ grommet, door handle. (16.270-4)
\$7.75 EA

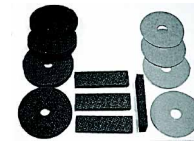
4082056 39-46
Chrome, w/ grommet, door handle. (10.537-4)
\$8.00 EA

Rubber Grommet



4125630A 39-48
Door handle ferrule. (10.537-15)
\$2.00 EA

Gasket-Door Handle



3686114B 47-54
Interior door & window handles with door panel spacers (12pcs). (10.537-2)
\$10.00 SET

Door Handle Interior



373434B 34-38
Chrome. (16.345-15)
\$22.25 EA

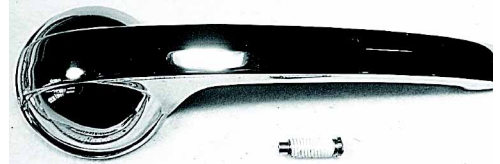


3654593 39-46
Unplated, military army green color (NOS). (16.345-15)
\$20.00 EA

Door Handle Interior

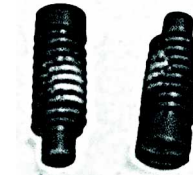


3654593C 39-46
Chrome interior door handle. (16.345-15)
\$30.00 EA

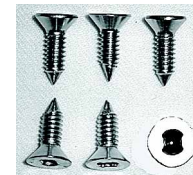


3848873 47-66
(16.345-3)
\$10.50 EA

Screws



3683258 47-53
Retains original GM interior handles. (16.345-0)
\$2.50 EA



4147641B 47-54
Clutch head, attaches the interior door handle remote to the door (6 pcs). (16.270-2)
\$6.00 SET

Clutch Head Driver W/ Bits



DRIVER..... **ALL**
Magnetic driver w/ 5 bits (1/8in., 5/32in., 3/16in., 1/4in., 5/16in.) with Chevs imprint. (16.341-15)
\$22.25 SET

Clutch Head Bits



3685598
1/8in. (1/4in. drive) (08.821-3)
\$4.00 EA

380T

Providing part #'s speeds up your order, improves accuracy, and helps us maintain low prices.

See Illustration Index for core charge information and a list of abbreviations. For Body Model information, see 5T. 207



380T: Door Handles, Armrests, Door Latches & Strikers

Format = Part No., Year, Description, original Chevrolet Part Book Group No., Price and Unit Measure.

Clutch Head Bits



3685592
5/32in. (1/4in. drive)
(08.821-4)
\$4.00 EA



3685594
3/16in. (1/4in. drive)
(08.821-3)
\$4.00 EA



3685593
1/4in. (1/4in. drive)
(08.821-3)
\$4.00 EA



3685595
5/16in. (1/4in. drive)
(08.821-2)
\$6.00 EA

Clutch Bit Holder



3685596
For your 1/4in. drive ratchet. Holds clutch head bits. (08.821-2)
\$6.00 EA

Return Spring



3698879 47-54
Fits remote for interior handle. (08.821-15)
\$6.50 EA

Remote w/ Linkage



3698877 47-55
Left side for inside handle (original 52-55). (16.342-15)
\$28.00 EA

3698878 47-55
Right side for inside handle (original 52-55). (16.341-15)
\$28.00 EA

Door Arm Rests

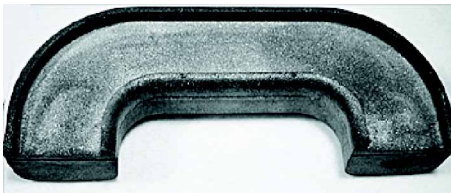


986154 47-54
Brown (super!) (16.341-15)
\$41.75 EA

986154D 47-54
Black (super!) (16.155-15)
\$41.75 EA

986154M 47-54
Maroon, original (super!) (16.155-15)
\$41.75 EA

Arm Rest Rubber Pad



3684360 47-54
(16.155-15)
\$20.00 EA

Arm Rest Bracket

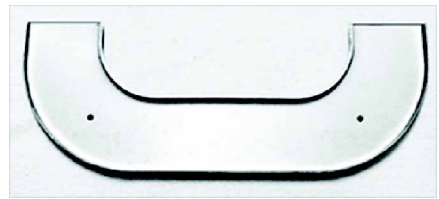


3684383 47-54
Black (16.155-15)
\$24.00 EA

Arm Rest Bracket

3684384 47-54
Brown (16.155-15)
\$24.00 EA

Metal Trim Plate



3684383A 47-54
For arm rest. (16.155-15)
\$12.00 EA

Kick Panels



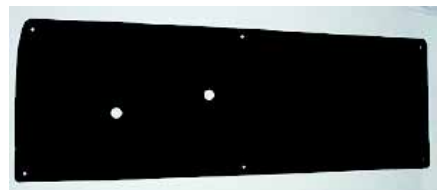
474791 36-38
Inner, brown, black or gray, specify color when ordering. (16.155-2)
\$16.00 L&R



609526 39-46
Inner, brown, black or gray, specify color when ordering. (16.700-3)
\$16.00 L&R

609527 47-54
Inner, black, brown or gray, not original. Specify color when ordering. (16.700-2)
\$16.00 L&R

Door Panels Cardboard



3700543A 47-54
Original leather grain brown, black or maroon (specify color). (16.700-0)
\$16.00 L&R

3700543 47-54
Black, brown or gray, specify color when ordering. (16.165-0)
\$12.00 L&R

Returns require a return authorization number, please call.

380T: Door Handles, Armrests, Door Latches & Strikers



Format = Part No., Year, Description, original Chevrolet Part Book Group No., Price and Unit Measure.

Door Panel-Metal Frames

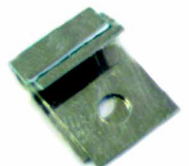


- 3686120**47-54
With clips. (16.165-15)
\$35.00 PR
- 3686120S**.....47-54
Polished stainless steel with clips.
(16.166-15)
\$40.00 PR

Metal Frame Joint Clips



- 3697673** 47-54
Zinc (16.166-15)
\$1.75 PR



- 3697673S** 47-54
Polished Stainless
(16.166-15)
\$2.00 PR

Retainer Button



- 3707152** 54
Door panel cardboard,
use 12. (16.166-4)
\$1.00 EA

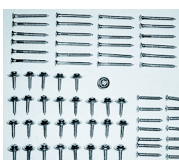
Screw Set



- 3684161A** 47-53
Door panel, cardboard,
does both doors (12
pcs). (16.165-4)
\$3.25 SET



- 3694071** 47-50
Attaches upper and
lower door frame glass.
(16.290-15)
\$5.00 SET



- 3694284B** 47-54
Headliner, door panel,
window & windshield
garnish mouldings.
(16.290-3)
\$13.50 KIT

Screw Set



- 3684481B** 47-54
Window garnish
mouldings, 2 doors.
(16.190-3)
\$5.25 SET

Interior Screws



- 3654597C** 37-50
8 x 32 x 1/2in. clutch
head (10 pcs).
(16.290-4)
\$3.00 SET



- 3654597A** 37-50
8 x 32 x 1/2in. clutch
head (100 pcs).
(16.170-4)
\$20.50 SET

Odds & Ends

Please call for availability on all Odds & Ends parts; once part is sold, it may no longer be in stock.

- 3848873U**47-66
Door handle (Used) (-0)
\$15.00 EA
- 3684166U**47-51
Door latch assembly, used fits right hand
(16.345-0)
\$30.00 EA
- 3698813U**52-54
Door latch, left side (Used). (16.335-0)
\$30.00 EA
- 3658536U**39-42
Door latch, right side (Used). (16.335-0)
\$40.00 EA
- 598907**39-46
Door Lock Remote (16.335-0)
\$35.00 EA
- 3654593N**39-46
Exterior door handle (NOS). Shelf worn.
Not plated or painted. (16.341-0)
\$7.50 EA
- 3654593U**39-46
Door handle. Chrome. Good condition.
(16.345-0)
\$30.00 EA
- 3695977**51-54
Interior window moulding stainless steel
(left) used in good condition (13.345-0)
\$45.00 EA

Odds & Ends

- 3684175U**..... 47-50
Mouldings door garnish & reveal (16.290-0)
\$175.00 L&R
- 3698885** 52-57
Spring-Door Handle Push Button
(36~000-0)
\$2.00 EA

380T

Providing part #'s speeds up your order, improves accuracy, and helps us maintain low prices.

See Illustration Index for core charge information and a list of abbreviations. For Body Model information, see 5T. 209



390T: Door Hinge Pins & Check Links

Format = Part No., Year, Description, original Chevrolet Part Book Group No., Price and Unit Measure.

Hinge Seal



380777747-55
Back door, Panel &
Suburban (4 pcs).
(10.450-15)
\$9.50 SET

Hinge Pin



59865329-46
(16.325-15)
\$1.50 EA



598653S29-46
Stainless steel.
(16.323-4)
\$5.75 EA



598653A29-46
For Accessory Mirror.
(16.323-2)
\$2.00 EA



384768547-54
1/8in. Oversize.
(16.323-3)
\$1.75 EA



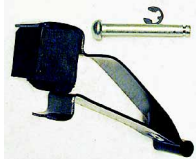
4023559B39-54
Pin w/ bushings. Fits
back door on Suburban
& Panel (3 pcs).
(16.323-3)
\$3.50 SET

Door Strap Check Bracket



59640939-46
Replaces original which
is normally rusted &
broken. (10.466-15)
\$18.00 EA

Door Check Link Assembly



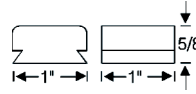
368174739-46
W/ rubber, pin & spring.
(16.440-0)
\$19.25 EA

Door Check Link Springs



369044747-54
(16.430-15)
\$4.00 PR

Check Link Bumper



3711312 47-59
Back door (Panel &
Suburban) (16.323-15)
\$18.50 PR

Odds & Ends

Please call for availability on all Odds & Ends parts; once part is sold, it may no longer be in stock.

3688765U 47-55
Hinge. Door, left lower (Used) exc COE.
(-0)
\$40.00 EA

3688763U 47-55
Hinge. Door, left upper (Used) exc COE.
(16.320-0)
\$40.00 EA

3688764U 47-55
Hinge. Door, right upper (Used) exc COE.
(16.320-0)
\$40.00 EA

Returns require a return authorization number, please call.

400T: Door Bumpers, Windlace & Weatherstrip



Format = Part No., Year, Description, original Chevrolet Part Book Group No., Price and Unit Measure.

Door Windlace



3847443 36-49
Black rubber
(16.320-15)
\$30.75 PR

3681081K 37-40
Black vinyl covered (16.225-15)
\$30.00 PR

3681081N 37-40
Brown vinyl covered (16.225-15)
\$30.00 PR

3681081G 37-40
Gray vinyl covered (16.225-15)
\$30.00 PR

3681082 41-46
Black vinyl covered (16.225-15)
\$30.00 PR

3653999 41-46
Brown vinyl covered (16.225-15)
\$30.00 PR

3681082G 41-46
Gray vinyl covered (16.225-15)
\$30.00 PR

3692458A 50-54
Black rubber (16.225-4)
\$38.50 SET

3692458 50-54
Gray tan rubber (16.225-0)
\$37.50 PR

3692458B 50-54
Dark blue, original, 54-55 Deluxe cab
(16.225-15)
\$44.25 PR

3692458G 50-54
Dark green, original, 54-55 Deluxe cab
(16.225-15)
\$44.25 PR

Windlace Retainer



3685651B 47-55
Left side, door. 3 pcs. (16.225-15)
\$70.00 EA

Windlace Retainer



3685652B 47-55
Right side, door. 3 pcs. (16.230-15)
\$70.00 EA

Door Sill Seal



3681212 37-46
Attaches to cab, black (6 foot length)
(16.230-4)
\$16.00 EA

3676019 47-49
Attaches to cab, black (16.225-4)
\$8.75 SET

3700548 50-54
Attaches to cab (black) (16.225-15)
\$12.00 PR

3700547 50-54
Attaches to cab, gray/ brown (16.225-15)
\$19.25 PR

3700548B 50-55
Attaches to cab, dark blue, original, 54-55
Deluxe cab (16.225-15)
\$18.25 PR

3700548G 50-55
Attaches to cab, dark green, original 54-55
Deluxe cab (16.225-15)
\$18.25 PR

Retainer



3683660S 47-49
Stainless (door sill seal) on cab (16.225-15)
\$36.00 EA

3683660 47-49
Steel, door sill seal, on cab (16.230-15)
\$15.00 EA

3693500S 50-54
Stainless (door sill seal) on cab (16.230-3)
\$64.00 SET

Retainer

3693500 50-54
Steel, door sill seal, on cab (16.230-3)
\$24.00 PR

Screws



3654597 47-49
Door sill metal retainer
(16 piece) (16.230-4)
\$3.00 SET



3654598 50-54
Door sill metal retainer
(8 piece) (16.231-4)
\$2.25 SET

Door Weatherstrip



3700548A 37-54
Original 47-54, does 2
doors (16.231-4)
\$25.00 PR



4143075A 39-46
Panel. For both rear
doors (16.225-15)
\$16.00 PR



3700548A 47-54
Panel & Suburban,
does rear 2 doors
(10.694-4)
\$23.75 PR

Metal Retainer

3691189S 47-54
Weatherstrip on door bottom (original 50-59) stainless (16.225-3)
\$28.00 PR

3691189 47-54
Weatherstrip on door bottom (original 50-59) (16.230-3)
\$16.00 SET

Weatherstrip Clips



4076045 41-54
Retains back door
weatherstrip. Fits Panel
& Suburban (5 pcs)
(16.230-4)
\$3.00 SET

Providing part #'s speeds up your order, improves accuracy, and helps us maintain low prices.

See Illustration Index for core charge information and a list of abbreviations. For Body Model information, see 5T. 211



400T: Door Bumpers, Windlace & Weatherstrip

Format = Part No., Year, Description, original Chevrolet Part Book Group No., Price and Unit Measure.

Weatherstrip Cement

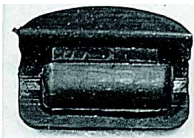


511114..... ALL
Black weatherstrip cement, 5-oz tube. Superior product! (10.695-2)
\$7.50 EA

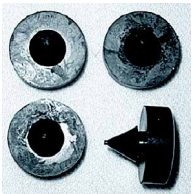
Door Bumper



3681070.....30-46
Door hinge post, 1in. x 1/4in. thick, held by screw (2 pcs). (08.800-3)
\$4.50 SET



3681078.....36-46
Door jamb, rear. 5/8in. x 7/8in. x 1-7/16in. 41-46 uses 4 each. (16.400-15)
\$4.25 EA



3684752B.....47-54
Door jamb, rear (4 pcs). (16.400-4)
\$3.50 SET

Dovetail Bumper



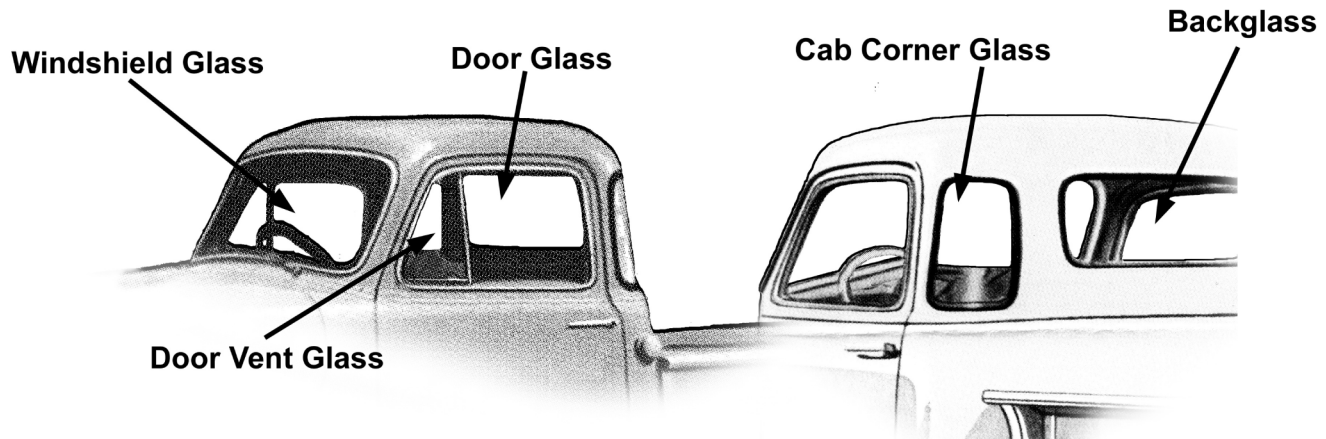
3807343.....47-55
Left, back door. Panel, Suburban (use with old casings). (16.400-15)
\$9.00 EA

Returns require a return authorization number, please call.

420T: Glass

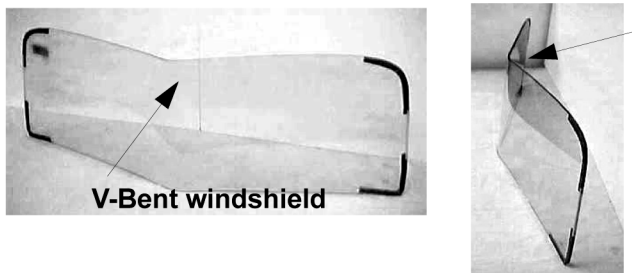


Format = Part No., Year, Description, original Chevrolet Part Book Group No., Price and Unit Measure.



Street Rod Parts

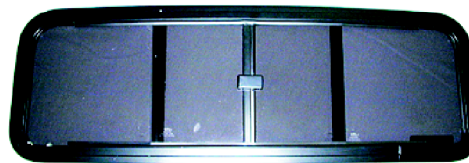
One Piece V-Bent Windshield Glass



Give your truck that clean, customized look with a one piece windshield. No more messy silicone sealing the center seam found on V-Butt windshields. All V-Bent windshields come with rubber seal.

1021V	39-46	Clear. Comes w/ rubber seal..... (-15)	\$400.00	EA
1021VSC	39-46	Clear w/ shaded top. Comes w/ rubber seal. (16.005-15).....	\$420.00	EA
1021VT	39-46	Tinted. Comes w/ rubber seal. (16.005-15)	\$410.00	EA
1021VS	39-46	Tinted w/ shaded top. Comes w/ rubber seal. (16.005-15).....	\$420.00	EA
4235V	47-53	Clear. Comes w/ rubber seal..... (16.005-15)	\$400.00	EA
4235VSC	47-53	Clear w/ shaded top. Comes w/ rubber seal. (10.027-15).....	\$420.00	EA
4235VT	47-53	Tinted. Comes w/ rubber seal. (10.027-15)	\$410.00	EA
4235VS	47-53	Tinted w/ shaded top. Comes w/ rubber seal. (10.027-15).....	\$420.00	EA

Back Glass & Frame



3704319C **47-54**
Slider, with snap closer (tinted). Black frame. (10.027-15)
\$166.75 EA

Restoration Parts

Windshield Glass

Note: Oversize shipping charges apply on all windshields. Please call for rate. Additional \$7 packaging fee each piece.

Note: Flat glass available for most cars and trucks, inquire for prices not listed. Prices are per side on 2-piece windshields. Order 2 (for left or right) for a complete 2-piece windshield. For V-Butt applications add \$3.00 per piece. Specify at time of order if V-Butting your windshield to remove center bar.

Note: Windshield glass dark tint unavailable. All glass is custom made. \$7 packaging fee.

985	37-38	Clear.....(16.005-15)....	\$98.50	EA
985T	37-38	Tinted.....(16.005-15)...	\$108.50	EA
985I	37-38	Clear, fits windshield frame part #602498B (See Sect. 430T).(Does not fit original.).....(16.005-15)...	\$108.50	EA
985S	37-38	Tinted with shaded top.....(16.005-15)...	\$136.00	EA
1021	39-46	Clear.....(16.005-15)....	\$62.75	EA
1021T	39-46	Tinted.....(16.005-15)....	\$69.00	EA
1021S	39-46	Tinted with shaded top.....(16.005-15)...	\$132.00	EA
4235S	47-53	Clear.....(10.027-15)....	\$78.00	EA
4235ST	47-53	Tinted.....(16.005-15)....	\$86.00	EA
4235SS	47-53	Tinted w/ shaded top.....(16.005-15)...	\$132.00	EA

420T

Providing part #'s speeds up your order, improves accuracy, and helps us maintain low prices.

See Illustration Index for core charge information and a list of abbreviations. For Body Model information, see 5T. 213



420T: Glass

Format = Part No., Year, Description, original Chevrolet Part Book Group No., Price and Unit Measure.

Windshield Glass

DW362	54	Curved (clear).....	(16.005-15)...	\$235.00	EA
DW362S	54	Tinted w/ shaded top	(16.005-15)...	\$219.00	EA

Note: Add 10% for green tint; 25% for gray tints. Door & windshield glass dark tint unavailable.

Door Glass

3907	37-38	(16.180-15)....	\$55.50	EA
4074	39-40	(16.180-15)....	\$67.50	EA
4084S	41-46	(16.180-15)....	\$57.50	EA
4236S	47-50	(16.180-15)....	\$67.50	EA
4236SLSC	47-50	Left side, clear w/ chrome frame.	(16.180-15)...	\$125.00	EA
4236SRSC	47-50	Right side, clear w/ chrome frame.	(16.180-15)...	\$125.00	EA
4377SLS	51-54	Left side w/ sash channel.	(16.180-15)....	\$85.00	EA
4377SRS	51-54	Right side w/ sash channel. .	(16.180-15)....	\$85.00	EA
4377S	51-54	(16.180-15)....	\$53.00	EA

Note: 1951-54 Door glass can be cut to eliminate the vent window. Call for price.

Door Vent Glass

2907S	51-54	(16.174-15)....	\$35.00	EA
-------	-------	-------	-----------------	---------	----

Back Glass

2690	37-38	(16.174-15)....	\$49.75	EA
2839	39-42	For cab w/ die cast frame	(16.174-15)....	\$60.75	EA
2651S	42-46	(16.174-15)....	\$60.75	EA
2720S	47-54	(16.174-15)....	\$68.25	EA

Rear Corner Cab Glass

Note: Rear corner cab glass can be chopped. Call for price and details.

BB60C	47-54	Clear (will not fit COE).....	(16.174-3)....	\$310.00	PR
BB60G	47-54	Gray (will not fit COE).....	(16.174-3)....	\$335.00	PR
BB60T	47-54	Tint (will not fit COE)	(16.174-3)....	\$310.00	PR

Suburban Front Side Glass

2719S	47-52	(16.174-15)....	\$39.25	EA
3007S	53-54	(17.136-15)....	\$41.75	EA

Suburban Rear Side Glass

4237S	47-52	(17.136-15)....	\$52.25	EA
4467S	53-54	(17.136-15)....	\$52.25	EA

Suburban Qtr Front Glass

4075	39-46	(17.136-15)....	\$73.50	EA
2721S	47-52	(17.136-15)....	\$41.75	EA
3008S	53-54	(17.136-15)....	\$41.75	EA

Suburban Qtr Rear Glass

4076	39-46	(17.136-15)...	\$73.50	EA
4238S	47-52	(17.136-15)...	\$57.50	EA
4466S	53-54	(17.136-15)...	\$57.50	EA

Suburban/ Panel Tailgate/ Door Back Glass

2689	37-38	(16.174-15)...	\$36.50	EA
2838	39-46	(16.174-2)	\$60.75	EA
DB60	47-54	Left, curved	(16.174-15) .	\$132.00	EA
DB61	47-54	Right, curved.....	(16.174-15) .	\$132.00	EA
BB59	47-54	Chevy/ GMC Suburban back glass (tempered)	(00.000-00)	CALL	

Odds & Ends

Please call for availability on all Odds & Ends parts; once part is sold, it may no longer be in stock.

BB60C..... 47-54

Left Corner Glass (Used) (-0)

\$75.00 EA

BB61C..... 47-54

Right Corner Glass (Used) (O&E-0)

\$75.00 EA

Returns require a return authorization number, please call.

430T: Windshield Rubber, Windshield Frames, Windshield Cranks & Related



Format = Part No., Year, Description, original Chevrolet Part Book Group No., Price and Unit Measure.

Windshield Divider



3651622 39-46
Rubber retainer w/
threaded steel core, no
moulding. (16.058-15)
\$55.00 SET

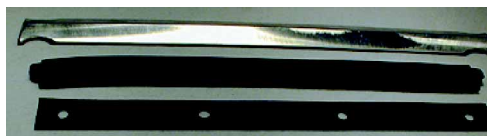
Windshield Moulding

3684807 47-53
Outside mouldings. Complete set.
Stainless Steel. (16.025-15)
\$80.00 SET

Moulding



3684697 47-53
Stainless windshield division trim. Interior.
(16.041-15)
\$54.50 EA



3676579 39-46
Exterior windshield, center aluminum w/ 3
pc rubber set. (16.018-15)
\$90.00 SET

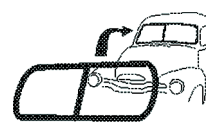
Windshield Frame Seal

3681322B 36-38
36 low roof cab, vulcanized. (16.017-3)
\$26.50 EA

3681322 39-46
Vulcanized. (16.042-3)
\$26.25 EA

Windshield Rubber

3684802A 47-53
W/out mouldings. 1 piece for V-Bent, V-
Butt. (O&E -15)
\$63.25 EA



3684695 47-53
For mouldings.
(16.042-15)
\$35.00 EA

3684802 47-53
W/out mouldings. (16.040-15)
\$35.00 EA

Windshield Rubber

3703534 54
For mouldings. (16.040-15)
\$32.00 EA

3703533 54
W/out mouldings. (16.040-15)
\$32.00 EA

Setting Tape



603954B 29-46
Windshield glass
(120in. length).
(16.040-2)
\$13.75 SET

Screw Set



3684481A 47-54
Windshield garnish
moulding (14 pcs).
(10.696-4)
\$3.50 SET

Windshield Crank



598909 39
W/ black knob
(16.040-15)
\$34.00 EA

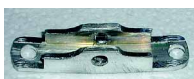


3654631A 40-46
W/ brown knob
(16.050-15)
\$34.00 EA

Strap Bracket



475838A 36-38
Windshield crank-out,
billet aluminum.
(16.050-15)
\$26.00 EA



3653708 39-46
Windshield crank-out,
billet aluminum.
(16.045-15)
\$26.00 EA

Grommet



598986 37-38
Grommet, windshield
crank to dash.
(16.045-15)
\$2.75 EA

Knob



598910A 39
Window or windshield
crank. Black.
(16.053-15)
\$9.00 EA



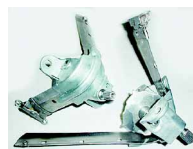
3654632B 40-46
Window or windshield
crank. Rose tan.
(16.270-15)
\$9.00 EA

Windshield Regulator

475838R 36-38
Rebuilt #CB-238 (\$100 core charge)
(16.045-15)
\$150.00 EA

598876R" 39
Rebuilt #CB-291 (\$100 core charge)",
(16.045-15)
\$150.00 EA

3654088R 40-46
Rebuilt #CB-301 (\$100 core charge)
(16.045-15)
\$150.00 EA



3654088 36-46
Rebuild service, casting
& metal tape must be
good, exchange.
(16.270-15)
\$118.50 EA

Windshield Rubber Bumper



3681093 37-46
(16.045-15)
\$7.00 PR

Windshield Frame



602132 36
Steel, low roof cab, special order (Super!)
(16.017-15)
\$334.00 EA

Providing part #'s speeds up your order, improves accuracy, and helps us maintain low prices.

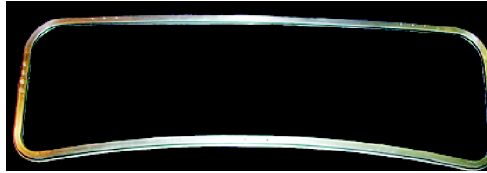
See Illustration Index for core charge information and a list of abbreviations. For Body Model information, see 5T. 215



430T: Windshield Rubber, Windshield Frames, Windshield Cranks & Related

Format = Part No., Year, Description, original Chevrolet Part Book Group No., Price and Unit Measure.

Windshield Frame

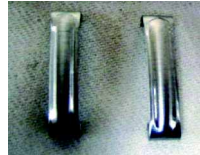


602498B **37-38**
Steel (Super!) (16.010-15)
\$334.00 EA



598972 **39-46**
Steel (Super!) (16.010-15)
\$360.00 EA

Trim Clip



602498A..... **37-38**
Windshield frame.
(16.010-15)
\$16.00 PR

Windshield Frame Connecting Inserts



592329 **39-46**
W/ stainless steel
screws. Holds frame
halves together.
(16.010-3)
\$25.00 SET

Odds & Ends

Please call for availability on all Odds & Ends parts; once part is sold, it may no longer be in stock.

3684809..... **47-53**

Moulding outer windshield w/
reinforcement (16.017-4)

\$50.00 EA

3684697U **47-53**

Moulding inside windshield division (Used)
(16.017-0)

\$150.00 EA

602132U **40**

Windshield frame (16.018-0)

\$200.00 EA

3684807U **47-53**

Windshield mouldings. Complete (Used)
(16.010-0)

\$150.00 L&R

Returns require a return authorization number, please call.

440T: Door Vent Window Rubber & Related



Format = Part No., Year, Description, original Chevrolet Part Book Group No., Price and Unit Measure.

Vent Window Assembly



3699713G 51-54
Left side assembly with glass. Set in chrome frame. (10.656-15)
\$88.50 EA



3699714G 51-54
Right side assembly with glass. Set in chrome frame. (16.173-15)
\$88.50 EA



3695655 51-55
Left. Black frame w/ vent window rubber and vertical seal with metal back. (no glass). (16.173-15)
\$126.00 EA



3695656 51-55
Right. Black frame w/ vent window rubber and vertical seal with metal back. (no glass). (16.173-15)
\$126.00 EA

Vent Window Handle



3695417L 51-54
Left. (16.173-15)
\$14.00 EA



3695416R 51-54
Right. (16.176-15)
\$14.00 EA

Vent Window Rubber



3696027 51-54
Original C shape w/ upper pivot pins, verticals w/ metal backs. (16.176-15)
\$38.00 PR

Pivot Pin



4173376..... 51-65
Vent window. Upper (16.175-4)
\$2.00 PR

Tool



4173376A..... 49-65
Sets vent window pivot pin. (10.669-15)
\$5.00 EA

Odds & Ends

Please call for availability on all Odds & Ends parts; once part is sold, it may no longer be in stock.

3657394N 41-53
Rear yoke of rear U-Joint, 3/4T. (13*000-0)
\$35.00 EA

596912 37-40
Torque tube U-Joint housing rear (13*000-0)
\$35.00 EA

7500 41-53
U-joint trunion bearing 3/4T Rear (13*000-0)
\$8.00 EA

17110 51-54
Vent Window Frame Pivot, Lower NORS (13*000-0)
\$25.00 PR

440T

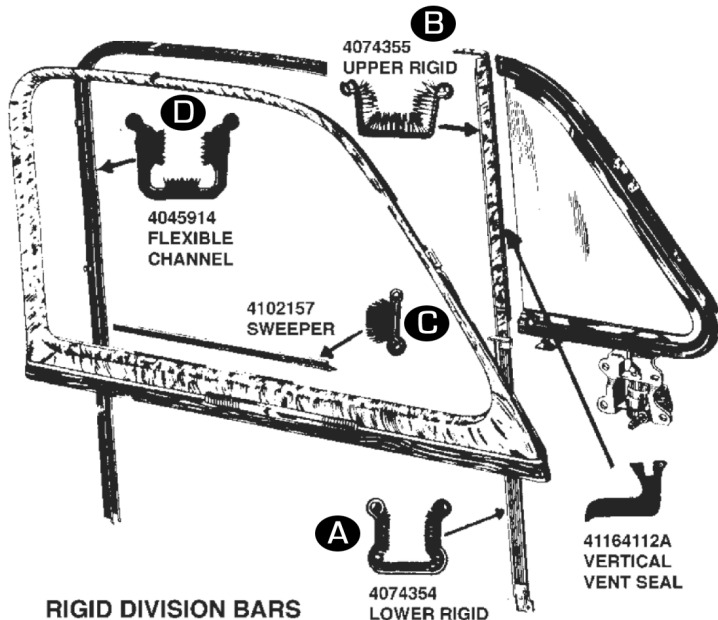
Providing part #'s speeds up your order, improves accuracy, and helps us maintain low prices.

See Illustration Index for core charge information and a list of abbreviations. For Body Model information, see 5T. 217

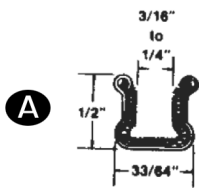


450T: Door Glass Channel Kits, Door Window & Related

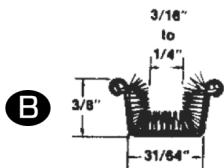
Format = Part No., Year, Description, original Chevrolet Part Book Group No., Price and Unit Measure.



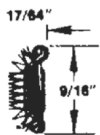
RIGID DIVISION BARS



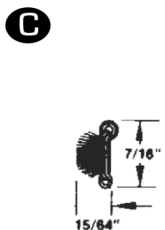
'40-'60 GM RIGID RUN CHANNEL SIDE WINDOW, LOWER, WITH STAINLESS STEEL BEAD
 4074354-72" PC. \$28.80 EA
 4074354-36" PC. \$14.40 EA



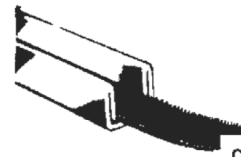
'33-'60 GM CARS RIGID DIVISION BAR WITH STAINLESS STEEL BEAD
 4074355-72" PC. \$28.80 EA
 4074355-36" PC. \$14.40 EA
 ACTUAL SIZE



FLEXIBLE SWEEPER G.M.C. TRUCKS '46-'49 LATE '50's GM CARS STAINLESS STEEL BEAD
 3684760-96" PC. \$38.40 EA
 3684760-64" PC. \$25.60 EA
 3684760-32" PC. \$12.80 EA



FLEXIBLE SWEEPER '33-'60 CHEV
 INNER & OUTER BELT-LINE. ALSO SLIDING QTR. WINDOWS. EASILY FORMED FOR QTR. WIND.
 STAINLESS STEEL BEAD
 4102157-64" PC. \$25.60 EA
 4102157-48" PC. \$19.20 EA
 4102157-32" PC. \$12.80 EA



CC 22 (1 5/8" WIDE) \$2.50 FT.

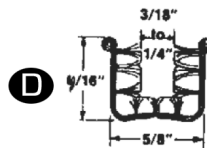
FOR RELINING PERMANENT GUIDE BARS ON A FEW CONVERTIBLES. BLACK MOHAIR LINING MATERIAL WITH RUBBERIZED BACKING TO BE CEMENTED IN PLACE.

For all Nomads & Wagons

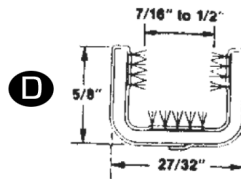
'46-'56 GLASS SETTING SEAL USED ON TL GATE ONLY.
 01C201PL \$2.75 FT.



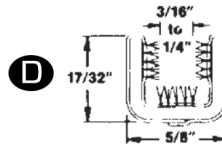
LOWER SIDE WINDOW CARRIER GLASS SETTING WITH WEATHER LIP FOR 5/8" CHANNEL DEPTH. '30-'40 CHEV. '46-'56 STATION WAGON
 01A201PL \$4.00 FT.



FLEXIBLE GLASS CHANNEL, MOHAIR LINED, CLOTH COVERED, STAINLESS STEEL BEADS. FITS '33-'60 GM SIDE WINDOWS.
 4045914-96" PC. \$48.00 EA
 4045914-60" PC. \$30.00 EA



FLEXIBLE GLASS CHANNEL, MOHAIR LINING. '50-'63 CHEV & GMC TRUCKS '41-'64 GM CARS. FOR WINDOWS WITH METAL FRAMES ONLY.
 3684434A-96" PC. \$49.92 EA
 3684434A-60" PC. \$31.20 EA



FLEXIBLE, UNBEADED PILE LINED. FITS '33-'62 CHEV & GMC PICKUPS & PANELS WITHOUT FRAMED SIDE GLASS.
 598746-96" PC. \$38.40 EA
 598746-60" PC. \$24.00 EA



2127 Parkerized

Door window reveal moulding fastener, corner: Chevrolet '41-'48 Special Deluxe Oldsmobile '41-'48, Model 60 Pontiac '41-'48, Models 25 and 27 \$3.00 EA

TO BE SLIPPED ON DOOR PANEL FASTENER STRIP FOR REPAIRS TO REPLACE BROKEN NAILS IN PANEL EDGING.



7/16" NAIL (.460)
 ALL GENERAL MOTORS
 "NAIL ON" DOOR PANEL REPAIR CLIPS
 WF18 \$1.50 (2 pcs)

Returns require a return authorization number, please call.

450T: Door Glass Channel Kits, Door Window & Related



Format = Part No., Year, Description, original Chevrolet Part Book Group No., Price and Unit Measure.

Window Shades



987203A.....51-54
Accessory. Stainless steel mounts over door glass. (32^000-15)
\$31.00 PR

Glass Channel Kit

Window Channel Kits: These are super complete and include sweepers, rigid channel, flexible channel, stops, screws, clips & rubber bumpers as needed. Complete for 2 doors.

598746B.....37-46
(16.200-2)

\$73.00 KIT

368443447-50
(16.200-15)

\$81.50 KIT

3699865B.....51-54
(16.200-3)

\$102.00 KIT

Note: 1937-1950 Channel Kits are oversized. Special shipping rates apply, please call for rate.

Window Wiper



3847051 36-46
Inner & outer rubber included in channel kit (4 piece) (-4)
\$13.50 SET



3847608 47-50
Outer (rubber included in channel kit). (16.183-4)
\$8.75 EA

3847608A.....51-54
Outer (rubber included in channel kit). (16.183-4)
\$7.75 SET

Division Bar

3695498A.....51-54
Rigid channel front of door glass. (08.800-2)
\$20.75 PR

Channel (Guide)



3721781A.....51-54
W/ brackets, lower rear of door glass. (16.175-2)
\$36.00 PR

Setting Tape Door Glass

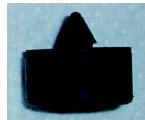


6039544037-40
Setting tape for 2 doors (120in. length). (16.190-2)
\$7.00 SET

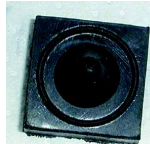
6039545041-50
Setting tape for 2 doors (168in. length). (10.696-2)
\$9.75 SET

6039545451-54
Setting tape for 2 doors (90in. length). (10.696-2)
\$5.25 SET

Window Stop Bumper



3681072..... 36-46
(10.696-15)
\$1.75 PR



4131052..... 47-54
(16.245-4)
\$3.50 PR

Screws & Sleeve Nuts



3694071..... 47-50
Attaches upper and lower door frame glass. (10.716-15)
\$5.00 SET

Adhesives



986199A ALL
3M Contact cement for rubber to metal. Bonds instantly. Industrial quality for gravel guards, running board rubber, etc. (16.183-15)
\$32.75 QT



511114..... ALL
Black weatherstrip cement, 5-oz tube. Superior product! (08.800-2)
\$7.50 EA



306105..... ALL
Krazy Glue. Rubber to metal & rubber to rubber bonding. Splice window gaskets & sponge weather strip & more. (08.800-15)
\$3.00 EA



GL14 ALL
Windshield sealer. Seals leaks in new & old installation. Will not dry out. (08.800-15)
\$6.00 EA

Odds & Ends

Please call for availability on all Odds & Ends parts; once part is sold, it may no longer be in stock.

3657495U..... 41-46
Frame Door Window Glass (16.190-0)
\$50.00 EA

3684847 47-53
Reveal door mouldings, left (Used) (32^000-0)
\$75.00 EA

3809865 47-50
Window channel retainer, left rear (16.181-0)
\$15.00 EA

450T

Providing part #'s speeds up your order, improves accuracy, and helps us maintain low prices.

See Illustration Index for core charge information and a list of abbreviations. For Body Model information, see 5T. 219



460T: Window Crank, Window Regulator & Power Window Kits

Format = Part No., Year, Description, original Chevrolet Part Book Group No., Price and Unit Measure.

Street Rod Parts

Power Window Conversion Gear Driven Bolt In

These kits directly bolt into original mounting holes. 1018 cold rolled steel, brass oilite thrust bearings, Delco OEM Motors and gear teeth cryogenically treated for long life. Includes Delco OEM Chrome or Illuminated switches and conduit for wiring. Comes with a lifetime warranty.

3684175 36-46
Complete kit; specify chrome or black switches. (16.180-15)

\$465.00 EA

3684176 47-50
Complete kit; specify chrome or black switches. (16.180-15)

\$465.00 EA

3684177 51-54
Complete kit; specify chrome or black switches. (16.180-0)

\$420.00 EA

Power Window Conversion Cable Driven

Super complete Bolt In kit. Bolts into existing holes, no new holes to drill. Kit comes complete with two cable drive regulators. Uses heavy duty OEM style motors.



3684163 36-46
(-15)

\$360.00 EA

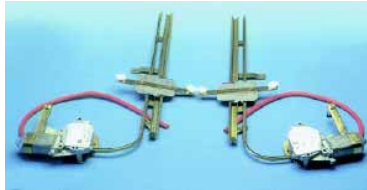
3684164A 47-50
(16.800-15)

\$360.00 SET

3684164 51-54
W/ vent window. (16.180-15)

\$360.00 SET

Power Window Conversion



477024 37-46

Complete kit for 2 doors. Requires some modification to fit. (16.180-15)

\$433.25 SET

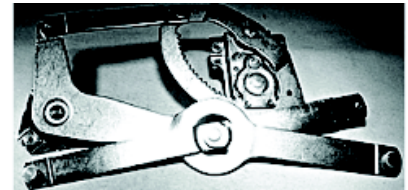
Restoration Parts

Window Regulator

594280N 34-46

Complete with arms. Right side (NOS). (10.783-2)

\$105.00 EA



3676433 47-50

Complete with arms. Left. (16.260-15)

\$77.50 EA

3676434 47-50

Complete with arms. Right. (16.260-15)

\$77.50 EA

3695321U 51-54

Complete with arms. Left side (Used). (16.260-15)

\$70.00 EA

3695322N 51-54

Complete with arms. Right side (NOS). (16.260-2)

\$105.00 EA

3695521 51-54

Complete w/ Arms (Left). (16.260-15)

\$85.00 EA

3695522 51-54

Complete w/ Arms (Right). (16.260-15)

\$85.00 EA



3695521A 47-54

Spring. (16.260-15)

\$4.50 EA

Knob



598910A 39

Window or windshield crank. Black. (16.260-15)

\$9.00 EA



3654632B 40-46

Window or windshield crank. Rose tan. (16.270-15)

\$9.00 EA

Returns require a return authorization number, please call.

460T: Window Crank, Window Regulator & Power Window Kits



Format = Part No., Year, Description, original Chevrolet Part Book Group No., Price and Unit Measure.

Knob



3683723A 47-50
Window crank, chrome.
(16.270-15)
\$9.00 EA



3702614D 51-53
Window crank, maroon.
(16.270-15)
\$9.00 EA



3702164A 54-57
Window crank, black.
(16.270-3)
\$9.00 EA

Window Crank



598910 39
With black knob.
(16.270-15)
\$30.00 EA



3654632A 40-46
With rose tan knob.
(16.270-15)
\$30.00 EA



3702164B 47-60
W/ replacement black knob. (16.270-3)
\$12.00 EA



3683723 47-50
W/ chrome knob.
(16.270-3)
\$28.50 EA



3699345 51-53
W/ maroon knob.
(16.270-2)
\$25.00 EA



3702164 54-57
W/ black knob.
(16.270-3)
\$16.00 EA

Odds & Ends

Please call for availability on all Odds & Ends parts; once part is sold, it may no longer be in stock.

3676433U 47-50
Regulator, Door Window Left (Used)
(32*000-0)
\$65.00 EA.

Odds & Ends

3676433N 47-50
Regulator NOS Left (32*000-0)
\$100.00 EA
594280U 36-46
Regulator, door glass, right (32*000-0)
\$65.00 EA
3702164BU 47-60
Window crank (Used) (32*000-0)
\$6.00 EA
3654632U 39-46
Window crank w/ ivory knob (Used)
(16.200-0)
\$15.00 EA
598800U 41-46
Windshield pillar covers (Used) (16.270-0)
\$15.00 PR



1953 1/2 Ton 3100—Curt Harrison, OR

460T

Providing part #'s speeds up your order, improves accuracy, and helps us maintain low prices.

See Illustration Index for core charge information and a list of abbreviations. For Body Model information, see 5T. 221



470T: Suburban Quarter Window Rubber & Related

Format = Part No., Year, Description, original Chevrolet Part Book Group No., Price and Unit Measure.

Rectangular Retaining Rubber



4070069 **47-54**
For quarter window,
Suburban (does two
windows) (16.563-0)
\$46.00 PR

Channel Kit

4070069C **47-54**
W/ quarter window rubber (#4070069). Fits
Suburban. Complete for two windows
(17.136-15)
\$99.00 SET



1947 Suburban—Don Bryant, California

I am so glad as I was trying to get to the proper page in your catalog I came across the photo of your friend, Freddie Pooler's woodie suburban. Obviously, I haven't "pawed" through the entire catalog, I start with the index and go directly to the page I need. Just when I thought I knew almost all there is to know about Chev woodie suburbans, his pops up! And as luck would have it, you know him! As you can see from my photos, our respective 'burbs are very different. Mine has the wood body (restored by Ron Heiden, who has his shop 25 miles north of San Diego in Encinitas) originally done by The Campbell Company out of New York. The other main woodie suburbans were made by a firm named The Cantrell Company. Both are 4 door, with a Cantrell having its front door about 4 to 6 inches wider than my Campbell, so the Cantrell's rear doors are cut out to go around the rear wheel wells, as opposed to my rear doors that you can see are just straight. The other way to tell the difference between the 2 models is the Cantrells have 3 hinges on the rear doors, and my Campbell has only 2 hinges. Of course the easiest difference is the cut out wheel well or not. I know of a 3 door 53 GMC Campbell. It has 3 doors only as the rear driver's side "non door" has the gas tank filler coming through the middle of the panel. It is owned by Don Gilbert who lives in Arizona, and I believe sells suburban parts also. I know of about 4 other Cantrell suburbans (I am a card carrying member of the National Woodie Club), and other than Gilbert's, I do not know of any other Campbell bodied 'burbs. My other strange feature is that my gas fill opening is under the left rear jumpseat, has a small trap door to get to the opening, kinda one of a kind. Do you know if Freddie is a member of the NWC? I will look through the roster tonight. I would very much like to talk/email him and learn more about his woodie. This might be more than you ever thought you might learn about wooden suburbans, one I get started, the info just flows out. I am very pleased to make this connection with you, and I would be very happy to have my Campbell gracing a page in your next catalog, as I have a number of parts from you. I will call you tomorrow about the fan belt that started all this. Here are my 3 favorite shots I took Thanksgiving morning in a cemetery near my home in Oakland, perhaps a strange venue, but I like the results. Best regards, Don

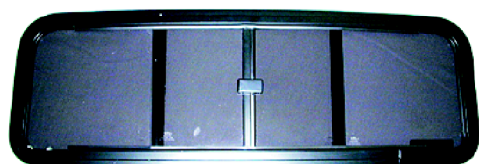
Returns require a return authorization number, please call.

480T: Rear Window Rubber & Sliding Back Glass



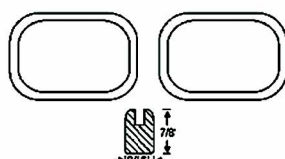
Format = Part No., Year, Description, original Chevrolet Part Book Group No., Price and Unit Measure.

Back Glass & Frame

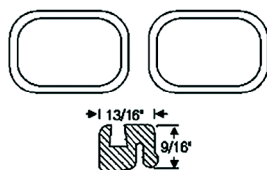


3704319C.....**47-54**
Slider, with snap closer (tinted). Black frame. (17.136-15)
\$166.75 EA

Back Glass Rubber

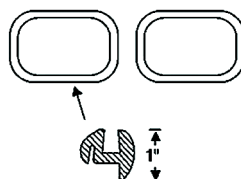


463535.....**34-38**
Panel & Suburban, vulcanized (16.464-15)
\$77.75 PR



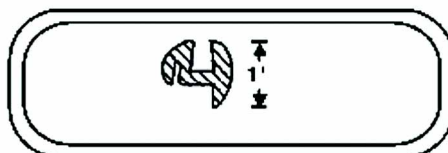
3806252.....**39-46**
Panel & Suburban, vulcanized (16.470-15)
\$77.75 PR

3807535A.....**47-57**
Panel & Suburban w/ doors (16.470-2)
\$34.00 PR



3807535.....**47-57**
Panel & Suburban w/ doors, vulcanized (16.470-15)
\$77.75 PR

Back Glass Rubber



3807917.....**47-54**
Panel & Suburban w/ end gate, vulcanized (16.470-15)
\$70.25 EA



3847421.....**36-38**
Low roof cab, vulcanized (16.470-15)
\$70.25 EA

599701.....**36-42**
For die cast frame (16.470-3)
\$26.75 EA

3847420.....**39-42**
Vulcanized, for die cast frame (16.470-4)
\$30.75 EA

3847419.....**42-46**
With lock strip (16.470-4)
\$18.75 SET

3847418.....**42-46**
W/ chrome lock strip (16.470-3)
\$18.75 SET

3847417.....**47-54**
W/ lock strip (16.470-3)
\$15.00 SET

3847416.....**47-54**
W/ chrome lock strip (16.470-2)
\$15.00 SET

Screw Set



3667020B..... **37-41**
Back glass frame (16.470-15)
\$6.25 SET

Rear Corner Glass Rubber



3847415.....**47-54**
W/ lock strip (16.475-3)
\$15.00 PR

Rear Corner Glass Rubber



3847414.....**47-54**
W/ chrome lock strip (16.470-2)
\$15.00 PR

Chrome Lock Strip



3847415A..... **42-54**
Back glass (7 ft) (16.470-4)
\$12.00 EA

3847415B..... **47-54**
Corner glass (8ft.-6in.) (16.469-4)
\$12.00 PR

Tool



3847415T..... **42-54**
Inserts back glass rubber lock strip. (16.469-15)
\$23.50 EA

Providing part #'s speeds up your order, improves accuracy, and helps us maintain low prices.

See Illustration Index for core charge information and a list of abbreviations. For Body Model information, see 5T. 223



490T: Complete Bed & Bed Parts—Bed Order Form

Format = Part No., Year, Description, original Chevrolet Part Book Group No., Price and Unit Measure.

Qty	Year	1/2 Ton or 3/4 Ton	Amount	
Pcs./Sets	19 ____	Description	Unit Price	Total \$
		Complete bed (1/2T) unassembled		
		Complete bed (3/4T) unassembled		
		Complete bed (1/2T) assembled		
		Complete bed (3/4T) assembled		
		Choices:		
		Stake pockets on bedside top flange:		
		with open stake pockets	N/C	
		with closed stake pockets	N/C	
		Tailgate:		
		with script	N/C	
		without script	N/C	
		Upgrades:		
		Welded stake pockets and corner strips to side panels (1/2T) upgrade for unassembled bed kits		
		Welded stake pockets and corner strips to side panels (3/4T) upgrade for unassembled bed kits		
		Tailgate chains—Upgrade to stainless		
		Bed strips—Unpolished stainless steel 1/2T		
		Bed strips—Unpolished stainless steel 3/4T		
		Bed strips—Aluminum with hidden fastener 1/2T (Upgrade for unassembled bed kit 1941–55 only)		
		Bed strips—Aluminum with hidden fastener 3/4T (Upgrade for unassembled bed kit 1941–55 only)		
		Holes prepunched in bed and corner strips 1/2T (Upgrade for unassembled bed kits)		
		Holes prepunched in bed and corner strips 3/4T (Upgrade for unassembled bed kits)		
		Bed to frame hold down bolt kit		
		Special handling/Crate fee/Skid		
			Total \$:	
Ship to:				
Name:			Home phone:	
Street:			Work phone:	
City:	State:	Zip:	Email address:	

Returns require a return authorization number, please call.

490T: Complete Bed & Bed Parts



Format = Part No., Year, Description, original Chevrolet Part Book Group No., Price and Unit Measure.

Street Rod Parts

Fuel Filler Concealment Kit



LHRSCK **ALL**
 Hide your fill neck in the bed. Motor lifts a bed wood panel for easy access. All stainless & aluminum hardware, hinges, motor & switch included. (16.469-0)
\$525.00 EA

Pros Pick Custom Bed - Chevy

FABRICATED FROM 16 GAUGE, SATIN COATED STEEL (SIMILAR TO GALVANIZED) • Plug welded construction (no unsightly spot welds). • Epoxy primed so you can block sand and paint. • Includes 2 sides, closed stake pockets, front panel and all cross members. *TAILGATE, BED STRIPS AND WOOD NOT INCLUDED.



25230100 **30-36**
 Standard bed size and height. (20.000-0)
\$1,475.00 KIT

25237100 **37-39**
 Standard bed size and height. (20.000-0)
\$1,475.00 KIT

24240100 **40-46**
 Standard bed size and height. (20.000-0)
\$1,475.00 KIT

25247100 **47-53**
 Standard bed size and height. (20.000-15)
\$1,475.00 KIT

Pros Pick Custom Bed - Chevy

25247T100 **47-53**
 3 inch taller height than standard. (20.000-15)
\$1,620.00 KIT

25254100 **54-55**
 Standard bed size and height. Fits 1st Series. (20.000-0)
\$1,620.00 KIT

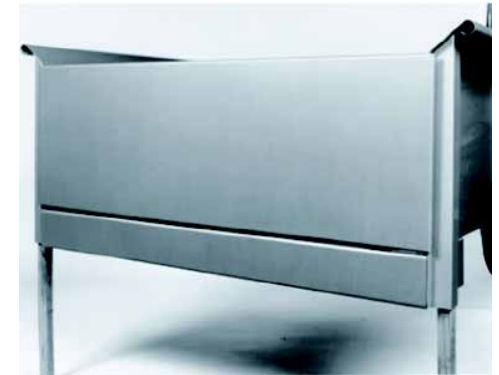
Pros Pick Custom Roll Pan - Chevy



23247100 **47-53**
 Bolt-on, smooth. 1-piece, 12ga. steel. Recess for license plate. Use with Pro's Pick tailgate only (order 4-piece roll pan for stock tailgates). (20-0)
\$450.00 EA

Tailgate - Custom

Stock tailgates have exposed hinges that leak rusty water, chains that damage expensive paint and unsightly, poorly designed latches. Pro's Pick changed all that; • Tailgates manufactured from 16 gauge, satin coated steel. • Hidden hinges concealed into the rear cross member. • Hidden latch assemblies actuated by 2 small knobs on the inside of the tailgate. • Nylon latch bolts and stainless steel strikers assure smooth, quiet and rust free operation. • Mounts to Pro's Pick Custom Beds as well as Stock Beds to add a clean custom look to your original bed.



TAILGATEPRO **46-87**
 Smooth, clean finish. Upgrade to complete Pro's Pick Bed only. (-15)
\$850.00 EA

TAILGATEPROW **46-87**
 Smooth, clean finish. (-0)
\$930.00 EA

Tailgate

3801850L **41-46**
 Complete w/ louvers (7 rows w/ 6 louvers each row) (also GMC) (-15)
\$210.00 EA

3806856L **47-53**
 Complete w/ louvers (7 rows w/ 6 louvers each row) (also GMC) (17.615-15)
\$210.00 EA

3810424B **54-57**
 49 louvers. Complete (also fits GMC). (17.615-15)
\$200.00 EA

490T

Providing part #'s speeds up your order, improves accuracy, and helps us maintain low prices.

See Illustration Index for core charge information and a list of abbreviations. For Body Model information, see 5T. 225



490T: Complete Bed & Bed Parts

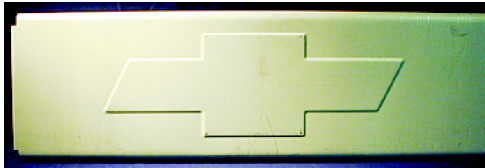
Format = Part No., Year, Description, original Chevrolet Part Book Group No., Price and Unit Measure.

Tailgate Cover

3801850D **41-46**
Cover, hides the dents, smooth (also GMC)
(17.615-15)
\$50.00 EA



3806856J **47-53**
Cover, hides the dents. 4 rows of louvers
(also fits GMC). (17.615-15)
\$60.00 EA



3806856M **47-53**
Cover w/ bowtie. (17.615-15)
\$80.00 EA

810424C **54-57**
Cover, hides the dents. 7 rows of louvers.
(17.615-15)
\$65.00 EA



3806856M **54-87**
31-1/2" x 10". Skin w/ bowtie (17.615-15)
\$80.00 EA

Tailgate - Hidden Latch

Stock tailgates are "beautiful," they hold the classic look that is near and dear to all enthusiasts. They also carry those tailgate chains that ruin our \$10,000 paint jobs. When Pros Pick designed this kit they felt the criteria had to be: • Anyone could handle the installation. • The tailgate had to slam shut. • No rattles allowed as you drive down the road. • None of the materials used could ever rust. • It had to have check straps that could not damage the paint. • You could install it on a painted bed without damaging the paint job. • It had to look cool, yet be compatible with the vintage look of the truck. • A touch of the release buttons on each side allow the gate to open.

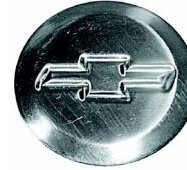


26300016 **ALL**
Latch kit with 16 inch straps. (-15)
\$185.00 SET



26300021 **ALL**
Latch kit with 21 inch straps. (-15)
\$185.00 SET

Billet Caps



3806518B **41-55**
1-3/4in. polished aluminum w/ bowtie, covers hole top rear of bedside. (-15)
\$35.00 PR



3806518C **41-55**
1-3/4in. satin aluminum, covers hole top rear of bedside. (17.505-15)
\$24.00 PR

Returns require a return authorization number, please call.

490T: Complete Bed & Bed Parts



Format = Part No., Year, Description, original Chevrolet Part Book Group No., Price and Unit Measure.

Restoration Parts

Complete beds include: Front Bed Panel, Bed Side Panels, Stake Pockets, Oak Bed Wood, Steel Bed & Corner Strips, Bed Wood Bolt Kit, Cross Sills, Tailgate, Tailgate Hinges & Tailgate Chain.

Note: Complete Beds are sent Freight Collect. \$75 Crate charge per Complete Bed. (Specify with or without stake pockets holes and fender bolt holes.)

Note: Stainless Corner Strips are difficult to weld and are not recommended by manufacturing company.

Complete Bed - Assembled



3690611	37-53	1/2T assembled (specify year when ordering) (00.000-0)\$1,650.00EA
369061155	54-55	1/2T assembled..... (20.000-15)\$2,161.00EA
3690611B	37-53	3/4T assembled (specify year when ordering) (00.000-15)\$1,850.00EA
3690611B55	54-55	3/4T assembled..... (20.000-15)\$2,494.00EA

Complete Bed - Unassembled

3690610	37-53	1/2T unassembled (specify year when ordering) . (-15)\$1,399.00EA
369061055	54-55	1/2T unassembled..... (20.000-15)\$1,910.00EA
3690610B	37-53	3/4T unassembled (specify year when ordering) . (00.000-15)\$1,470.00EA
3690610B55	54-55	3/4T unassembled..... (20.000-15)\$2,243.00EA

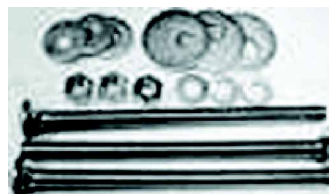
Complete Bed Upgrade

The following items are available as upgrades for the Complete Bed Kits.

3690610W	37-54	Brackets, weld stake pockets & angle strips to side panels (1/2T), an upgrade for unassembled bed kits (-0)\$95.00SET
3690610BW	37-54	Brackets, weld stake pockets & angle strips to side panel (3/4T), an upgrade for unassembled bed kits (17.438-15)\$114.50SET
3690600H	37-54	Stake pocket holes in top flange of bed side. (17.438-0)\$0.00
3690600NH	37-54	No stake pocket holes in top flange of bed side. (17.438-0)\$0.00EA

Complete Bed Upgrade

3801845SU	32-53	Tailgate chains, upgrade to stainless(17.462-15) \$38.50PR
3810823SU	54-60	Tailgate chains, upgrade to stainless(17.635-15) \$40.00PR
3690609S	37-54	Strips, unpolished stainless steel, w/ polished bolt heads, 1/2T(17.635-15)\$119.00SET
3690609BS	37-54	Strips, unpolished stainless steel, w/ polished bolt heads, 3/4T(17.438-3)\$126.00SET
384734S	39-54	Strips, aluminum with hidden fasteners, 1/2T (17.438-15)\$180.00SET
384734BS	37-59	Strips, aluminum with hidden fasteners, 3/4T (17.438-4)\$245.00SET
3690610P	37-54	Holes pre-punched w/ bed strips & corner strips, 1/2T.(17.438-15)\$24.00EA
3690610BP	37-54	Holes pre-punched w/ bed strips & corner strips, 3/4T.(17.438-15)\$34.00EA



3690601	37-55	Bed to frame bolt kit, steel, 1/2T (17.438-0)..... \$24.00 SET
3690602S	37-55	Bed to frame bolt kit, stainless steel, unpolished, 1/2T (17.447-0)..... \$34.00 SET
3690603P	37-55	Bed to frame bolt kit, stainless steel polished head, 1/2T (17.447-0)..... \$46.00 SET
3690607A	37-55	Bed to frame bolt kit zinc used with Aluminum bed strips 1/2T (17.447-0)..... \$27.00 SET
3690604	37-55	Bed to frame bolt kit, steel, 3/4T (17.447-0)..... \$24.00 SET
3690605S	37-55	Bed to frame bolt kit, stainless steel, unpolished, 3/4T (17.447-0)..... \$34.00 SET
3690606P	37-55	Bed to frame bolt kit, stainless steel polished head, 3/4T (17.447-0)..... \$46.00 SET
3690608A	37-55	Bed to frame bolt kit zinc used with Aluminum bed strips 3/4T (17.447-0)..... \$29.00 EA

Note: Bed to frame bolt kits are only available with complete bed kits.

Note: All our Stainless bolt kits are all Stainless!!

Providing part #'s speeds up your order, improves accuracy, and helps us maintain low prices.

See Illustration Index for core charge information and a list of abbreviations. For Body Model information, see 5T. 227



490T: Complete Bed & Bed Parts

Format = Part No., Year, Description, original Chevrolet Part Book Group No., Price and Unit Measure.

Front Bed Panel



463673	34-40	W/out hardware, 1/2T& 37-39 3/4 & 1T 45, 3/4in. wide..... (20.455-15) ... \$160.00	EA
3800261T45	40-45	W/ hardware, 48-1/2in. wide (for 5 bed strips) (20.455-15) ... \$100.00	EA
3800261T46	46	W/ hardware, 48-1/2in. wide (for 6 bed strips) (20.455-15) ... \$100.00	EA
3810042	47-53	W/ hardware, 50in. wide (1/2T & 3/4T) (20.455-15) ... \$100.00	EA
3810042T50	47-50	W/ hardware (1T) (20.455-15) ... \$135.00	EA
3810042T53	51-53	W/ hardware (1T) (20.455-15) ... \$135.00	EA
3810404	54	W/ hardware..... (20.455-15) ... \$100.00	EA

Note: Oversize shipping charges apply on all Front Bed Panels. Please call for rates.

Bed Side Panel

Note: Bed Side Panels are sent Freight Collect. \$75 Crate charge per pair. (Specify with or without stake pockets holes.)

46642339	37-39	1/2T w/ stake pocket & bed corner strip, left..... (-0) \$320.00	EA
46642439	37-39	1/2T w/ stake pocket & bed corner strip, right (20.455-0) \$320.00	EA
46642340	40	1/2T w/ stake pocket & bed corner strip, left..... (20.455-0) \$320.00	EA
46642440	40	1/2T w/ stake pocket & bed corner strip, right (20.455-0) \$320.00	EA
380685746	41-46	1/2T w/ stake pocket & bed corner strip, left..... (20.455-15) ... \$310.00	EA
380685846	41-46	1/2T w/ stake pocket & bed corner strip, right (20.455-15) ... \$310.00	EA
380685753	47-53	1/2T w/ stake pocket & bed corner strip, left..... (17.505-15) ... \$295.00	EA
380685853	47-53	1/2T w/ stake pocket & bed corner strip, right (17.505-15) ... \$295.00	EA
380651753	41-53	3/4T w/ stake pocket & bed corner strips, left..... (17.505-15) ... \$415.00	EA
380651853	41-53	3/4T w/ stake pocket & bed corner strips, right..... (20.455-15) ... \$415.00	EA
381042954	54	1/2T w/ stake pocket & bed corner strips, left..... (20.455-15) ... \$370.00	EA
381043054	54	1/2T w/ stake pocket & bed corner strips, right..... (20.455-15) ... \$370.00	EA
381251354	54	3/4T w/ stake pocket & bed corner strips, left..... (17.615-15) ... \$495.00	EA

Bed Side Panel

381251454	54	3/4T w/ stake pocket & bed corner strips, right (17.505-15) \$495.00	EA
-----------	----	---	----

Stake Pockets



466423F	34-38	Front..... (17.505-15)..... \$40.00	EA
466423L	34-38	Left rear..... (17.462-15)..... \$40.00	EA
466424R	34-38	Right rear (17.462-15)..... \$40.00	EA
3806857F	39-53	Front (left or right) (17.462-15)..... \$40.00	EA
3806857L	39-53	Left rear..... (17.462-15)..... \$40.00	EA
3806858R	39-53	Right rear (17.462-15)..... \$40.00	EA
3810428F	54-59	Front (left or right). (17.462-15)..... \$58.50	EA
3810429L	54-59	Left rear..... (17.462-15)..... \$60.00	EA
3810430R	54-59	Right rear (17.462-15)..... \$60.00	EA

Bed Strips

3847634	ALL	Short (78in.), steel, 1/2T, no holes (17.462-15)..... \$5.00	EA
3847634S	ALL	Short (78in.), stainless, 1/2T, no holes (17.438-15)..... \$11.00	EA
3847634SP	ALL	Short (78in.), polished stainless, 1/2T, no holes (17.438-15)..... \$17.00	EA
3847634P	37-59	Short (74in.-78in.) w/ pre-punched square holes. steel, 1/2T, specify year when ordering (17.438-2)..... \$8.00	EA
3847634X	37-59	Short (74in.-78in.) w/ pre-punched square holes. stainless steel, 1/2T, specify year when ordering (20.438-0)..... \$14.00	EA
3847634Y	37-59	Short (74in.-78in.) w/ pre-punched square holes. polished stainless, 1/2T, specify year when ordering (17.438-15)..... \$20.00	EA
3847634A	37-59	Short (74in.-78in.) aluminum w/ hidden fastener bolts for hidden fastening included, specify year when ordering (17.438-15)..... \$35.00	EA
3847635	ALL	Long (96in.), steel, no holes..... (17.438-15)..... \$6.00	EA
3847635S	ALL	Long (79in.-96in.), stainless, no holes (17.438-2)..... \$19.50	EA
3847635SP	ALL	Long (79in.-96in.), polished stainless, no holes (17.438-15)..... \$19.50	EA
3847635P	37-59	Long (79in.-96in.), w/ pre-punched square holes. steel, specify year when ordering (17.438-15)..... \$9.50	EA
3847635X	37-59	Long (79in.-96in.), w/ pre-punched square holes. stainless, specify year when ordering (17.438-0)..... \$16.50	EA

Returns require a return authorization number, please call.

490T: Complete Bed & Bed Parts



Format = Part No., Year, Description, original Chevrolet Part Book Group No., Price and Unit Measure.

Bed Strips

3847635Y	37-59	Long (79in.-96in.), w/ pre-punched square holes. polished stainless, specify year when ordering (17.438-15) \$24.50 EA
3847635A	37-59	Long (79in.-96in.), aluminum, w/ hidden fastener bolts for hidden fastening included, specify year when ordering (17.438-15) \$35.00 EA

Note: Bed Strips over 96 inches are available. Special order, call for price.

Note: Oversize shipping charges apply on Bed Strips. Call for rates. Bed Strips over 96 inches are sent freight collect.

Corner Strips

3810803	ALL	Short bed (78in.). Steel, 1/2T, no holes..... (17.438-3) \$27.50 EA
3810803S	ALL	Short bed (77-1/8in.). Stainless, 1/2T, no holes..... (17.438-15) \$40.00 EA
3810803P	37-59	Short bed (74in.-78in.) w/ pre-punched square holes. steel, 1/2T, specify year when ordering (17.438-0) \$30.00 PR
3810803X	37-59	Short bed (74in.-78in.) w/ pre-punched square holes. stainless, 1/2T, specify year when ordering (17.438-15) \$50.00 PR
3810803Y	37-59	Short bed (74in.-78in.), w/ pre-punched square holes. polished stainless, 1/2T, specify year when ordering (17.438-0) \$60.00 PR
3810804P	37-59	Long bed (74in.-78in.) w/ pre-punched square holes. steel, specify year when ordering (17.438-0) \$36.00 PR
3810804	ALL	Long bed (79in.-96in.). Steel, no holes (17.438-15) \$30.00 EA
3810804T	ALL	Long bed (79in.-96in.), stainless steel, no holes..... (17.438-15) \$46.00 SET
3847637SP	ALL	Long bed (79in.-96in.), polished stainless steel, no holes..... (17.438-15) \$56.00 PR
3810804X	37-59	Long bed (79in.-96in.) w/ pre-punched square holes. stainless, specify year when ordering (17.438-3) \$56.00 PR
3847636Y	37-59	Long bed (79in.-96in.) w/ pre-punched square holes. polished stainless, specify year when ordering (17.438-0) \$74.00 PR

Note: Corner Strips over 96 inches are available. Special order, call for price.

Note: Oversize shipping charges apply on Corner Strips. Call for rates. Corner Strips over 96 inches are sent freight collect.

Bed Wood

Note: Oversize shipping charges apply on all Bed Wood. Call for rates.

38474030	37-59
Oak, sized & grooved, 1/2T, specify year when ordering (-0)	
\$260.00 SET	
38474030H	40-59
Oak, sized & grooved, 1/2T, w/ mounting holes, specify year when ordering (20.438-0)	
\$348.00 SET	
38474040	37-59
Oak, sized & grooved, 3/4T, specify year when ordering (17.438-0)	
\$285.00 SET	
38474040H	40-59
Oak, sized & grooved, 3/4T, w/ mounting holes, specify year when ordering (17.438-0)	
\$380.00 SET	
38474050	37-39
Oak, sized & grooved, GMC long bed, specify year when ordering (17.438-0)	
\$350.00 EA	
38474050H	37-55
Oak, sized & grooved, GMC long bed with mounting holes, (specify year when ordering) (17.438-0)	
\$350.00 EA	
3847403P	37-59
Pine-sized & grooved, 1/2T (specify year when ordering) (17.438-0)	
\$185.00 SET	
3847403PH	40-59
Pine-sized & grooved, 1/2T w/ mounting holes (specify year when ordering) (17.438-0)	
\$215.00 SET	
3847405P	37-39
Pine, sized & grooved, GMC long bed, specify year when ordering (17.438-0)	
\$210.00 EA	
3847405PH	37-55
Pine, sized & grooved, GMC long bed w/ mounting holes, (specify year when ordering) (17.438-0)	
\$240.00 EA	
3847403PH59	54-59
Pine-sized & grooved, 1/2T w/ mounting holes (specify year when ordering) (17.438-15)	
\$248.75 SET	

Bed Wood Washer

458394W	ALL
Offset square hole, 1/2T (6 piece) (17.438-15)	
\$6.75 SET	

490T

Providing part #'s speeds up your order, improves accuracy, and helps us maintain low prices.

See Illustration Index for core charge information and a list of abbreviations. For Body Model information, see 5T. 229



490T: Complete Bed & Bed Parts

Format = Part No., Year, Description, original Chevrolet Part Book Group No., Price and Unit Measure.

Bed Wood Washer

458394WS **ALL**
Offset square hole, stainless steel, 1/2T (6 piece) (17.447-15)

\$10.50 SET

458395W **ALL**
Offset square hole, 3/4T (8 piece) (17.447-15)

\$9.00 SET

458395WS **ALL**
Offset square hole, stainless steel, 3/4T (8 piece) (17.447-15)

\$14.00 SET

Bed Wood, Bed Mount Bolts

458394 **ALL**
1/2T, zinc-plated, specify year when ordering (17.447-0)

\$33.75 SET

458394S **37-59**
Stainless steel, 1/2T (17.447-0)

\$64.75 SET

458394Z **37-59**
1/2T, polished (17.447-0)

\$86.25 SET

458393 **37-59**
3/4T & long bed, zinc-plated, specify year when ordering (17.447-0)

\$40.00 SET

458393S **37-59**
3/4T & long bed, stainless steel, specify year when ordering (17.447-0)

\$75.50 SET

458393Z **37-59**
3/4T & long bed, polished, specify year when ordering (17.447-0)

\$94.00 SET

Bed Mounting Blocks



458394G **36-46**
& pads, cypress, 1/2T (17.447-15)

\$17.00 SET

458394J **37-46**
& pads, cypress, 3/4T (17.447-15)

\$20.50 SET

Bed Mounting Blocks

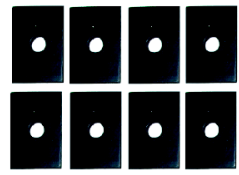
458394D **47-53**
& pads, cypress, 1/2T (17.447-15)

\$12.25 SET

458394E **47-53**
& pads, cypress, 3/4T (17.447-15)

\$15.50 SET

Bed Mounting Rubber Pads



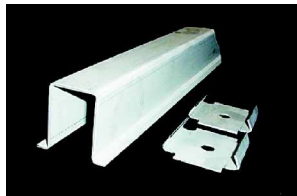
458394F **54-59**
1/2T (17.447-0)

\$4.50 SET

458394H **54-59**
Long bed & 3/4T (17.447-0)

\$5.50 SET

Small Crossmember



3860566 **37-57**
Front or center comes with flange brackets (specify year when ordering) (17.447-0)

\$23.50 EA

Rear Crossmember



3810032 **ALL**
1/2T, no holes (specify year when ordering) (17.405-0)

\$95.00 EA

3806578 **47-53**
3/4T, no holes (17.405-15)

\$90.00 EA



3713954 **54-55**
3/4T, no holes (55 1st series) (17.405-15)

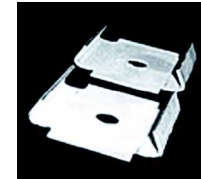
\$90.00 EA

Rear Crossmember

3806581 **47-53**
1T, no holes (17.405-15)

\$90.00 EA

Flange Bracket

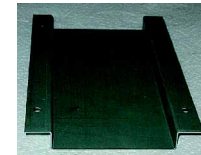


3860566A **37-53**
Crossmember

(17.405-3)

\$6.00 EA

Tailpipe Heat Shield



3689481R **37-46**
Under bed. (20.405-15)

\$6.75 EA

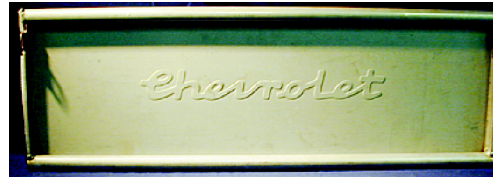


3689481S **47-54**
Under bed. (03.706-15)

\$7.00 EA

Tailgate

Note: Oversize shipping charges apply. Please call for rates.



471196A **34-39**
Chevrolet script, complete, original 1939

(-15)

\$250.00 EA



471196 **34-39**
Complete w/out script, also GMC, original 1934-38. (17.615-15)

\$250.00 EA

Returns require a return authorization number, please call.

490T: Complete Bed & Bed Parts



Format = Part No., Year, Description, original Chevrolet Part Book Group No., Price and Unit Measure.

Tailgate



- 3800262D**.....**40**
Chevrolet script, complete (17.615-15)
\$245.00 EA
- 3800262**.....**40**
Complete w/out script, also GMC
(17.615-15)
\$200.00 EA



- 3801850**.....**41-46**
Complete. Also fits GMC. Original
(17.615-15)
\$160.00 EA



- 3806856**.....**47-53**
Chevrolet script, complete (17.615-15)
\$210.00 EA

- 380685H**.....**47-53**
GMC script, complete (17.615-15)
\$210.00 EA



- 3806856B**.....**47-53**
Complete w/out script, also GMC
(17.615-15)
\$160.00 EA

Tailgate

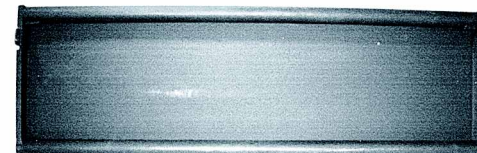


- 3810424**.....**54-57**
Chevrolet script, complete (17.615-15)
\$300.00 EA
- 3810424S**.....**54-57**
Bowtie, complete, flush fit (double wall)
(17.615-15)
\$220.00 EA
- 3810424G**.....**54-57**
GMC script, complete (17.615-15)
\$275.00 EA

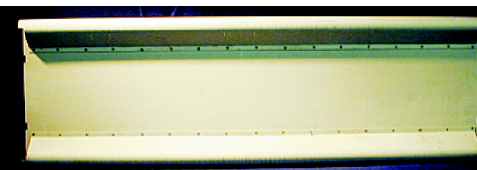


- 3810424H**.....**54-57**
GMC (has 47-53-style GMC script)
(17.615-0)
\$200.00 EA
- 3810424A**.....**54-57**
Complete w/out script, also GMC
(17.615-15)
\$160.00 EA

Tailgate Skin



- 3801850A**.....**41-46**
Skin, no script, also GMC (17.615-0)
\$117.00 EA



- 3806856C**.....**47-53**
Skin. No script. Also fits GMC. (17.615-15)
\$110.00 EA

Tailgate Decal



- 3800262B**.....**39-40**
Chevrolet script, chrome (17.615-15)
\$12.50 EA
- 3800262C**.....**39-40**
Chevrolet script, black (17.615-15)
\$9.00 EA
- 3800262A**.....**39-40**
Chevrolet script, white (17.615-15)
\$9.00 EA



- 3806856E**.....**47-53**
Chevrolet script, chrome (17.615-15)
\$9.00 EA
- 3806856F**.....**47-53**
Chevrolet script, black (17.615-15)
\$8.00 EA
- 3806856D**.....**47-53**
Chevrolet script, white (17.615-15)
\$8.00 EA
- 3810424F**.....**54-57**
Chevrolet script, chrome (17.615-15)
\$9.00 EA
- 3810424E**.....**54-57**
Chevrolet script, black (17.615-15)
\$8.00 EA



- 3810424D**.....**54-57**
Chevrolet script, white (17.615-15)
\$7.00 EA



- 3806856I**.....**47-53**
GMC script, chrome (17.615-15)
\$9.00 EA
- 3806856H**.....**47-53**
GMC script, black (17.615-15)
\$7.00 EA
- 3806856G**.....**47-53**
GMC script, white (17.615-15)
\$7.00 EA

490T

Providing part #'s speeds up your order, improves accuracy, and helps us maintain low prices.

See Illustration Index for core charge information and a list of abbreviations. For Body Model information, see 5T. 231



490T: Complete Bed & Bed Parts

Format = Part No., Year, Description, original Chevrolet Part Book Group No., Price and Unit Measure.

Tailgate Hinge



- 463671** **34-39**
(17.615-15)
\$25.25 EA
- 3806884A** **40**
With bushing (17.625-15)
\$28.50 EA
- 3806884** **41-53**
(17.625-2)
\$20.00 EA
- 3810706** **54-57**
Trunion & bolt (17.625-15)
\$25.00 PR

Bracket-Tailgate Chain



- 3801845C** **34-40**
Left (17.625-15)
\$15.25 EA



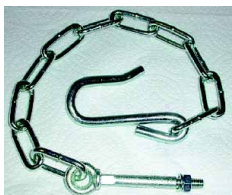
- 3801845B** **34-40**
Right (17.635-15)
\$15.25 EA

Eye Bolt



- 3801845D** **34-53**
Tailgate chain
(17.635-15)
\$10.25 EA

Tailgate Chains

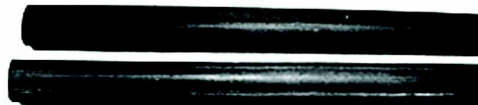


- 3801845J** **32-53**
Assembly, zinc plated (17.635-15)
\$25.00 PR

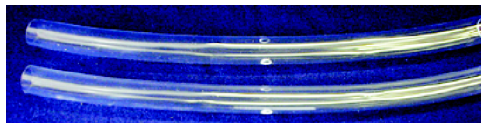
Tailgate Chains

- 3801845S** **32-53**
Assembly, stainless (17.635-15)
\$50.00 PR
- 3810823** **54-60**
Assembly, zinc plated (17.635-15)
\$25.00 PR
- 3810823S** **54-60**
Assembly, stainless (17.635-15)
\$50.00 PR

Tailgate Chain Covers



- 3810750** **32-60**
Black rubber (17.635-4)
\$9.00 SET



- 3810750C** **32-60**
Clear rubber (17.635-0)
\$5.00 PR

Spare Tire Carrier



- 358451** **41-50**
Assembly under bed (17.635-0)
\$289.50 SET

Odds & Ends

Please call for availability on all Odds & Ends parts; once part is sold, it may no longer be in stock.

- 3808817** **47-55**
Lock support - back door, fits panel and suburbans with back door (-0)
\$35.00 EA

Returns require a return authorization number, please call.

520T: Manuals, Accessory Books, Service Bulletins & Sales Brochures



Format = Part No., Year, Description, original Chevrolet Part Book Group No., Price and Unit Measure.

Owner's Manual

OWN T 37-55
Specify year when ordering (18.000-0)

\$8.75 EA

OWN G 37-55

GMC, specify year when ordering (18.000-0)

\$6.50 EA

Folder

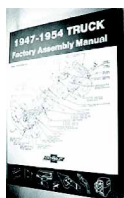


OWNFD ALL

For owners' manual & papers, Chevrolet Motor Division, original type (18.000-2)

\$3.00 EA

Assembly Manual

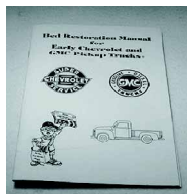


ASS47 47-54

This gives incredible detail a must have (original 54) (18.000-15)

\$30.00 EA

Bed Assembly

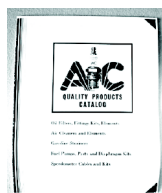


BED00 ALL

& restoration manual (18.100-15)

\$4.00 EA

AC Parts Catalog



PARTAC41 29-41

Oil, fuel & air filters, speedometer cables (18.000-4)

\$4.00 EA

Parts Book



PART42W 35-41

Woody wagon & Suburban (18.200-3)

\$10.00 EA

PART48W 42-48

Suburban (18.200-3)

\$10.00 EA

Parts Interchange

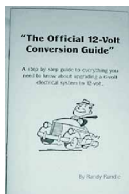


PART51N 29-52

Chev, Pontiac, Oldsmobile (18.200-15)

\$20.00 EA

12V Book

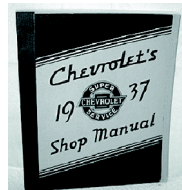


BOOK12V ALL

6v to 12v conversion (18.200-15)

\$10.00 EA

Shop Manual



SHOP37 37

Car & truck, full size. Superb! (19.500-15)

\$20.00 EA

SHOP37P 37

W/ car & truck, 3/4 size photocopy (18.300-15)

\$16.25 EA

SHOP38 38

W/ car & truck, full size. Superb! (18.300-15)

\$20.00 EA

SHOP38P 38

W/ car & truck, 3/4 size photocopy (18.300-15)

\$12.00 EA

SHOP39 39

W/ car & truck, full size. Superb! (18.300-15)

\$20.00 EA

SHOP39P 39

W/ car & truck, 3/4 size photocopy (18.300-4)

\$15.00 EA

SHOP40 40

W/ car & truck, full size. Superb! (18.300-15)

\$20.00 EA

Shop Manual



SHOP41 41

W/ car & truck, full size. Superb! (18.300-15)

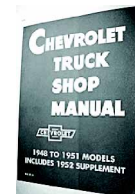
\$20.00 EA



SHOP42 42-48

Car & 42-46 truck, full size. Superb! (18.300-15)

\$20.00 EA



SHOP47 47-53

Original 48-52, full size. Superb! (18.300-15)

\$20.00 EA



SHOP47G 47-54

GMC, full size. Superb! (18.300-15)

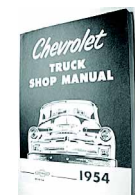
\$25.00 EA



SHOP47T 47

Original 1947 Only!! (18.300-15)

\$28.00 EA



SHOP54 54

Full size. Superb! (18.300-15)

\$20.00 EA

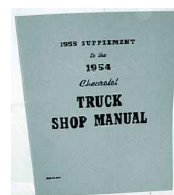


SHOP54S 47-54

Steering gear overhaul (18.300-15)

\$6.00 EA

Shop Supplement



SHOP55 55

1st series, full size (18.300-15)

\$5.00 EA

Providing part #'s speeds up your order, improves accuracy, and helps us maintain low prices.

See Illustration Index for core charge information and a list of abbreviations. For Body Model information, see 5T. 233



520T: Manuals, Accessory Books, Service Bulletins & Sales Brochures

Format = Part No., Year, Description, original Chevrolet Part Book Group No., Price and Unit Measure.

Good Housekeeping



HOUS1 ALL
In your car by GM,
Fisher body, removing
17 upholstery stains, 29
pages (18.300-2)
\$6.00 EA

Engineering Feature Manual



ENG37M 37
Car & Truck (18.230-15)
\$18.00 EA



ENG39M 39
Car & Truck (18.300-15)
\$15.00 EA



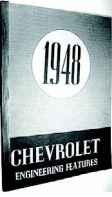
ENG40M 40
Car & Truck (18.300-15)
\$12.00 EA



ENG41M 41
Car & Truck (18.300-15)
\$12.00 EA



ENG47M 47
Car & Truck (18.300-3)
\$18.00 EA



ENG48M 48
Car & Truck (18.300-2)
\$12.00 EA

Engineering Feature Manual



ENG50T 50
Truck Only (18.300-15)
\$10.00 EA



ENG52M 52
Car & Truck (18.300-2)
\$12.00 EA



ENG53T 53
Truck Only (18.300-15)
\$12.00 EA



ENG54T 54
Truck Only (18.300-2)
\$15.00 EA

Service Bulletins

Note: 1 service bulletin was issued every month (except during WWII) to Chevrolet dealers on fixing new car problems. Introduction issue is previous year so we recommend three years for complete coverage of your vehicle. Invaluable.



SERV ALL
12 month, specify year
when ordering (-0)
\$16.00 EA

Engineering Feature Manual



ENG38M 38
Car & truck (18.500-15)
\$12.00 EA



ENG49T 49
Truck only (18.300-15)
\$12.00 EA

Engineering Feature Manual



ENG51T 51
Truck only (18.300-2)
\$12.00 EA

Glove Box Accessory Book



ACC37B 37
Gorgeous color repro of
original w/ pictures of all
those rare accessories.
(18.300-15)
\$9.00 EA



ACC38B 38
Repro of original w/
pictures of all those rare
accessories. Sepia, 9in.
x 11in. (18.600-15)
\$9.00 EA



ACC39B 39
Gorgeous color repro of
original w/ pictures of all
those rare accessories.
(18.600-15)
\$9.00 EA



ACC40B 40
Gorgeous color repro of
original w/ pictures of all
those rare accessories.
(18.600-15)
\$9.00 EA



ACC41B 41
Gorgeous color repro of
original w/ pictures of all
those rare accessories.
(18.600-15)
\$9.00 EA



ACC48B 46-48
Gorgeous color repro of
original w/ pictures of all
those rare accessories.
Original 48. (18.600-15)
\$9.00 EA

Returns require a return authorization number, please call.

530T: Factory Accessory Installation Books, Sheets & Templates



Format = Part No., Year, Description, original Chevrolet Part Book Group No., Price and Unit Measure.

Accessory Installation Manual



- ACC49M**49
Superb (18.000-15)
\$8.75 EA
- ACC50M**50
Superb (18.900-15)
\$8.75 EA
- ACC51M**51
Superb (18.900-15)
\$8.75 EA
- ACC52M**52
Superb (18.900-15)
\$8.75 EA
- ACC53M**53
Superb (18.900-15)
\$8.75 EA
- ACC54M**54
Superb (18.900-15)
\$15.00 EA
- ACC49E**49-54
Per accessory (18.900-0)
\$2.00 EA

Copies of originals wanted: Original accessory instruction sheets 1937-54 or sharp copies.

Accessory Identifying Book



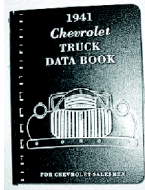
- ACC01B** 46-78
All accessories 1946-78 in numerical order, superb for identifying (18.600-2)
\$20.00 EA

Accessory List

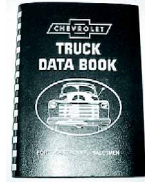


- ACC L**..... 37-54
With part numbers & prices (great for swap meets) (specify year @) (18.600-0)
\$3.00 EA

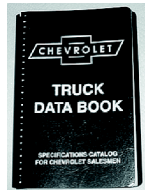
Data Book



- DATA41** 41-46
Salesman, all the specs, original 1941 (18.700-15)
\$25.50 EA



- DATA51** 47-53
Salesman, all the specs, original 1950 (18.800-15)
\$25.50 EA

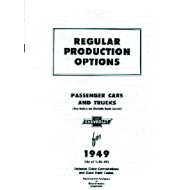


- DATA54**..... 54
Salesman, all the specs 1954 (18.800-15)
\$25.00 EA

RPO Booklet



- RPO47**..... 47
W/ regular production options (18.800-2)
\$4.50 EA



- RPO49**..... 49
W/ regular production options (18.800-2)
\$3.00 EA



- RPO53**..... 53
W/ regular production options (18.800-2)
\$3.00 EA



- RPO54**..... 54
W/ regular production options (18.800-2)
\$4.50 EA

Price Guide



- PRICE37** 37
Advertised delivered prices of vehicles & accessories (18.800-2)
\$3.00 EA



- PRICE38**..... 38
Advertised delivered prices of vehicles & accessories (18.700-2)
\$3.00 EA



- PRICE39**..... 39
Advertised delivered prices of vehicles & accessories (18.700-2)
\$6.00 EA

Casting Numbers



- CAST42**..... 29-42
Identification book (18.700-15)
\$6.50 EA

Sales Brochure



- SALE T** 42-54
Super color reproduction of original brochure (specify year when ordering) (18.600-2)
\$9.00 EA



- SALE55T2** 55
2nd series (18.000-15)
\$6.50 EA

Antenna Installation Sheets

- ACC65I** 37-40
Under running board (original 40) (-0)
\$2.00 EA

Providing part #'s speeds up your order, improves accuracy, and helps us maintain low prices.

See Illustration Index for core charge information and a list of abbreviations. For Body Model information, see 5T. 235



530T: Factory Accessory Installation Books, Sheets & Templates

Format = Part No., Year, Description, original Chevrolet Part Book Group No., Price and Unit Measure.

Antenna Installation Sheets

- 985531I** 39-46
Install instructions (18.900-4)
\$2.00 EA
- ACC76I** 47-54
Includes template (18.900-0)
\$2.00 EA

Cigarette Lighter Installation Sheet

- ACC45I** 42-53
(18.900-0)
\$2.00 EA

Compass Installation Sheets

- ACC25I** 37-42
For glove box (18.900-3)
\$2.00 EA
- ACC26I** 46-48
For glove box (18.900-3)
\$2.00 EA

Fog Light Installation Sheets

- ACC18I** 41
(18.900-3)
\$2.00 EA
- ACC40I** 42-48
(18.900-0)
\$2.00 EA

Gas Filter Installation Sheet

- ACC56I** 33-56
Genuine AC (18.900-0)
\$2.00 EA

Glove Compartment Lamp Installation Sheet

- ACC02I** 41-54
(18.900-15)
\$1.00 EA

Heater & Defroster Installation Sheet

- ACC23I** 47-48
Non-fresh air, also COE (18.900-3)
\$2.00 EA

Heater Installation Sheet

- ACC61I** 47-53
Recirculating (18.900-4)
\$2.00 EA

Heater Installation Sheet

- ACC47I**..... 47-53
Recirculating, 3000-4000-6000 series
(18.900-0)
\$2.00 EA

Town & Country Horn Installation Sheet



- ACC62I** 37-38
(Matched) with City & Country switch, original 37 (18.900-4)
\$2.50 EA

- ACC09I**..... 39
(Matched) with City & Country switch, original 39 (19.900-4)
\$2.50 EA

- ACC10I**..... 40-42
(18.900-4)
\$3.00 EA

Lock & Key Service Manual

- ACC89I**.....ALL
9 pages (18.900-4)
\$5.00 EA

Mirror-Vanity Installation Sheet

- ACC63I**..... 37-41
With vertical lights (18.900-0)
\$2.00 EA

Mirror-Peep Installation Sheet

- ACC53I**..... 37-50
(18.900-4)
\$1.00 EA

Oil Filter Installation Sheet

- ACC88I**..... 37-41
Original AC (18.900-4)
\$3.00 EA
- ACC66I**..... 42-47
Original AC (18.900-0)
\$4.00 EA
- ACC87I**..... 48-49
Original AC (18.900-0)
\$3.00 EA
- ACC67I**..... 50-52
Original AC (18.900-0)
\$2.00 EA

Oil Filter Installation Sheet

- ACC68I** 53-55
Original AC (18.900-0)
\$2.00 EA

Overflow Tank Installation Sheet

- ACC07I** 37-48
Install instructions (18.900-3)
\$2.00 EA
- ACC08I** 49-54
(18.900-3)
\$2.00 EA

Park Light Installation Sheet

- ACC60I** 37-39
Fender lamps (18.900-0)
\$2.00 EA

Passing Lamp Installation Sheet

- ACC19I** 41
(18.900-3)
\$2.00 EA

Radiator Insect Screen Installation Sheet

- ACC71I** 47-53
(18.900-0)
\$2.00 EA

Radio Manual

- 985538M**..... 40
5 tube, 4 button (original 40). (18.900-4)
\$3.00 EA
- 985424M**..... 40
8 tube w/ installation (18.900-0)
\$3.00 EA



- 986067M**..... 47-50
Original 47 (18.900-0)
\$6.00 EA
- 986777M**..... 54
(18.900-0)
\$6.00 EA

Returns require a return authorization number, please call.



Format = Part No., Year, Description, original Chevrolet Part Book Group No., Price and Unit Measure.

Radio Shop & Service Manual

ACC44147-53

Original 50 (18.900-15)

\$9.75 EA

Sunvisor

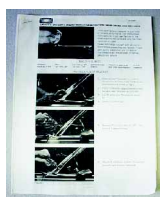
ACC571 **ALL**

Application chart for Fulton exterior visor.

(18.900-0)

\$2.00 EA

Spotlight Template



ACC391 **37-54**

W/ instruction

(18.900-0)

\$2.00 EA

AST **39-46**

W/ Instruction (18.900-0)

\$2.50 EA

Umbrella Holder Installation Sheet

ACC111 **ALL**

(00.000-3)

\$2.00 EA

Underhood Lamp Installation Sheet

ACC82149-54

(18.900-0)

\$1.00 EA

Utility Pocket Unit Installation Sheet

ACC70148-50

(18.900-0)

\$2.00 EA

Windshield Washer Installation Sheet

ACC591 **38-39**

(18.900-0)

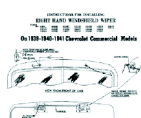
\$2.00 EA

ACC12140-42

(18.900-3)

\$2.00 EA

Windshield Wiper Installation Sheet



ACC721 **39-46**

Right (18.900-0)

\$2.00 EA

Providing part #'s speeds up your order, improves accuracy, and helps us maintain low prices.

See Illustration Index for core charge information and a list of abbreviations. For Body Model information, see 5T. 237



550T: Original Cards, Metal Tags, Decals & Shop Signs

Format = Part No., Year, Description, original Chevrolet Part Book Group No., Price and Unit Measure.

Air Cleaner



AIR350 34-39
Oil bath decal
(18.900-15)
\$1.25 EA



AIR37 37
Dry decal (19.300-15)
\$2.50 EA



AIR38T 38-46
Dry decal (19.300-2)
\$5.25 EA



AIR400T 40-54
Oil bath decal
(19.300-15)
\$4.00 EA



AIR470T 47-59
Oil bath decal, heavy duty (19:300-3)
\$4.00 EA



AIR47T 47-54
Dry decal (19:300-15)
\$1.25 EA

Antifreeze



TAG10 ALL
GM tag (19.300-2)
\$5.25 EA

Battery



TAG03 ALL
Guarantee card
(19.100-3)
\$4.50 EA

Break-in Instructions



TAG11 48-56
Card (19.100-2)
\$5.50 EA

Break-in Instructions



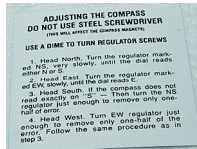
TAG01 39-47
Card (19.100-2)
\$3.50 EA

Cigar Lighter



TAG02 39-50
Card-Casco (19.100-2)
\$3.00 EA

Compass



DEC12 37-59
Instruction decal
(19.100-3)
\$3.00 EA



TAG23 37-42
Tag (cut in outline of compass) (19.200-0)
\$2.50 EA

Data Plate (Metal)



PLATE39T 39-41
Right side cowl 1/2T
(19.100-15)
\$16.90 EA



PLATE42T 42-46
Right side cowl 1/2T
(19.400-15)
\$15.00 EA



PLATE47T 47-49
Door post 1/2T
(19.400-15)
\$17.00 EA

PLATE50G 50
Door post 1/2T, GMC (19.400-15)
\$17.00 EA



PLATE50T 50
Door post 1/2T
(19.400-15)
\$17.00 EA

Data Plate (Metal)



PLATE51T 51-52
Door post 1/2T
(19.400-15)
\$17.00 EA

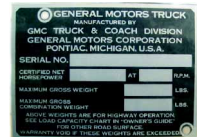


PLATE53G 53
Door post 1/2T, GMC
(19.400-15)
\$17.00 EA



PLATE53T 53
Door post 1/2T
(19.400-15)
\$17.00 EA



PLATE54G 54
Door post 1/2T, GMC
(19.400-15)
\$17.00 EA



PLATE54T 54
Door post 1/2T
(19.400-15)
\$17.00 EA

Delco Remy Tag



PLATE07 37
Generator, starter & dist (19.400-3)
\$10.00 EA



PLATE05 38-54
Generator, starter & dist (19.400-15)
\$6.00 EA

Returns require a return authorization number, please call.

550T: Original Cards, Metal Tags, Decals & Shop Signs



Format = Part No., Year, Description, original Chevrolet Part Book Group No., Price and Unit Measure.

Generator Warning Tag



TAG04.....ALL
(19.400-3)
\$3.25 EA

Hat Pin



5040ALL
Chevy bowtie w/ year
(specify year when
ordering) (19.100-0)
\$4.00 EA

Heater



DEC06..... 47-55
On/off defroster decal.
(18.800-15)
\$2.00 EA



DEC07..... 47-52
Chevrolet round
emblem. (19.200-15)
\$8.75 EA



DEC08..... 47-52
GMC round emblem.
(19.200-15)
\$8.75 EA



DEC29..... 49-51
Decal-Harrison
(19.200-2)
\$3.50 EA



DEC09..... 53
Fresh air round decal.
(19.200-15)
\$2.50 EA



DEC17..... 53
Recirculating round
decal. (19.200-15)
\$3.50 EA

Heater



DEC10..... 53-54
GMC round decal.
(19.200-15)
\$2.50 EA



DEC16..... 54-55
Fresh air round decal.
(19.200-15)
\$2.50 EA



DEC18..... 54-55
Recirculating round
decal. (19.200-15)
\$2.75 EA

Key Decal



DEC11..... 36-54
Glove box (19.200-3)
\$5.50 EA

Lubrication Sticker



DEC05.....ALL
Chevrolet script (blue,
yellow & white)
(19.200-0)
\$0.50 EA

Mirror Glare Proof



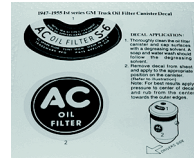
TAG09.....ALL
Day-night card hangs
on mirror arm (nice!)
(19.200-0)
\$2.50 EA

Oil Filter



DEC30..... 37-41
Decal, original, AC
Kleer Kleen (19.100-2)
\$6.00 EA

Oil Filter



DEC04 42-54
Decals-set of 2, original
AC (19.200-15)
\$3.50 EA



DEC19 40-49
Decal set (1940's) Fram
3-piece (19.200-2)
\$5.00 EA



DEC20 50-59
Decal set (1950's) Fram
4-piece (19.200-2)
\$9.75 EA

Overflow Tank Decal



DEC03 39-48
Gold with red wings
(gorgeous!) (19.200-4)
\$5.00 EA



DEC28 49-54
(19.200-2)
\$6.00 EA

Paint Lacquer



TAG16 53-58
Instruction card
(19.200-2)
\$3.50 EA

Quality Control Card



TAG15 49-54
(19.100-2)
\$3.50 EA

Providing part #'s speeds up your order, improves accuracy, and helps us maintain low prices.

See Illustration Index for core charge information and a list of abbreviations. For Body Model information, see 5T. 239



550T: Original Cards, Metal Tags, Decals & Shop Signs

Format = Part No., Year, Description, original Chevrolet Part Book Group No., Price and Unit Measure.

Service Policy



TAG25 37-51
(19.100-2)
\$3.50 EA



TAG13 51-59
(19.100-2)
\$3.50 EA

Sign



SIGN01..... ALL
Chevrolet metal sign 12-1/2in. x 15-1/2in.
(19.100-15)
\$31.50 EA



SIGN03..... ALL
Chevrolet decal (as on metal sign) (19.450-15)
\$8.75 EA



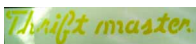
SIGN02..... ALL
GMC metal shop sign, 12-1/2in. x 15-1/2in.
(19.450-15)
\$31.50 EA

Spotlight Card



TAG08 37-54
Original S3-S4 hung on light (19.450-4)
\$3.00 EA

Valve Cover Decal



DEC15 47-53
Thriftmaster for 216ci
(19.100-2)
\$4.50 EA



DEC25 54
Thriftmaster 235ci
(19.200-2)
\$4.50 EA

Warranty Card



TAG14 54-60
(19.200-2)
\$3.50 EA

Windshield Washer



DEC02 39-50
Decal on metal basket
(19.100-2)
\$3.00 EA

Windshield Washer



DEC13 51-54
Lid decal (19.200-2)
\$6.00 EA



DEC14 51-54
Basket decal (19.200-2)
\$5.25 EA



1942 Military Truck—Dave Seabrook
(This page and next.)

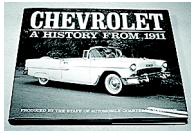
Returns require a return authorization number, please call.

560T: Books



Format = Part No., Year, Description, original Chevrolet Part Book Group No., Price and Unit Measure.

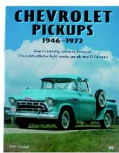
Books



BOOK08..... 11-80
Chevrolet, a history from 1911-1980 (19.200-15)
\$40.00 EA



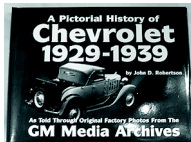
BOOK06..... 47-54
Advanced design 47-54 trucks-10 pages of detailed specs & features each year (19.500-4)
\$4.50 EA



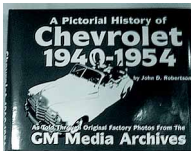
BOOK10..... 46-72
Chevrolet pickups. 190 pages w/ history, pictures and specifications on how to identify, select and restore 1946-72 light trucks, panels and El Caminos. (19.500-15)
\$23.00 EA



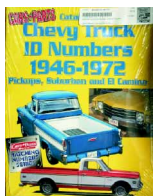
BOOK11..... ALL
American salvage yard treasures (19.500-15)
\$20.00 EA



BOOK12..... 29-39
Pictorial history of chevrolet cars 1929-39 (19.500-15)
\$31.00 EA



BOOK13..... 40-54
Pictorial history of chevrolet cars 1940-54 (19.500-15)
\$31.00 EA



BOOK15..... 46-72
Identification guide - Chevy truck 1946-72 (19.500-4)
\$25.00 EA



560t

Providing part #'s speeds up your order, improves accuracy, and helps us maintain low prices.

See Illustration Index for core charge information and a list of abbreviations. For Body Model information, see 5T. 241



Index

Format = Part No., Year, Description, original Chevrolet Part Book Group No., Price and Unit Measure.

Numerics

1934-39 Tail Light 79	1947-53 Tail Light Assembly ...78	Antenna Installation Sheets . 235, 236
1937 "Gangster Grille" 147	1947-53 Tail Light Panel & Suburban (optional Tail Lights) 79,80	Antenna Pad 197
1937 Clips-Moulding 147	1954 Bolt Kit149	Antifreeze 238
1937 Crank Hole Cover 147	1954 Grille149	Anti-Rattle Rubber Spacer 109
1937 Grille 147	1954 Radio199	Applicator 17
1937 Grille Center Strip 147	1954 Tail Light80	Arm 208
1937 Grille Emblem 147	1954-55 (1st Series) New Radio . 197	Arm Rest Bracket 208
1937 Grille-Billet Aluminum Bars 147		Artwork 12
1937 Grille-Side Moulding 147	A	Ash Tray Knob 187
1937 Radio 197	AC Parts Catalog233	Assembly Manual 233
1938 "Gangster Grille" 148	Accessory Identifying Book ...235	B
1938 Crank Hole Cover 148	Accessory Installation Manual 235	Back Glass 214
1938 Grille 148	Accessory List235	Back Glass & Frame213, 223
1938 Grille Center Strip 148	Adapter-Air Cleaner83	Back Glass Rubber 223
1938 Radio 197	Adhesive153	Back Up Light 81
1939 Grille 148	Adhesives219	Backing Plate-Water Pump 44
1939 Grille Center Strip 148	Adhesives & Sealers21	Ballast Resistor 57
1939 Grille Lettering 148	Air Cleaner238	Balls 122
1939 Radio 197, 198	Air Conditioning & Heating System47	Basic Noise Barrier Kit 175
1940 Grille 148	Air Conditioning & Heating System-Upgrade47	Battery177, 238
1940 Grille Center Strip 148	Air Conditioning Compressor ..47, 48	Battery Cover 55, 169, 177
1940 Grille Lettering 148	Air Filter87	Battery Cover Gasket 55
1940 Radio 198	Air Filter Element 83, 87	Battery Disconnect 53
1940's Headlight Assembly 71	Alignment Tool36	Battery Hold Down 55
1940-53 License Light Lens 81	All Steel Cab w/ Mounted Hinged Doors167	Battery Mat 55
1940-53 Tail Light 79	Alternator53	Battery Minder20, 53
1941 Radio 198	Alternator Pulley53	Battery Tender Plus19, 53
1941-46 Grille 148, 149	Antenna197	Battery Tray 55
1941-46 Grille Emblem 149	Antenna Base197	Battery Tray Paint 55
1941-46 Grille Lettering 149	Antenna Base & Nut197	Beanie Bear 12
1941-46 Moulding Clips 149	Antenna Eye Bolt197	Bearing99, 121
1941-46 Screw Set 149		Bearings & Balls For Steering Worm Gear121, 122
1942-1946 Radio 198		Beauty Ring 138
1947-1953 Radio 198, 199		Bed Assembly 233
1947-53 Grille 149		Bed Mounting Blocks 230
1947-53 New Radio 197		Bed Mounting Rubber Pads .. 230

Returns require a return authorization number, please call.

Index



Format = Part No., Year, Description, original Chevrolet Part Book Group No., Price and Unit Measure.

Bed Side Panel	228	Brake Pedal Return Spring ..	109, 167	Cab Front Lower Corner	166
Bed Strips	228, 229	178		Cab Mount	172
Bed Wood	229	Brake Residual Valve	108	Cab Mount Body To Frame ..	172
Bed Wood & Bed Mount Bolts	230	Brake Shoe Hold Down	110	Cab Mount Bolt Set	172
230		Brake Shoe Hold Down Kit ...	110	Cab Mount Brace (Front)	168
Bed Wood Washer	229, 230	Brake Shoe Return Springs ..	110	Cab Mount Brace (Rear)	168
Bee Hive Oil Filter	36	Brake Shoe Springs	110	Cab Mount Pads	172
Bee Hive Oil Filter Bracket	36	Brake Shoes	110	Cab Mount Rear	172
Belt	45, 54	Break-in Instructions	238	Cab Mount Wood Blocks	172
Bezel-Gauge Cluster	193	Bulbs	76, 77	Cab Roof	167
Billet Caps	226	Bulbs-Halogen	75, 76	Camshaft	33, 34
Billet Specialties Wheels	136	Bulbs-LED	76	Camshaft Bearings	34
Bleeder Valve	113	Bumper	178	Camshaft Thrust Plate & Spacer	34
Blue Dots	78	Bumper Bolt	144, 145	Camshaft Thrust Plate Screws	34
Body Deadener	176	Bumper Bracket	145	Carburetor	87
Body Mount Pads	172	Bumper Guard	144	Carburetor Base Gasket	88
Bolt	127, 134, 202	Bumper-Axle	127	Carburetor Cleaner	88
Bolt & Bushing	127, 134	Bumper-Rear Axle	134	Carburetor Insulator	88
Bolt & Washer Set	155	Bumpers - Briz	142	Carburetor Parts	88
Bolt Kit	149	Bumpers (Rubber)	153	Carburetor Rebuild Kit	87, 88
Bolt Set	177	Bumpers-Chrome	144	Carpet & Upholstery Cleaner ..	17
Bolt-Bumper	144	Bumpers-Painted	144	Carpet With Pad	176
Books	233, 241	Bumpers-Polished Stainless	142, 143	Carrier Bearing	105
Boot	109	143		Caster Adjusting Wedges	123
Brace (V-Rod)	150	Bumpers-Triple Plated Chrome ..	144	Casting Numbers	235
Brace (V-Rod) Street Rod	42	144		Channel (Guide)	219
Bracket-Hood Hinge	154	Bushing	45, 99, 133, 134, 178	Channel Kit	222
Bracket-Shift Tube Support	99	Bushing & Bolt W/ Nut	105	Check Link Bumper	210
Bracket-Tailgate Chain	232	Bushing In Cylinder Head	194	Choke Cable Assembly	186
Brake Adjust Hole Plugs	110	Bushing-Pitman Shaft	122	Choke Knob	186
Brake Cleaner	113	Bushings	109, 126, 178	Chrome Bezel	204
Brake Drum	109, 110	Butter Wax	17	Chrome Lock Strip	223
Brake Fluid	21, 113			Cigar Lighter	238
Brake Hose	110	C		Cigarette Lighter	187
Brake Light Switch	113	Cab Back Panel - Lower	167	Cigarette Lighter Installation	
Brake Line Junction Block	113	Cab Back Panel - Upper	167	Sheet	236
Brake Line Junction Bolt	113	Cab Corner Patch Panel - Inner ..	167		
Brake Line Sets	111	167			
		Cab Corner Patch Panel - Outer			

Providing part #'s speeds up your order, improves accuracy, and helps us maintain low prices.

See Illustration Index for core charge information and a list of abbreviations. For Body Model information, see 5T. 243



Index

Format = Part No., Year, Description, original Chevrolet Part Book Group No., Price and Unit Measure.

Clamp 64, 84, 108	Conversion Kit133	Delco Remy Tag 238
Clamp-Air Cleaner 83	Copper Washer111	Detail Spray 16
Clamp-Gas Filler Hose 85	Core charge information3	Differential Fill 105
Clay Bar 16	Core Support Bolt Kit43, 150	Dimmer Switch 74
Cleaner Assembly 83	Core Support Pads & Shims ...43,	Disc Brake Conversion Brackets
Cleaner-Brake 21	150	108
Cleaner-Carburetor 21	Corner Strips229	Disc Brake Conversion Kit 108
Clevis End Pin 109	Coupling Pin103	Distributor 58
Clip 64, 89, 113	Cover-Wiper Motor Access Hole .	Distributor Cap 58
Clips-Moulding 192	181,201	Division Bar 219
CLK (Cam & Lifter Kit) 30	Cowl Panel - Metal Upper166	Dome Light Lens 182
CLK3 (Cam, Lifter Kit & Timing	Cowl Patch Panel Metal Outer	Door - Metal 165
Gears) 30	166	Door Arm Rests 208
Clock Quartz Conversion 194	Cowl Vent166	Door Bumper 212
Clocks 15	Cowl Vent Filler Panel171	Door Check Link Assembly ... 210
14-3/4-in. Diameter14, 15	Cowl Vent Knob 185, 201	Door Check Link Springs 210
20-in. Diameter 14	Cowl Vent Seal201	Door Glass 214
Cluster Gear 99	Cylinder Head Bolts34	Door Handle Exterior 206
Cluster Shaft 99	Cylinder Sleeves32	Door Handle Exterior Guard . 206
Clutch Bit Holder 19, 73, 156, 180,	D	Door Handle Exterior Return
208	D.A. Plug53	Spring 206
Clutch Head Bits 19, 73, 156, 180,	Dampner-Balancer 35, 39	Door Handle Interior 207
207, 208	Dash Moulding Speaker Grille	Door Hinge Post Lower 167
Clutch Head Bolt 156	194	Door Latch Assembly206, 207
Clutch Head Driver W/ Bits 19, 73,	Dash Panel191	Door Latch Post Lower 167
..... 156, 180, 207	Data Book235	Door Latch Striker 206
Clutch Head Screw Set 207	Data Plate (Metal)238	Door Lock 206
Clutch Head Screws 72	Decal Defroster49	Door Lock Gasket 206
Column Floor Mounts118, 119	Decal Heater49	Door Lock Knob 206
Column Shift Knob 186, 187	Decal Hub Cap138	Door Panel-Metal Frames 209
Compass 238	Decal Instrument Set193	Door Panels 181
Compass Installation Sheets 236	Decal Radio Grille194	Door Panels Cardboard 208
Complete Bed - Assembled .. 227	Decals Grille 149, 150	Door Patch Panel159, 162
Complete Bed - Unassembled	Decals-Grille152	Door Patch Panel (Inner) 165
227	Decals-Hood Emblem152	Door Patch Panel (Outer) 165
Complete Bed Upgrade 227	Defroster Duct Hose48	Door Pillar 165
Condenser 58	Delco Remy Metal Tag 52, 53, 54,	Door Sill Seal 211
Control Rod Assembly 109	58	Door Skin 159

Returns require a return authorization number, please call.

Index



Format = Part No., Year, Description, original Chevrolet Part Book Group No., Price and Unit Measure.

Door Strap Check Bracket 210	Exhaust System 92	Floor Shift Boot 98, 177
Door Vent Glass 214	Expansion Plug 35	Floorboard 160, 163
Door Weatherstrip 211	Eye Bolt 232	Floorshift Seal 98, 177
Door Windlace 211		Fog Light 69, 77
Dovetail Bumper 212	F	Fog Light Bracket 69
Dowel Pin 103	Fender Brace 155, 156	Fog Light Emblem 69
Drag Link 122	Fender Cover 20	Fog Light Installation Sheets 236
Drag Link Kit 122	Fender Front (Fiberglass) 155	Fog Light Lens 69
Drag Link Rebuild Kit 122	Fender Front (Steel) 155	Fog Light Rim 69
Drag Link Seals 122	Fender Gaskets 156	Folder 233
Drip Rail 165	Fender Rear (Fiberglass) 155	French Stitching Option 183
Drive Shaft Bushing 103	Fender Rear (Steel) 156	Front Bed Panel 228
Drive Shaft Seal 103	Fender Skirts 157	Front Leaf Spring 127
Driver's Side Vent Filler 171	Fender Welting 156	Front Mat 176
Driving Light 77	Fenton Headers 91	Front Wheel Bearing Seal 139
Driving Lights 69	Fenton Heat Kit 82, 91	Front Wheel Bearing-Inner ... 139,
Drying Towel 17	Fenton Intake 82	140
Dual Action Shock 133	Fenton Intake 2 Carb 82	Front Wheel Bearing-Outer ... 140
Dust Cover 139	Ferrule 207	Fuel Fill Bowl 84
	Ferrule Tool 207	Fuel Filler Concealment Kit ... 225
E	Filler Panel 150	Fuel Filter 86
Economy Noise Barrier Kit 175	Firewall (steel) 166, 170	Fuel Pump 86, 87, 202
EK Engine Kit 30	Firewall Grommets 173, 174	Fuel Pump Rebuild Kit 87, 202
Electric Wiper Conversion - Bolt In 200	Firewall Pad-Fiber Board w/ Insulation 173	Fuel Pump to Carb Fuel Line .. 88
Electric Wiper Conversion Kit 200	Firewall Pad-Fiberglass w/ Insulation 173	Fuel Pump-Electric 82
Emergency Brake Bracket 109, 169	Firewall Pad-Polyurethane w/ Insulation 173	Fuel Stabilizer 20, 85
Emergency Brake Cable 109	Flange Bracket 230	Fuse Holder 70
Emergency Brake Release ... 109, 185	Flange Plate 92	G
Emergency Pedal Boot 177	Flasher Socket 66	Gas Cap 85
Engine Assembly Lube 35, 40	Float 86	Gas Filter Installation Sheet .. 236
Engine Bolt Kit Stainless Steel 31	Floor Insert Over Transmission ... 169	Gas Pedal 178
Engine Crank 51	Floor Kit 171	Gas Tank 82, 84
Engine Kit 30	Floor Pan 168	Gas Tank Cleaner 20, 86
Engineering Feature Manual .234	Floor Panel (from seat forward) .. 169	Gas Tank Fill Hose Kit 85
Exceptions 3		Gas Tank Filler Flange 84
Exhaust Extension 94		Gas Tank Mounting Bracket ... 84
		Gas Tank Mounting Pad 84
		Gas Tank Restoration Kit ... 20, 85

Providing part #'s speeds up your order, improves accuracy, and helps us maintain low prices.

See Illustration Index for core charge information and a list of abbreviations. For Body Model information, see 5T. 245



Index

Format = Part No., Year, Description, original Chevrolet Part Book Group No., Price and Unit Measure.

Gas Tank Sealer	86	45	Grommet-Gas Gauge Wire	86	
Gas Tank Sealer Slosh	20	Gauge Cluster	191, 192	Grommets-Bumper	144
Gas Tank Sending Unit	86	Gauge Repair	192	Grommet-Wiper Control Link	202
Gasket 92, 93, 109, 111, 122, 177, 195,	203	Gauges	191, 192	Ground Strap	55
Gasket (Intake-Exhaust Manifold) 40		Gauges-Classic Instruments	.190	H	
Gasket Sealer	21, 40, 45	Gearshift Arm (Flaming River)	118	Halogen Headlight Conversion	71
Gasket Set	156	Generator	54	Halogen Headlight Conversion-Bulb	75
Gasket-Axle	105	Generator Band	54	Hand Brake Seal	177
Gasket-Backing Plate (Water Pump)	44	Generator Bearing	54	Hat Pin	239
Gasket-Brake Drum	110	Generator Bolt & Nut	54	Header Panel	181, 201
Gasket-Door Handle	206, 207	Generator Brush Set	54	Header Pipe	93
Gasket-Fuel Pump	86	Generator Bushing	54	Headlight	76
Gasket-Gas Tank Sending Unit ..	86	Generator Oil Fill Cover	54	Headlight - Halo Halogen	75
Gasket-Head	39	Generator Pulley	54	Headlight - Halogen	75
Gasket-Head To Water Outlet	45	Generator Rebuild Kit	54	Headlight - Halogen with LED Turn Signal. AutoNik Slick Signals	75
Gasket-Headlight Bucket	72	Generator Rebuild Service	54	Headlight Bucket	72
Gasket-Hood Emblem	152	Generator Warning Tag	239	Headlight Bucket Assembly	72
Gasket-In Line Filter Bowl	86	Glass Bowl	86	Headlight Bucket Spring	73
Gasket-Instrument	193	Glass Channel Kit	219	Headlight Housing	72
Gasket-Manifold	40, 89, 92	Glove Box Accessory Book ...	234	Headlight Knob	185, 186
Gasket-Mirror Arm	189	Glove Box Door	194	Headlight Lens	72
Gasket-Oil Distributor Valve ...	40	Glove Box Light	195	Headlight Lens Seal	73
Gasket-Oil Fill Cap	40	Glove Box Lock	195	Headlight Pigtails	63
Gasket-Oil Pan	39	Glove Box-Cloth Lined	194	Headlight Relay	74
Gasket-Overhaul	39	Glove Box-Like Original	194	Headlight Rim	73
Gasket-Push Rod Cover	40	Glove Compartment Lamp Installation Sheet	236	Headlight Rim Seal Clip	73
Gaskets, Seals, Bearings	105	GM Script Tag	70	Headlight Stand Mounting Pad	72
Gaskets-Running Board To Fender	158	Good Housekeeping	234	Headlight Switch	73, 74
Gasket-Timing Cover	39	Grease Fitting	126, 133, 134	Headlight Switch Retaining Nut ..	74
Gasket-Valve Cover	39	Grille Filler Panel	150	Headlight Switch Shaft	74
Gasket-Valve Grind	39	Grille Shell	150	Headlight Visor	71, 72
Gasket-Water Pump	44	Grommet	109, 121, 183, 215	Headlight Wire Grommet	.72, 156
Gasket-Water Pump To Block	44,	Grommet-Emergency Brake Release	185	Headlight-Frenched Kit	71
		Grommet-Fuel Fill Bowl	84	Headliner Bow	180
		Grommet-Gas Filler	85	Headliner Conversion	179

Returns require a return authorization number, please call.

Index



Format = Part No., Year, Description, original Chevrolet Part Book Group No., Price and Unit Measure.

Headliner Extension	179	Hood Emblem	152	Ignition Coil - Pertronix 12 Volt	57
Headliner Washers	180	Hood Handle	153	Ignition Coil - Pertronix 6 Volt .	57
Headliner-Die Cut	179, 180	Hood Hinge	154	Ignition Lock	57, 59
Headliner-Molded ABS Plastic	179	Hood Hinge Bolt	153, 154	Ignition Switch	57, 59
Headliner-Moulded	179	Hood Latch Lower Assembly	151, 165	Ignition Switch Mounting Plate	57, 59
Headliner-Moulded Fiberglass	179	Hood Ornament	151, 152	Ignition System, Eletronic -	
Heat Riser Shaft	92	Hood Side Clips & Bolts	153	Pertronix	57
Heat Riser Spring	92	Hood Side Emblem	152, 153	Illustration Index	3
Heater	239	Hood Side Moulding	153	Inner Fender Apron Kit	171
Heater & Defroster Hose	48	Hood Sides-Fiberglass	151	Inner Fender Panel (Fiberglass) .	155
Heater & Defroster Hose Clamps	48	Hood -Steel	151	Inner Fender Panel-Front	155
Heater & Defroster Installation		Hood To Cowl Seal	153	Instrument Glass	191, 192
Sheet	236	Hood To Grille Seal	153	Insulation	173
Heater & Defroster Knob		Hood-Fiberglass	151	Insulator	51, 121
3129274C	48	Horn	60	Interior Screws	180, 209
Heater & Defroster Motor	49	Horn Button	60	Intermittent Delay Switch	200
Heater & Defroster Shutoff Valve	48	Horn Button Assembly	60		
48		Horn Button Contact	60	J	
Heater Box	49	Horn Button Pad	60	J-nut Retainer	180
Heater Control Valve	48	Horn Button Spring	60	Jute Insulation Pad	176
Heater Control Valve Rebuild Kit .	48	Horn Button S-wire	60		
48		Horn Contact Plate	60	K	
Heater Core Rebuild	49	Horn Harness	63	Key	59, 195, 206
Heater Gasket	48	Horn Installation Sheet	236	Key Decal	239
Heater Grommet	48	Horn Relay	60	Kick Panel-Metal Repair Panel ...	169
Heater Harness	63	Horn Wire Grommet	60	Kick Panels	181, 208
Heater Installation Sheet	236	Horns	60	King Pins	126, 127
Heater Motor	49	Hose	201, 202	Knob	215, 220, 221
Heater Nipple	48	Hose Connector 3-way	202	Knob-Window or Windshield .	185
Heater Switch	48	Hose Set	43		
Hinge Pin	210	Hose-Gas Tank Filler	85	L	
Hinge Seal	210	Hub Caps-Custom	136, 137	Leather Conditioner	17
Hold Down Screw	58	Hub Caps-Modified	136	LED 1940-53 Tail Light Assembly	78
Hood Center Strip	151	Hub Caps-Stock	137, 138	LED 1947-53 Tail Light Assembly	78
Hood Corners	153			LED Insert W/ Lens	78
		I		LED Lens & Reflector	78
		Ignition Coil	57, 58		
		Ignition Coil - Pertronix	57		

Providing part #'s speeds up your order, improves accuracy, and helps us maintain low prices.

See Illustration Index for core charge information and a list of abbreviations. For Body Model information, see 5T. 247



Index

Format = Part No., Year, Description, original Chevrolet Part Book Group No., Price and Unit Measure.

License Fastener 145	Metal Retainer 158, 211	Offenhauser Intake 2 Carb 83
License Light Pad 81	Metal Trim Plate 208	Offenhauser Intake 3 Carb 83
License Plate Bracket 81, 145	Mirror Arm-Exterior 188, 189	Oil Dip Stick Tube 36
License Plate Frame 146	Mirror Bracket-Interior 188	Oil Distributor Valve 36
Lifters 33	Mirror Glare Proof 239	Oil Fill Cap 35, 36
Lighter Element 187	Mirror Head 188	Oil Filter 239
Line Clamp 84, 98, 108	Mirror-Peep 188	Oil Filter Element 36, 37
Liner 127	Mirror-Peep Installation Sheet 236	Oil Filter Hose 37
Lock & Key Service Manual .. 236	Mirror-Rear View (Day/ Night) 188	Oil Filter Installation Sheet 236
Long Tie Rod 122	Mirror-Rear View (Interior) 188	Oil Pad 20
Lower Hoses 44	Mirror-Vanity Installation Sheet ... 236	Oil Pan Plug 35
Lowering Blocks 133	Model 1	Oil Pickup-Grommet 36
Lubrication Sticker 239	18 Scale 1941 Cabriolet ... 13	Oil Pressure Line 36, 194
Lug Nut 139	18 Scale 1948 Woody 13	Oil Pump 36
M	24-1	Oil Pump Drive Gear 36
Main Bearings 31	27 Scale 1941 Cabriolet 13	Oil Pump Rebuild Kit 36
Main Fuel Line 88	27 Scale 1948 Low Rider	One Piece V-Bent Windshield
Main Wire Harness-Chevrolet . 62	Woody 13	Glass 213
Main Wire Harness-Replacement	27 Scale 1953 Truck 13	O-rings 57
Chevrolet 62, 63	Modular Fuse Panel System ... 61	Overflow Tank 43
Main Wire Harness-Replacement	Motor Mount-Front 41	Overflow Tank Decal 239
GMC 63	Motor Mount-Rear 41	Overflow Tank Installation Sheet
Main Wire Harness-Street Rod 62	Moulded Lower Hose 44	236
Master Cylinder 111	Moulding 215	Owner's Manual 233
Master Cylinder & Brake Booster	Mount Bracket 53	P
Assy 108	Mounting Gasket-Fuel Pump ... 86	Pad-Headlight Bucket 72
Master Cylinder Rebuild Kit .. 111	Mud Flaps 157	Pad-Mirror Arm 189
MEK1 Engine Kit 30	Muffler 93	Pads & Shims-Radiator 150
MEK2 Engine Kit 30	Muffler Clamp 93	Paint 94
Metal Clips 173	Muffler Hanger 93	Paint Lacquer 239
Metal Cover 41	N	Paint-Battery Tray 23
Metal Elbow 43	Nude Lady 137	Paint-Cab Interior 23
Metal Filler Panel 166	Nuts 204	Paint-Carburetor 23
Metal Frame Joint Clips 209	O	Paint-Cast Blast 24
Metal Plug 99, 177	Oakie Bushing 103	Paint-Engine 22
Metal Polish 18	Odds & Ends 52, 59	Paint-Exhaust 23
Metal Polish & Sealer 18		Paint-Heater 23, 49
Metal Prep 20, 85		Paint-Hub Caps & Trim 24

Returns require a return authorization number, please call.

Index



Format = Part No., Year, Description, original Chevrolet Part Book Group No., Price and Unit Measure.

Paint-Inner Fender Panel24	Driven Bolt In 220	Remote w/ Linkage 208
Paint-Radio & Heater23	Price Guide 235	Retainer206, 211
Paint-Zero Rust22	PRK (Piston & Ring Kit) 30	Retainer Button 181, 209
Panel Below Grille 150	Pros Pick Custom Bed - Chevy ... 225	Retainers w/ Screws 153
Park Light Assembly67	Pros Pick Custom Roll Pan - Chevy 225	Return Spring 208
Park Light Bulb-LED65	Pulley-Water Pump 44	Reverse Idler Gear 99
Park Light Installation Sheet ..236	Pushbutton 206	Reverse Polarity Switch51, 58
Part number information3	Pushrods 33	Revive Polish 16
Parts Book233		Ring & Pinion 105
Parts Interchange233		Rings 32
Passing Lamp Installation Sheet . 236	Q	Rocker Arm 33
Pedal Pad 178	Quality Control Card 239	Rocker Arm Shaft 33
Penetrating Oil21		Rocker Assembly 33
Picture Table of Contents 4, 5, 6, 7	R	Rocker Panel161, 164
Pinion Bearing 105	Radiator (Aluminum 42	Rocker Panel-Outer 167
Pinion Seal 105	Radiator (Copper-Brass) 42	Rod 31
Pin-Lock 110	Radiator Cap 42, 43, 151	Rod Bearing Shims 31
Pistons32	Radiator Core Support 171	Rod Bearings 31
Pitman Shaft 122	Radiator Hose Clamps 44	Rod Bolt & Nut 32
Pitman Shaft Seal 122	Radiator Hose Set 43	Rod Bolt Boots 32
Pivot Pin217	Radiator Insect Screen Installation Sheet 236	Roll Pan 143
Pivot Pins99	Radiator Petcock 43	Roller Bearing Conversion 140
Pivot Rubber Bushings202	Radio Manual 236	Rotor 58
Plastic Block 12	Radio Shop & Service Manual 237	RPO Booklet 235
Plastic Detail Spray 17	Radio Suppressor 199	RRK Re-ring Kit 30
Plastigauge31	Radio Tubes 199	RRK3 (Re-ring Kit w/ Main Bearings) 30
Plug 111, 176	Rear Axle Bearing 105	Rubber Bellows 99
Points58	Rear Axle Bearing & Seal 105	Rubber Boot80, 111
Polishing Ball 18	Rear Axle Cover 105	Rubber Bumpers 194, 195
Polishing Towel 18	Rear Axle Seal 105	Rubber Dressing 17
POR-15 Rust Preventive Paint .. 22	Rear Corner Cab Glass 214	Rubber Grommet 207
Positive Cable56	Rear Corner Glass Rubber ... 223	Rubber Plug 174
Power Window Conversion ...220	Rear Crossmember 230	Rubber Ring 121
Power Window Conversion Cable Driven220	Rear Leaf Spring 134	Running Board Bolt Kit 158
Power Window Conversion Gear	Rear Pan 162	Running Board Mat 158
	Rectangular Retaining Rubber 222	Running Board Step Plate 158
		Running Board To Cab Seal . 158

Providing part #'s speeds up your order, improves accuracy, and helps us maintain low prices.

See Illustration Index for core charge information and a list of abbreviations. For Body Model information, see 5T. 249



Index

Format = Part No., Year, Description, original Chevrolet Part Book Group No., Price and Unit Measure.

Running Boards w/ Built-in Mounting Points (Fiberglass) ... 159	Shackle Rebuild Kit 127, 133	Splash Apron-Front 143
Running Boards w/ Built-in Mounting Points (Fiberglass) ... 162, 166	Shackles 127	Splash Apron-Rear 145
Running Boards w/ Built-in Mounting Points (Steel) 159, 162, 166	Shackles-Rear 133	Splash Apron-Side 166
Rust Remover 20	Shift Fork 99	Spotlight 77
S	Shift Indicator (Flaming River) 118	Spotlight Bracket 70
Sales Brochure 235	Shift Knob 98, 186	Spotlight Card 240
Scaled Truck-GM Factory Promo 13	Shift Lever 100	Spotlight Handle 70
Screw 122	Shock Absorber Fluid 126	Spotlight Template 237
Screw Set 180, 194, 206, 209, 215, 223	Shock Conversion Kit 126	Spray Glaze 16
Screws 158, 174, 177, 207, 211	Shock Link 126	Spring 93, 109
Screws & Sleeve Nuts 219	Shocks 126, 133	Spring & Pivot Pins 99
Screws (Brass) 86	Shop 233	Stake Pockets 228
Screws-Mirror Arm 189	Shop Manual 233	Stand-Headlight Bucket 155
Screws-Sealed Beam Retainer Ring 73	Sign 240	Starter 51
Seal 144, 178	Single Action Shock 133	Starter Band 52
Sealed Beam Retainer Ring ... 73	Sleeves-(Metal) 35, 89	Starter Brush Set 51
Seal-Front Timing Cover 39	Small Crossmember 230	Starter Bushing 51
Seal-Rear Main 39	Small Parts Kit 100	Starter Drive 52
Seals 127	Soft Plug 100	Starter Pedal 177
Seals-Shackle 134	Soft Plug Set 35	Starter Pedal Return Spring 51
Seat Belts 181	Sound Deadener/ Insulation Kit ... 175	Starter Rebuild Kit 51
Seat Bumpers 182	Sound Deadener-Thermal Protection 22, 175, 176	Starter Rebuild Service 51
Seat Cover 183	Sound-Vibration Damping 176, 179	Starter Solenoid 51
Seat Frame 183	Spare Tire Carrier 232	Starter Solenoid Boot 51
Separator 108	Spark Plug Wire Set 57	Starter Solenoid Repair Kit 51
Service Bulletins 234	Spark Plugs 58	Starter Switch 51
Service Policy 240	Speedometer 191, 192	Steering Column Drop 118
Setting Tape 215	Speedometer Assembly 191	Steering Column Insulator 185
Setting Tape Door Glass 219	Speedometer Cable 100, 194	Steering Gear Overhaul Kit ... 121
	Speedometer Cable Kits (Lokar) . 98	Steering Shaft Support Bearing .. 121
	Speedometer Hand 194	Steering Shaft-Billet (Flaming River) 119
	Spindle Nut & Washer 139	Steering Shaft-Stainless (Flaming River) 119
	Splash Apron 159, 162	Steering Wheel 121
		Stool with Backrest 12
		Stool without Backrest 12

Returns require a return authorization number, please call.

Index



Format = Part No., Year, Description, original Chevrolet Part Book Group No., Price and Unit Measure.

Stove Bolt	34	Teflon Liner	134	Tri-Bar Headlight Cover-Blue Dot	71
Strap Bracket	215	Telescopic (Power) & Tilt Steering		Tri-Bar Headlight Cover-Chrome	
Striker	195	Column (Flaming River)	117	Bullet	71
Stud For Lug Nut	139	Terminal Boards	64, 73	Trim Clip	216
Studs In Manifold	92	Terminal Boot	86	Trim Ring	99, 177
Suburban Front Side Glass ...	214	Thermostat	45	Truck Body Parts - BITCHIN'	
Suburban Qtr Front Glass	214	Throttle Cable Assembly	186	Sheetmetal Parts	170, 171
Suburban Qtr Rear Glass	214	Throttle Cables (Lokar)	83	Truck Body Parts 1937-39	159,
Suburban Rear Side Glass ...	214	Throttle Knob	186	160,	161
Suburban/ Panel Tailgate/ Door		Throttle Return Spring	88	Truck Body Parts 1940-46	162,
Back Glass	214	Throw Mats	176	163,	164
Sunvisor	182, 237	Tie Rod End	122	Truck Body Parts 1947-54	165,
Sunvisor Assembly	182	Tilt Column Wiring Accessories		166,	167, 168, 169
Sunvisor-Exterior	165, 182	(Flaming River)	119	Truck Cover	18
Sway Bar	127	Tilt Steering Column-Column Shift		Tube	139
Swirl & Haze Remover	17	(Flaming River)	117	Tube Headers	91
Switch	69, 81	Tilt Steering Column-Floor Shift		Tube Shock Mounts	126, 133
		(Flaming River)	117	Turn Signal Flasher	65
T		Timing Gear	34	Turn Signal Flasher-LED ...	65, 76
Tail Light Assembly	79	Timing Hole Plug	35, 58	Turn Signal Harness	65
Tail Light Brackets	80, 81	Tinnerman Nuts	110, 139	Turn Signal Kit-No Harness	65
Tail Light Lens-Panel/ Suburban .		Tire - Black Wall, Bias Ply	139	Turn Signal Kit-W/ Harness	65
80		Tire - Black Wall, Radial	138	Turn Signal Knob	65, 185
Tail Light Pigtail	80	Tire - White Wall, Bias Ply	139	Turn Signal Switch	65
Tail Light-Panel/ Suburban	80	Tire - White Wall, Radial	138	Turntable	12
Tailgate	230, 231	Tires	138		
Tailgate - Custom	225	Tissue Dispenser	188	U	
Tailgate - Hidden Latch	226	Toe Board (Metal)	169	U-bolt	127, 134
Tailgate Chain Covers	232	Tool	104, 217, 223	U-clip	111
Tailgate Chains	232	Tool Bag	19	U-joint Assembly	103
Tailgate Cover	226	Tools-Body	19	U-joint Cross Assembly	103
Tailgate Decal	231	Tools-Engine, Drivetrain	19	U-joint Lock Plates	103
Tailgate Hinge	232	Tools-Interior	19	U-joints Stainless Steering	
Tailpipe	93	Torque Tube	103	Column (Flaming River)	120
Tailpipe Clamp	94	Traffic Light Viewer	185	U-joints--Billet-Joint Steering Box	
Tailpipe Hanger	93	Transmission Gasket Set	99	(Flaming River)	119, 120
Tailpipe Heat Shield	94, 230	Transmission Mount	100	U-joints--Billet-Joint Steering	
Tailshaft Bushing	99	Transmission Rebuild	100	Column (Flaming River)	120
Tank Straps	84				

Providing part #'s speeds up your order, improves accuracy, and helps us maintain low prices.

See Illustration Index for core charge information and a list of abbreviations. For Body Model information, see 5T. 251



Index

Format = Part No., Year, Description, original Chevrolet Part Book Group No., Price and Unit Measure.

U-joints--Stainless Steering Box (Flaming River) 120	Voltage Reducer 86, 191	Windshield Washer Nozzles . 202
Ultimate Noise Barrier Kit with Heatshield 175	Voltage Regulator 54, 55	Windshield Wiper Installation Sheet 237
Umbrella Holder Installation Sheet 237	W	Wing Nut 87
Underhood Lamp Installation Sheet 237	Warranty Card 240	Wiper Arm 203
Underhood Light 153	Watches 13, 14	Wiper Arm & Blade 203
Upholstery Batting 183	Water Pump 44	Wiper Arm & Blade (Billet) 200
Upper Hose 43	Water Pump Repair Kit 44	Wiper Blade 203
Utility Pocket Unit Installation Sheet 237	Wayne Push Rod Cover 35	Wiper Cap 201
V	Wayne Valve Cover 34	Wiper Control Link 202
Vacuum Advance 59	Weatherstrip Cement 212	Wiper Knob 185, 202
Vacuum Advance Line 89	Weatherstrip Clips 211	Wiper Motor Electric 200
Vacuum Hose 202	Wheel Cylinder Kit-Front 112	Wiper Motor Electric Kit 200
Valve 32	Wheel Cylinder Kit-Rear 112, 113	Wiper Motor Pivot Linkage Retainer 202
Valve & Rocker Cover Set 34	Wheel Cylinder-Front 111, 112	Wiper Motor-Vacuum Operated .. 203
Valve Cover Decal 240	Wheel Cylinder-Rear 112	Wiper Trans & Link Assy 203
Valve Cover-Acorn Nut 35	Windlace Retainer 211	Wire 63, 64, 70
Valve Cover-Chevy 6-Cylinder 34	Window Crank 221	Wire Assembly 70
Valve Cover-Grommets 35	Window Regulator 220	Wire Conduit 81
Valve Guide 32	Window Reveal Moulding 165	Wire Loom 63
Valve Seals 33	Window Shades 219	Wire Stop 187
Valve Seats 32	Window Stop Bumper 219	Wiring Harness 48
Valve Spring Cap 33	Window Wiper 219	Woodruff Keys 35
Valve Springs 33	Windshield Crank 185, 215	
Valve Stem Cap 137, 139	Windshield Divider 3651622 .. 215	
Valve Stem Locks 33	Windshield Divider Moulding . 180	
Vent Window Assembly 217	Windshield Frame 215	
Vent Window Handle 217	Windshield Frame Connecting Inserts 216	
Vent Window Rubber 217	Windshield Frame Seal 215	
VHT Hi-Temp Engine Enamel 22, 23	Windshield Glass 213, 214	
Vibrator 199	Windshield Moulding 215	
Voltage (Cut Out) 54	Windshield Regulator 215	
Voltage Booster 191, 197	Windshield Rubber 215	
	Windshield Rubber Bumper ... 215	
	Windshield Washer 240	
	Windshield Washer Hose 202	
	Windshield Washer Installation Sheet 237	

Returns require a return authorization number, please call.



Format = Part No., Year, Description, original Chevrolet Part Book Group No., Price and Unit Measure.

Customer Picture Index

Cunha, David	1954 1/2 Ton	41
Jacques, Paul & Kitty		52
Van Ryzin, Mike	1937 1/2 Ton	56
Unknown Owner	1940 Sedan Delivery	70
Unknown Owner		91
Unknown Owner	1950	102
Rice, Sid & Pat	1941 1/2 Ton	104
Tate, William	1950	106
Unknown Owner	1949	124
Reynolds, Gary	1946 1/2 Ton	146
Simmons, Robin	1941 1/2 Ton	157
Johnson, Ray	1951 Truck & Trailer	174
Peerman, Jack	1952 1/2 Ton	187
Lance, Rodger	1953	196
Pflugradt, Doug	1941	204
Harrison, Curt	1953 1/2 Ton 3100	221
Bryant, Don	1947 Suburban	222
Seabrook, Dave	1942 Military Truck	240-241

Providing part #'s speeds up your order, improves accuracy, and helps us maintain low prices.

See Illustration Index for core charge information and a list of abbreviations. For Body Model information, see 5T. **253**

CHEVS HISTORY...IN A NUTSHELL

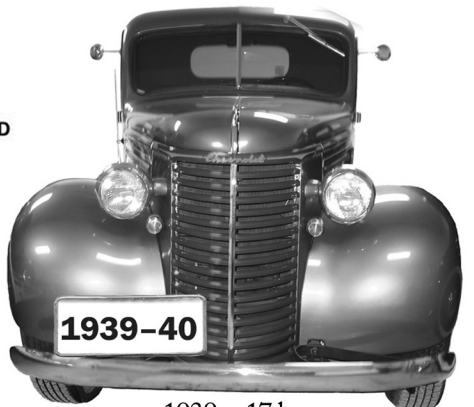
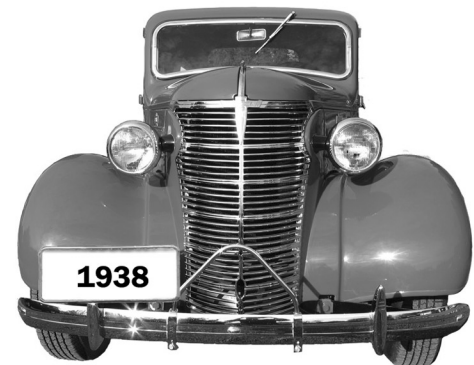
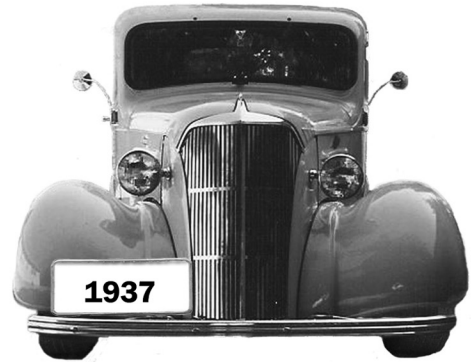
We're not your average parts house! We didn't buy a building, slap a name on it and say "We're Chevs of the 40's". Neither were we a planned business venture. President Ron Wade began restoring his 1941 Chevrolet Special Deluxe Cabriolet and found himself running in circles searching for the correct restoration parts. If he couldn't find it- he had it made. Many of the parts had to be ordered in such a large volume that he began placing classified ads selling the parts that nobody else offered.

So, where did he store all of these parts and pieces? Under the bed, on the fridge, in the rafters over the garage; virtually any place there was an empty hole in the house. That was over 20 years ago, now Chevs has over 10,000 square feet of shelf space, 14 full-time employees that run the day-to-day operation and the latest in computer technology. We are constantly researching the much needed, hard to find parts that everyone is looking for and if there's a demand, we will consider having them made. What was a rather limited supply of parts 20 years ago has turned into well over 8,000 different parts from which to choose.

A lot was learned restoring Ron's Cabriolet. Countless hours have been dedicated to having the correct parts made as well as improving the products we sell today. Ron's Cabriolet has over 50, yes fifty, factory accessories that have been collected and restored over the last 25 years. The accessories are worth more than the car itself!

At two shows entered, the 1941 Cabriolet took home "Best of Class" and "Best of Show" in the VCCA National Convention held in Springfield, Illinois. It also received "Best of Class" at the Forest Grove Concourse D'Elegance, and was one of three cars on the podium for "Best of Show". The "Best of Show" award went to a rare 1931 V16 Cadillac.

He didn't do it all himself— he had help! The restoration was performed by Bill Baker, the arrow— straight body & paint courtesy of Keith Grendahl, Ken Jones stitched up the leather upholstery while master technician Ray Holland provided all of the nitty-gritty details that make this car factory correct (not to mention the able assistance of the Chevs staff.)



1939 = 17 bars
1940 = 16 bars



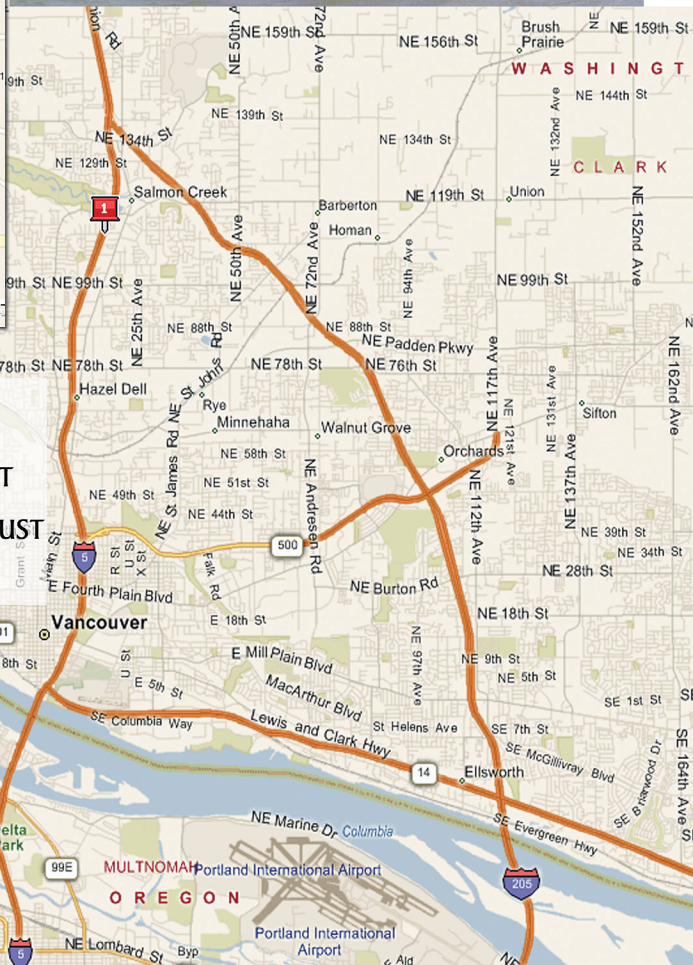
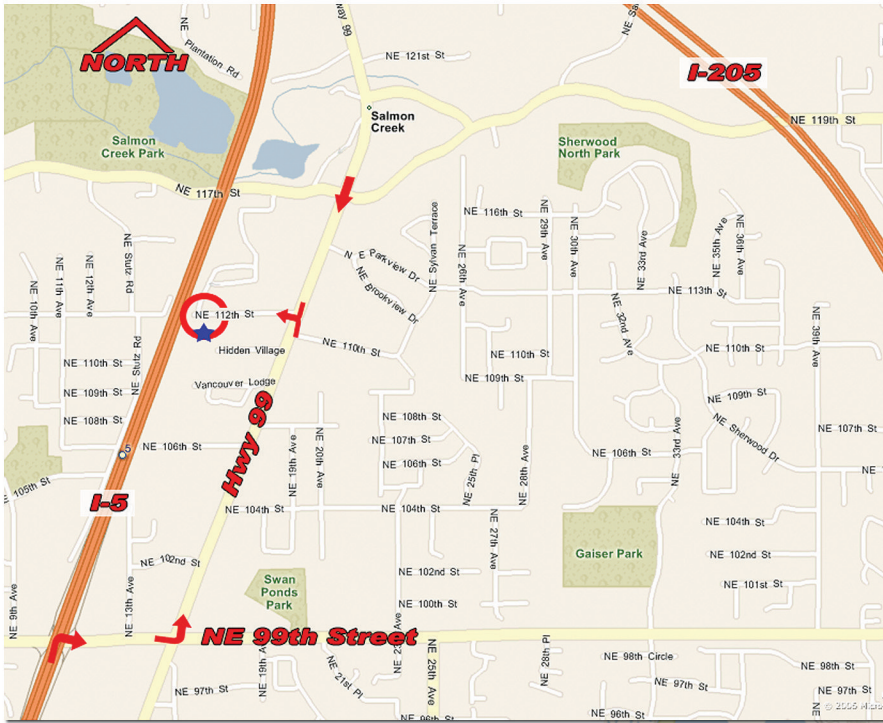
RON WADE'S AWARD WINNING 1941 CABRIOLET W/ OVER 50 ACCESSORIES

- AIR FILTER-OIL BATH
- ANTENNA-REEL
- ARMREST-CENTER
- BACK-UP LIGHT
- BEAUTY RINGS
- CLOCK-ELECTRIC
- COMPASS
- COWL VENT KNOB-IVORY
- CRANK SUPPORT-FRONT BUMPER
- CRANK-HAND
- DEFROSTER
- DRIVING LIGHTS
- EMERGENCY BRAKE WHISTLE
- EXHAUST TIP-SHARKS TAIL
- FENDER SKIRTS
- FLASHLIGHT
- FOLDDOWN REAR GUARD
- FOOT SCRAPER
- GAS CAP- "GM" LOCKING
- "GM" CAROMA
- GRILL-WINTERGUARD
- GRILLGUARD-BUMPER
- HEATER-SUPERDELUXE
- HOOD ORNAMENT-FLYING LADY
- HORN-TOWN & COUNTRY
- INITIAL HOLDER
- LICENSE FRAMES
- MIRROR-DAY/NIGHT
- MIRROR-LIGHTED VANITY
- MIRROR-RIGHT
- OIL FILTER
- RADIATOR SCREEN(OUTSIDE)
- RADIATOR-OVERFLOW TANK
- RADIO-AM & 4 SHORT WAVE BAND
- RADIO-POCKET PORTABLE
- REAR AXLE 3.70
- REAR FENDER GUARDS
- SPARETIRE INFLATOR
- SPOTLIGHT-LEFT & RIGHT
- STEERING WHEEL- SPINNER
- THERMOMETER
- TIRE PUMP
- TIRES-WHITEWALL
- TOOL KIT
- TURN SIGNALS
- UMBRELLA-SILK
- VALVE COVER BREATHER
- VISOR-CLIP ON
- WASHBOARDS-FRONT FENDER
- WHEEL DISKS & WINDSHIELD
- WASHERS.





**1605 NE 112th Street
Vancouver, WA 98686**



TO FIND *Chevs of the 40's*

NORTH I-205
134TH STREET EXIT
LEFT AT LIGHT
LEFT ONTO HIGHWAY 99 (NEXT LIGHT)
DOWN THRU THE VALLEY AND JUST
PRIOR TO CRESTING THE HILL,
RIGHT ON 112TH STREET

NORTH I-5
RIGHT OFF OF 99TH STREET EXIT
LEFT ON HWY 99
LEFT ON 112TH STREET
(JUST PRIOR TO GOING DOWNHILL TO
SALMON CREEK)

BUILDING ON LEFT SIDE, END OF STREET

SOUTH I-5
134TH STREET EXIT
STRAIGHT THRU THE LIGHT
RIGHT ONTO HIGHWAY 99 (NEXT
LIGHT)
DOWN THRU THE VALLEY AND JUST
PRIOR TO CRESTING THE HILL,
RIGHT ON 112TH STREET

West Coast Hours: Monday–Friday, 8:00 a.m.–5:00 p.m.
Shop online: www.chevs40s.com